

Keysight E6650A EXF Wireless Test Set for Femtocell

Notice: This document contains references to Agilent. Please note that Agilent's Test and Measurement business has become Keysight Technologies. For more information, go to www.keysight.com.

V9065B
Sequence
Analyzer
Measurement
Guide

Notices

© Keysight Technologies, Inc.
2009-2014

No part of this manual may be reproduced in any form or by any means (including electronic storage and retrieval or translation into a foreign language) without prior agreement and written consent from Keysight Technologies, Inc. as governed by United States and international copyright laws.

Trademark Acknowledgements

Bluetooth and the **Bluetooth logos** are trademarks owned by Bluetooth SIG, Inc., U.S.A. and licensed to Keysight Technologies, Inc.

cdma2000 is a US registered certification mark of the Telecommunications Industry Association.

LTE Logo and **LTE-Advanced Logo** are trademarks of ETSI.

See:

<http://www.3gpp.org/LTE-Logo-use>

Manual Part Number

E6650-90011

Print Date

October 2014

Supersedes: N/A

Published in USA

Keysight Technologies Inc.

1400 Fountaingrove Parkway

Santa Rosa, CA 95403

Warranty

THE MATERIAL CONTAINED IN THIS DOCUMENT IS PROVIDED “AS IS,” AND IS SUBJECT TO BEING CHANGED, WITHOUT NOTICE, IN FUTURE EDITIONS. FURTHER, TO THE MAXIMUM EXTENT PERMITTED BY APPLICABLE LAW, KEYSIGHT DISCLAIMS ALL WARRANTIES, EITHER EXPRESS OR IMPLIED WITH REGARD TO THIS MANUAL AND ANY INFORMATION CONTAINED HEREIN, INCLUDING BUT NOT LIMITED TO THE IMPLIED WARRANTIES OF MERCHANTABILITY AND FITNESS FOR A PARTICULAR PURPOSE. KEYSIGHT SHALL NOT BE LIABLE FOR ERRORS OR FOR INCIDENTAL OR CONSEQUENTIAL DAMAGES IN CONNECTION WITH THE FURNISHING, USE, OR PERFORMANCE OF THIS DOCUMENT OR ANY INFORMATION CONTAINED HEREIN. SHOULD KEYSIGHT AND THE USER HAVE A SEPARATE WRITTEN AGREEMENT WITH WARRANTY TERMS COVERING THE MATERIAL IN THIS DOCUMENT THAT CONFLICT WITH THESE TERMS, THE WARRANTY TERMS IN THE SEPARATE AGREEMENT WILL CONTROL.

Technology Licenses

The hardware and/or software described in this document are furnished under a license and may be used or copied only in accordance with the terms of such license.

Restricted Rights Legend

If software is for use in the performance of a U.S. Government prime contract or subcontract, Software is delivered and licensed as “Commercial computer software” as defined in DFAR 252.227-7014 (June 1995), or as a “commercial item” as defined in FAR 2.101(a) or as “Restricted computer software” as defined in FAR 52.227-19 (June 1987) or any equivalent agency regulation or contract clause. Use, duplication or disclosure of Software is subject to Keysight Technologies’ standard commercial license terms, and non-DOD Departments and Agencies of the U.S. Government will receive no greater than Restricted Rights as defined in FAR 52.227-19(c)(1-2) (June 1987). U.S. Government users will receive no greater than Limited Rights as defined in FAR 52.227-14 (June 1987) or DFAR 252.227-7015 (b)(2) (November 1995), as applicable in any technical data.

Safety Notices

CAUTION

A **CAUTION** notice denotes a hazard. It calls attention to an operating procedure, practice, or the like that, if not correctly performed or adhered to, could result in damage to the product or loss of important data. Do not proceed beyond a CAUTION notice until the indicated conditions are fully understood and met.

WARNING

A **WARNING** notice denotes a hazard. It calls attention to an operating procedure, practice, or the like that, if not correctly performed or adhered to, could result in personal injury or death. Do not proceed beyond a WARNING notice until the indicated conditions are fully understood and met.

Warranty

This Keysight technologies instrument product is warranted against defects in material and workmanship for a period of one year from the date of shipment. During the warranty period, Keysight Technologies will, at its option, either repair or replace products that prove to be defective.

For warranty service or repair, this product must be returned to a service facility designated by Keysight Technologies. Buyer shall prepay shipping charges to Keysight Technologies, and Keysight Technologies shall pay shipping charges to return the product to Buyer. For products returned to Keysight Technologies from another country, Buyer shall pay all shipping charges, duties, and taxes.

Where to Find the Latest Information

Documentation is updated periodically. For the latest information about these products, including instrument software upgrades, application information, and product information, browse to one of the following URLs, according to the name of your product:

<http://www.keysight.com/find/e6650a>

Information on preventing test set damage can be found at:

<http://www.keysight.com/find/PreventingInstrumentRepair>

Is your product software up-to-date?

Periodically, Keysight releases software updates to fix known defects and incorporate product enhancements. To search for software updates for your product, go to the Keysight Technical Support website at:

<http://www.keysight.com/find/techsupport>

What is the Sequence Analyzer? 9

Sequence Analyzer Introduction 10

Example Sequence: Equally Spaced Analysis Intervals 15

Example Sequence: Variable Analysis Intervals 17

Sequence Setup 19

Analyzer List Sequencer Parameter Definitions 21

Analyzer Sequence 22

Acquisition Parameters 23

Analysis Interval Parameters 31

Source List Sequencer Parameter Definitions 35

Source Sequence 36

Source Parameters 37

Coordinating the Sequencers 41

Include Source in Sequence is enabled 42

Include Source in Sequence is disabled 46

Mode Parameters 51

Mode and Measurement Parameters 52

List Sequencer Global Parameters 65

Advanced Setup Parameters 69

Test Set Parameters 75

Save and Recall 78

Front Panel Sequence Setup 81

Front Panel List Sequencer Setup 82

Front panel source sequence setup 92

Saving a Sequence 94

Importing a tsv file into a spreadsheet 96

List Sequencer Spreadsheet Data Entry 97

Tab separated value file 98

Spreadsheet setup 99

TSV file generation 103

Loading a tsv file into the List Sequencer 104

Tab separated value file editing 105

Contents

List Sequencer Measurement Results 107

Sequence Analyzer measurement results 108

Sequence Setup Commands 115

Programming Analyzer Sequences (Combination Commands) 116

Programming Analyzer Sequences (Parameter-Specific Commands) 119

Programming Source Sequences (Combination Command) 134

Programming Source Sequences (Parameter-Specific Commands) 136

Programming a Sequence 141

Sequence Programming Example 142

Example Test Scenarios 151

Non-Signaling Test Requirements 152

Calibration Example 153

Verification Example 159

Basic Measurements Programming Commands 177

Basic Transmit Power 178

Basic Frequency and Phase Error 181

Basic Discrete PAVT 183

Basic IQ Data 185

GSM/EDGE Programming Commands 187

GSM/EDGE Programming 188

GMSK Phase and Frequency (PFER) 189

GSM Loopback BER 192

EDGE Power vs. Time (PvT) 193

EDGE Error Vector Magnitude (EVM) 196

EDGE Output RF Spectrum (ORFS) 201

EDGE Loopback BER 205

W-CDMA Programming Commands 207

Adjacent Channel Power (ACP) 208

Spectrum Emissions Mask (SEM) 212

Occupied Bandwidth (OBW) 215

Modulation Accuracy 216

QPSK EVM 220

Code Domain Power (CDP) 223
Phase Discontinuity 225
Loopback BER 228

LTE-FDD Programming Commands 231

Adjacent Channel Power (ACP) 232
Spectrum Emissions Mask (SEM) 235
Occupied Bandwidth (OBW) 238
CEVM 239

LTE-TDD Programming Commands 253

Power vs. Time (PvT) 254
Adjacent Channel Power (ACP) 258
Spectrum Emissions Mask (SEM) 261
Occupied Bandwidth (OBW) 264
CEVM 265

TD-SCDMA Programming Commands 279

Power vs. Time (PvT) 280
Adjacent Channel Power (ACP) 285
Spectrum Emissions Mask (SEM) 288
Occupied Bandwidth (OBW) 291
Modulation Accuracy (Rho) 292
QPSK EVM 295
Code Domain Power (CDP) 298
Loopback Bit Error Rate (BER) 300

WLAN Programming Commands 301

Spectrum Emissions Mask (SEM) 302
Occupied Bandwidth (OBW) 305
Modulation Accuracy (EVM & Spectral Flatness) 306
MIMO Modulation Accuracy (EVM) 310

1 What is the Sequence Analyzer?

This chapter provides a basic introduction to the Sequence Analyzer mode.

The chapter topics are:

[Sequence Analyzer Introduction](#)

[Sequence Setup](#)

Sequence Analyzer Introduction

The Sequence Analyzer mode makes it possible to define, save, and execute a series of data acquisitions (controlled by the analyzer list sequencer) and/or a series of RF stimulus outputs (controlled by the source list sequencer). This defined series of acquisitions and/or outputs is known as a sequence.

The two list sequencers operate independently; however, they can exchange trigger signals with one another, and they can both be controlled by the same sequence.

Figure 1-1 Source and Analyzer List Sequencers

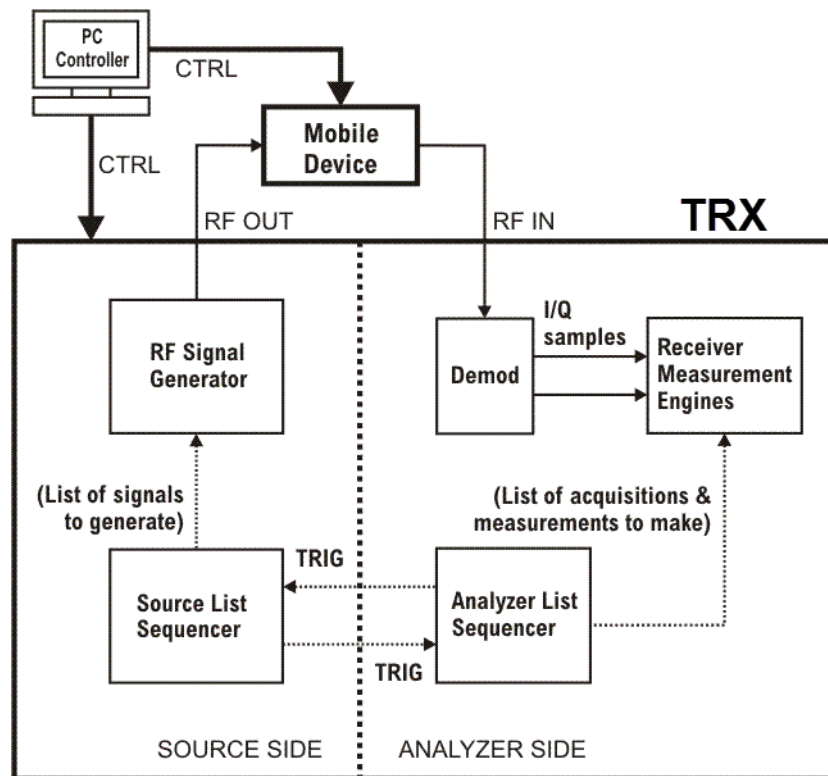

Because one sequence can control both list sequencers, launching a sequence is all that is necessary to cause the test set to (1) make a set of data acquisitions, (2) make measurements on each acquisition, and (3) generate whatever RF stimulus is needed during each measurement.

Sequences are typically used in calibration and/or verification of a mobile device. The test set generates the signals that are expected by the mobile device receiver, and analyzes the signals that the mobile device transmits in response. This method of interacting with the mobile device saves test time, because it does not involve any call processing (the test set and the mobile device only need to exchange a predefined set of signals).

The Sequence Analyzer mode combines speed with flexibility. All of the actions controlled by the sequence are executed rapidly and without interruption, even if the measurements involved use different radio standards. (For example, it is possible to switch from an EDGE EVM measurement to a W-CDMA SEM measurement without stopping the sequence and starting a new one.)

Parameter definitions associated with the source and analyzer list sequencers are defined in [Chapter 2, “Analyzer List Sequencer Parameter Definitions”, on page 21](#) and [Chapter 3, “Source List Sequencer Parameter Definitions”, on page 35](#).

NOTE The analyzer list sequencer uses measurements from other applications on the test set, and all licensing requirements apply to these applications when they are used in Sequence Analyzer mode. For example, to make W-CDMA measurements within the analyzer list sequencer, the W-CDMA U9073A application must be licensed on the test set.

What is the Sequence Analyzer? Sequence Analyzer Introduction

Analyzer List Sequencer

The analyzer list sequencer provides a large amount of flexibility in the capture of an RF signal and the number of measurements that can be made. Because of this, there are many parameters that the user can set up to suit particular measurement requirements. The parameters are described in detail in [Chapter 2](#). In this section, the higher level concepts are explained with the use of sequence examples.

A sequence for the analyzer list sequencer defines one or more data acquisitions (conventionally represented by a red bar in diagrams). The sequence also defines, within each acquisition, one or more analysis intervals (time windows for measurement, conventionally represented by a blue bar in diagrams). [Figure 1-2](#) shows an example of a sequence with two acquisitions (each of which contains several analysis intervals).

Figure 1-2 Data Sequence

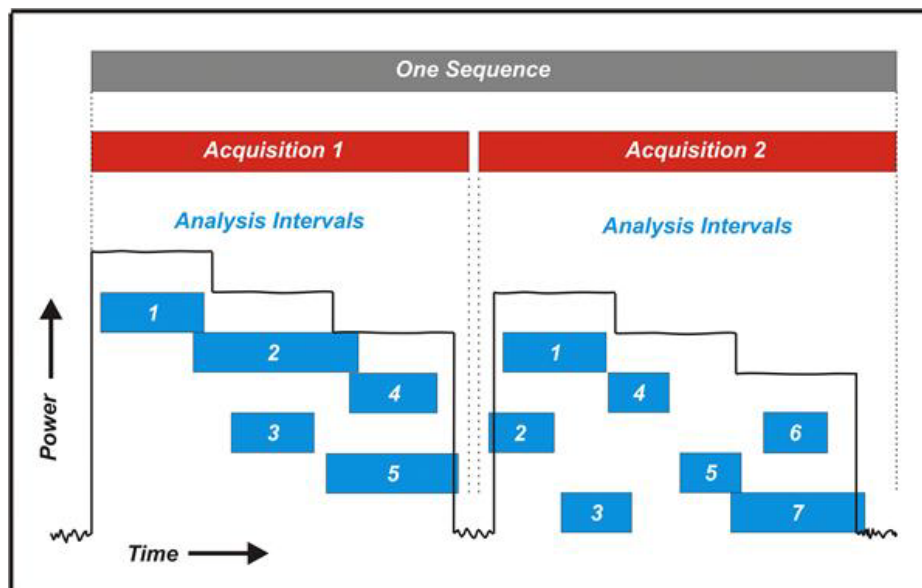

Although one acquisition must end before the next acquisition in the sequence can begin, the analysis intervals within a given acquisition can overlap as needed. The start and stop times for an analysis interval can be placed anywhere within the acquisition, so that the measurements associated with that analysis interval are made only on the desired portion of the acquired data. In this example, the power level of the measured signal is being stepped downward during the acquisitions, and the analysis intervals are defined so that some of them occur during a period of unchanging power, while others include a rising or falling edge.

The need to start a new acquisition arises when there is a change to any of the settings which have been defined for that acquisition (radio standard, radio band, and so on). If no such changes are made, a single acquisition is sufficient for the entire sequence.

The need for more than one analysis interval typically arises when two measurements cannot use the same start and stop times. If one time window within an acquisition is acceptable for all measurements, a single analysis interval is usually sufficient for the entire acquisition.

User-defined parameters for the sequence determine various important characteristics of the acquisitions (for example, the frequency of the acquired signal) and of the analysis intervals (for example, the type and timing of measurements).

A sequence is saved as a file of tab-separated values representing sequence parameters. The parameters that are used by the analyzer list sequencer (rather than the source list sequencer) are placed in the file under the heading: `### Analyzer ###`.

The parameters which define an acquisition are placed on one line, followed by one or more lines of parameters for the analysis intervals within that acquisition. When a sequence is created in a spreadsheet, the analysis-interval parameters are placed in columns to the right of the acquisition parameters, as illustrated in **Figure 1-3** (When a sequence is saved, leading tabs are inserted into the lines of analysis-interval parameters, to preserve this spreadsheet format.) In the illustration, there are two acquisitions (shown in red), of which the first has two analysis intervals (shown in blue) and the second has four analysis intervals.

Figure 1-3 Basic Elements of an Analyzer Sequence

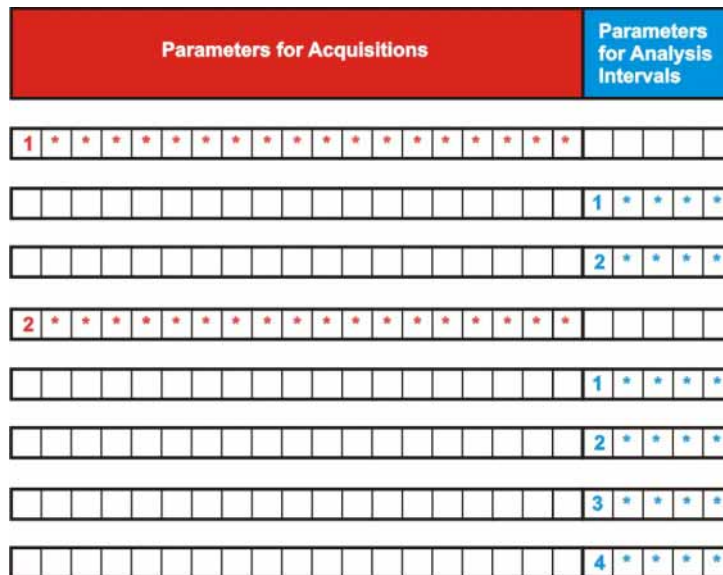

In a saved sequence, an acquisition with two analysis intervals would be represented by three lines of parameters in the file (tabs are represented here by ">"):

```
### Analyzer ###
```

```
1 > GSM > NONE > BTS > 1000 > 1 > 0 > LOW > 0.5 > 4.55 > VIDeo > -6.5 > -0.2 > NONE > -10  
> OFF > OFF > NORMAl > RFInput
```

```
> > > > > > > > > > > > > > > > > > 1 > 0.0 > 0.845 > 111 > -4.3
```

```
> > > > > > > > > > > > > > > > > > 2 > 1.009 > 0.962 > 11 > -12.9
```

The parameters are described in detail in **Chapter 2**.

What is the Sequence Analyzer?
 Sequence Analyzer Introduction

Source List Sequencer

The signal generator (on the source side of the test set) is used to produce RF stimulus waveforms for use in calibrating and testing mobile devices. The Source List Sequencer can be used to execute a series of stimulus operations, in either of two ways:

In the Sequence Analyzer mode, the source list sequencer is run by the same sequence which is also running the analyzer list sequencer. (This is the only way to run both list sequencers at the same time.) In this case, the lines representing the source sequence parameters are added to the sequence following the analyzer sequence parameters, as illustrated below in **Figure 1-4**)

Outside the Sequence Analyzer mode, the source list sequencer can be run independently of the analyzer list sequencer. (This is can be done from the front panel of the test set by selecting “List Sequencer” on the Source menu.)

Figure 1-4 Source Parameters Within a Combined Sequence

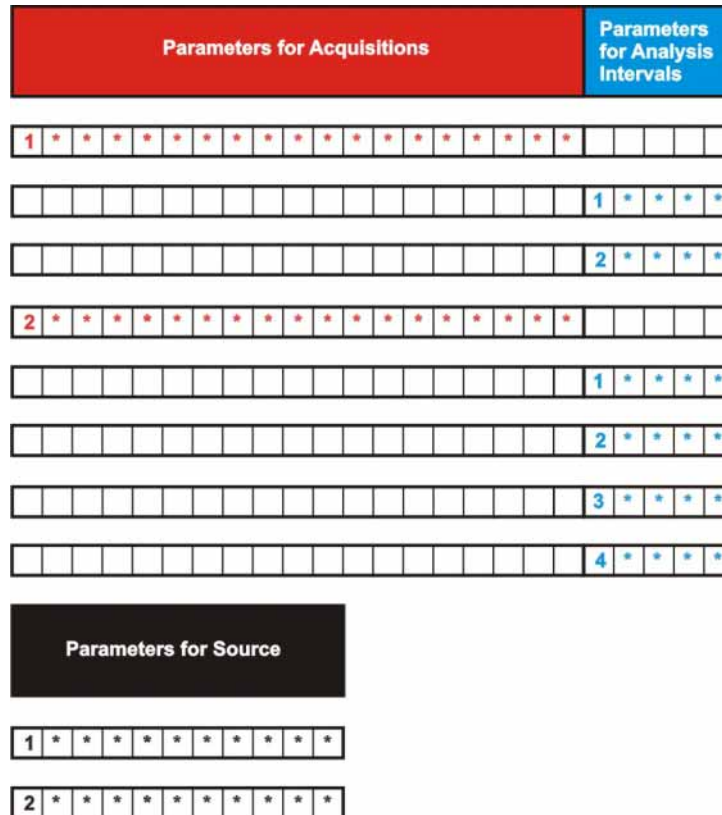

For example, two stimulus steps would be represented by two lines of parameters in the sequence file (tabs are represented here by “>”):

Source

```
1 > IMM > 1 > PGSM > UP > 30 > -55 > gmsk.wfm > TIME > 4.62 > NONE
2 > IMM > 1.33 > PGSM > UP > 31 > -35 > CONT > COUNT > 13 > NONE
```

The parameters for the source are described in **Chapter 3**. For more detailed information on setting up the source List Sequencer refer to the Source User’s Guide, which is available as a pdf on the test set and on the Keysight web.

Example Sequence: Equally Spaced Analysis Intervals

To help further clarify the concepts of sequences, acquisitions and analysis intervals, an example of a calibration sequence is shown in **Figure 1-5**. A spreadsheet is used to set up the sequence, acquisition and analysis interval parameters and subsequently generate a tab separated file which is loaded into the list sequencers. The use of the spreadsheet is defined in **Chapter 7** but in this chapter it is used to help explain the Sequence Analyzer concepts. The spreadsheet associated with this example is shown in **Figure 1-6**

In the diagram in **Figure 1-5**, a sample sequence of data is shown that could be used for calibrating a mobile device. The data consists of a PGSM signal on Channel 1, which is stepped in down in power (from -5 dBm to -47 dBm) over 15 steps. The radio standard is then changed to EGSM on Channel 1, and the power is stepped down over another 15 steps. The radio standard is then changed back to PGSM, but on Channel 2, and the power is stepped down again. Finally, the radio standard is changed to EGSM on Channel 2, and the power is stepped down again.

Figure 1-5 Sequence with Equally Spaced Analysis Intervals

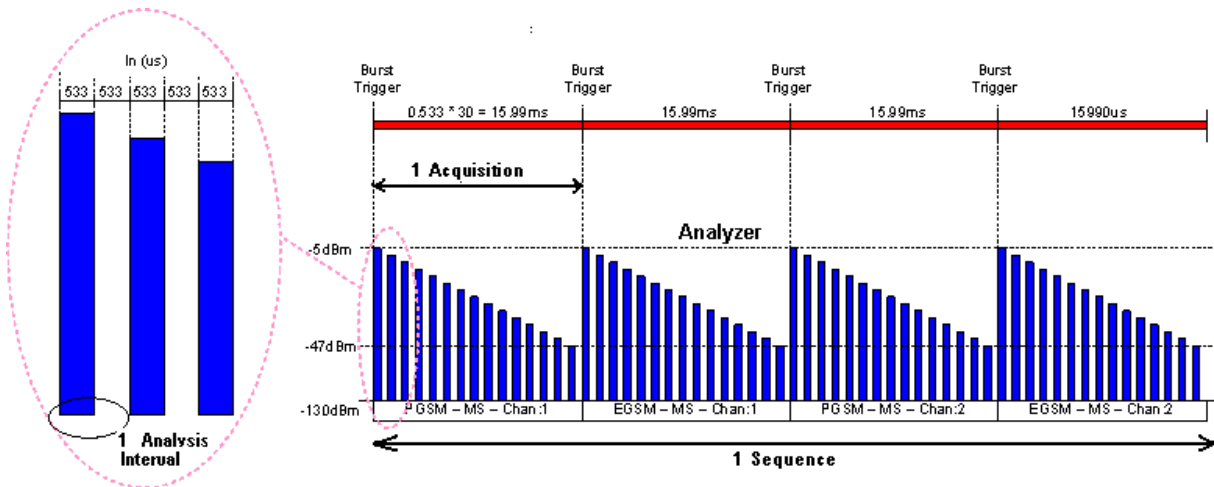

The analyzer sequence which prepares the test set to receive this set of data must be divided into four acquisitions (one for each of the four radio standard/channel combinations). Each of the four acquisitions, in turn, must be divided into 15 analysis intervals (one for each of the 15 power levels at which measurements will be made).

A spreadsheet defining this example sequence is illustrated in **Figure 1-6 on page 16**.

What is the Sequence Analyzer?

Example Sequence: Equally Spaced Analysis Intervals

Figure 1-6 Sequence Spreadsheet

Acq Number	Radio Standard	Radio Band	Device	Freq (MHz) Chan	Number of Averages	Power Power (dBm)	Int Gain Type	Transmit Tones(s)	Acquisition Duration (ms)	Input Trigger Type	Input Trigger Level	Input Trigger Delay (ms)	Acquisition Output Trigger	Int Gain LDO Voltage (dB)	Highpass Filter Input Port	Highpass Filter Present	Acquisition Integration	Acq I/F Input Port	Analysis Start Number	Analysis Stop Offset (ms)	Analysis Stop Interval (ms)	Measurement Bitmap	Exp Power at DUT Output (dBm)
1	GSM	PGSM	BTS	1	1	0	LOW	5	0.72	VIDEO	-10	0	Internal	-20	OFF	OFF	NORMAL	RFInput	1	0	0.533	10101	-5
																			2	1.0	0.533	10101	-8
																			3	2.1	0.533	10101	-11
																			4	3.2	0.533	10101	-14
																			5	4.3	0.533	10101	-17
																			6	5.3	0.533	10101	-20
																			7	6.4	0.533	10101	-23
																			8	7.5	0.533	10101	-26
																			9	8.5	0.533	10101	-29
																			10	9.6	0.533	10101	-32
																			11	10.7	0.533	10101	-35
																			12	11.7	0.533	10101	-38
																			13	12.8	0.533	10101	-41
																			14	13.9	0.533	10101	-44
																			15	14.9	0.533	10101	-47
2	GSM	PGSM	BTS	1	1	0	LOW	5	0.72	VIDEO	-10	0	Internal	-20	OFF	OFF	NORMAL	RFInput	1	0	0.533	10101	-5
																			2	1.0	0.533	10101	-8

The first row of entries in the spreadsheet sets up the acquisition settings (as represented by the first 19 parameters in the row) for the first acquisition. For example, “1” in the first column specifies that this is the first acquisition in the sequence, “PGSM” in the third column specifies the radio band, and “1” in the fifth column specifies the channel number.

Under this row are 15 rows setting up the analysis intervals (that is, the measurement time windows) within the first acquisition. For each of these, the first 19 parameters are left blank, because these define the acquisition, and remain unchanged until the next acquisition begins. Only the last five parameters in the row define the analysis intervals. For example, the 2nd parameter sets the start time for the interval (as an offset from the start of the acquisition), and the 3rd parameter sets the length of the interval (in this example, it is consistently 0.533 ms). The 4th parameter is a bit map value which defines the selection of measurements to be made (see “4: Measurement Bitmap” on page 32). The 5th parameter specifies an expected DUT output power level for each interval (this value is used to establish pass/fail criteria for Basic Transmit Power tests, and to ensure that the Instrument Gain setting is not set too high for the test input to safely receive the DUT signal).

Following the 15 rows defining the analysis intervals for the first acquisition, a new row sets up the parameters for the second acquisition, and is followed by more rows defining the analysis intervals for that acquisition.

The parameters for the analyzer list sequencer are described in more detail in [Chapter 2](#).

In this simple example, the analysis intervals are spaced evenly across the acquisition, and each analysis interval includes the same measurements. The following example shows how analysis intervals can overlap as necessary to capture specific sections of data for different measurements.

Example Sequence: Variable Analysis Intervals

Figure 1-7 shows an example of a data sequence that has three bursts of data. Each burst is at a different frequency; therefore, three different acquisitions must set up in the analyzer list sequencer to capture this data. The associated spreadsheet is shown in **Figure 1-8**. Each acquisition starts at the burst trigger, because the Input Trigger Delay parameter has been set to zero for each acquisition.

As shown in **Figure 1-7**, the first acquisition has a duration of 0.72 ms, and includes only one analysis interval. The interval starts 0.02 ms after the burst trigger, and lasts for 0.7 ms. These values are entered in the spreadsheet as shown in **Figure 1-8**. Also entered there is a Measurement Bitmap value of 111 (indicating that the measurements done on this analysis interval are the three basic measurements of Transmit Power, Phase Error and Frequency Error).

The second acquisition has a duration of 0.74 ms, and includes two analysis intervals rather than one. The first analysis interval is offset from the start of the acquisition by 0.195 ms and is 0.1 ms in duration. The measurements are the same as for the previous acquisition (that is, the Measurement Bitmap value is 111 again). However, for the second analysis interval (which is offset from the start of the acquisition by 0.445 ms and has a duration of 0.1 ms), the Measurement Bitmap value is 11 (indicating that the measurements performed on this data are Basic Transmit Power and Basic Phase Error).

Figure 1-7 Sequence with Variable Analysis Intervals

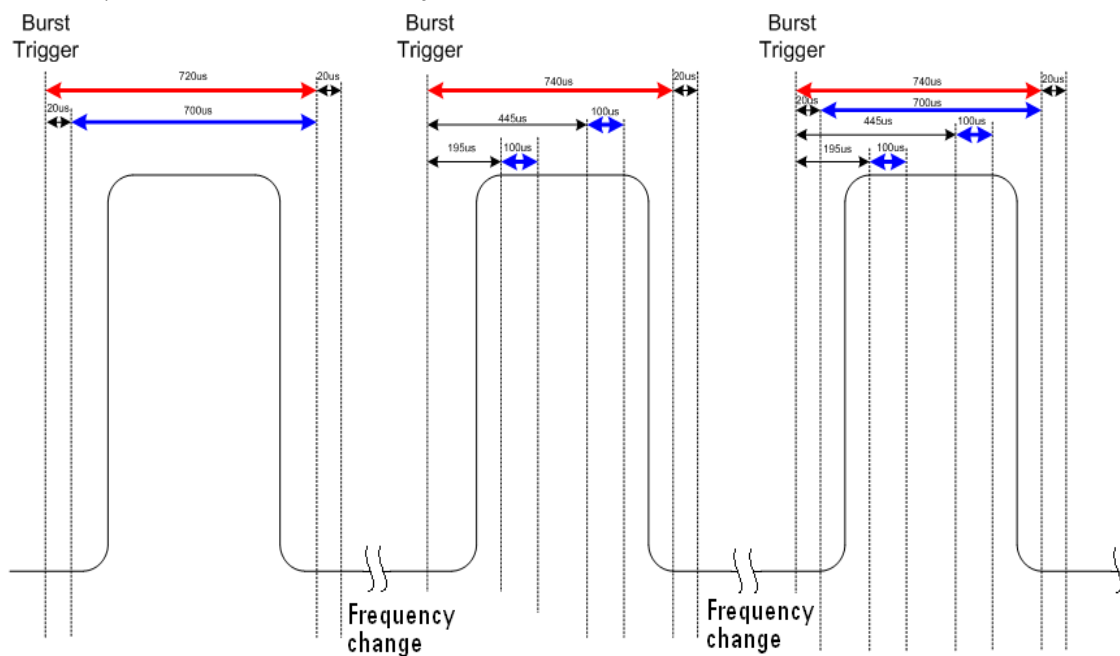

The third acquisition has a duration of 0.74 ms, and includes three analysis intervals which happen to overlap in time. The first analysis interval is offset 0.02 ms from the start of the acquisition and lasts 0.7 ms, during which time the basic measurements of Transmit Power, Phase Error and Frequency Error are done (Measurement Bitmap value 111). The second analysis uses some of the same data used in the first analysis; it is offset 0.195 ms after the start of the acquisition and lasts 0.1 ms, during which time the basic measurements of Transmit Power and Phase Error are done

What is the Sequence Analyzer?

Example Sequence: Variable Analysis Intervals

(Measurement Bitmap value 11). The third analysis interval is offset 0.445 ms from the start of the acquisition, and lasts for 0.1 ms, during which time the basic measurements of Transmit Power, Phase Error, Frequency Error, and IQ Data are made (Measurement Bitmap value 1111).

Figure 1-8 Sequence Spreadsheet

Seq Number ***	Radio Standard	Radio Band	Device	Freq (MHz) Chan	Number of Averages	Final Power (dBm)	Test Set Type	Testset Time (ms)	Acquisition Duration (ms)	Input Trigger Type	Input Trigger Level	Input Trigger Delay (ms)	Acquisition Offset (ms)	Test Set LDP Value (dB)	Multiple Adj Input Port	Release Adapt Power	Acquisition Integration	Acq RF Input Port	Analysis Step Number	Analysis Step Duration	Analysis Step Interval (ms)	Measurement Bitmap	End Power at Offset (dB)
1	GSM	PGSM	BTS	1	1	0	LOW	5	0.72	Video	-10	0	Normal	-20	OFF	OFF	NORMInt	RFInput	1	0	0.533	10101	5
																			2	1.0	0.533	10101	8
																			3	2.1	0.533	10101	11
																			4	3.2	0.533	10101	14
																			5	4.3	0.533	10101	17
																			6	5.3	0.533	10101	20
																			7	6.4	0.533	10101	23
																			8	7.5	0.533	10101	26
																			9	8.5	0.533	10101	29
																			10	9.6	0.533	10101	32
																			11	10.7	0.533	10101	35
																			12	11.7	0.533	10101	38
																			13	12.8	0.533	10101	41
																			14	13.9	0.533	10101	44
																			15	14.9	0.533	10101	47
2	GSM	PGSM	BTS	1	1	0	LOW	5	0.72	Video	-10	0	Normal	-20	OFF	OFF	NORMInt	RFInput	1	0	0.533	10101	5
																			2	1.0	0.533	10101	8

Sequence Setup

There are a number of ways to set up a Sequence in the test set. The possibilities are described in these chapters:

Front panel setup - see **Chapter 6, “Front Panel Sequence Setup”, on page 81**

Spreadsheet setup - see **Chapter 7, “List Sequencer Spreadsheet Data Entry”, on page 97**

Remote setup - see **Chapter 10, “Programming a Sequence”, on page 141** for an example of how to write a program to set up a Sequence.

See the following chapters for programming commands which are specific to the Sequence Analyzer.

Chapter 12, “Basic Measurements Programming Commands”, on page 177

Chapter 13, “GSM/EDGE Programming Commands”, on page 187

Chapter 14, “W-CDMA Programming Commands”, on page 207

Chapter 15, “LTE-FDD Programming Commands”, on page 231

Chapter 16, “LTE-TDD Programming Commands”, on page 253

Chapter 17, “TD-SCDMA Programming Commands”, on page 279

Chapter 18, “WLAN Programming Commands”, on page 301

Also, for a more complete SCPI command reference information, refer to the Sequence Analyzer online help which is available on the test set and also available in pdf format as the “User’s and Programmer’s Reference” on the C drive of the test set in the C:\Program Files\Agilent\SignalAnalysis\Infrastructure\Help\bookfiles directory.

To find out how to set up the test set to perform measurements in modes other than the Sequence Analyzer, refer to the equivalent measurement guides for the modes on the X-series analyzers which are available at:

<http://www.keysight.com/find/mxa>

These measurement guides contain the required procedural information

Be aware that the X-series analyzer measurement guides refer to a separate analyzer and signal generator. For the case of the Keysight EXF test set, the signal generator capability is available on the test set, so the setup procedures should be adjusted accordingly.

For programming information for the other modes on the test set, refer to the mode online help which is available on the test set and also available in pdf format as the “User’s and Programmer’s Reference” on the C drive of the test set in the C:\Program Files\Agilent\SignalAnalysis\Infrastructure\Help\bookfiles directory.

General programming for the X-series products is documented in the X-series programming guide.

What is the Sequence Analyzer?
Sequence Setup

2 Analyzer List Sequencer Parameter Definitions

This chapter describes the parameters that are used in the setup of the analyzer list sequencer. (The analyzer and source list sequencers can exchange triggers, but are otherwise configured independently.)

The chapter topics are:

- [Analyzer Sequence](#)
- [Acquisition Parameters](#)
- [Analysis Interval Parameters](#)

Analyzer Sequence

In the case of the analyzer list sequencer, a sequence is defined as a series of one or more data acquisitions, each with its own set of measurements to be performed. A sequence is set up so that all the data needed for the calibration or verification of a device is acquired, and all the required measurement results are returned in the shortest time possible.

The Sequence allows for the possible wide variation in the parameters of an RF signal from a device under test. These parameters include frequency and power level. The Sequence also provides user-specification of measurement triggering and detailed specification of the timing over which measurements take place. To allow for range variations in the frequency and power level the Sequence may need to be divided into a series of data acquisitions; an Acquisition is defined in the next section.

There are global parameters associated with a Sequence that must be defined for each Sequence. The following sections define these parameters. For more information about the parameters and their remote control commands, refer to the Sequence Analyzer online help (or in pdf format, the User's and Programmer's Reference). Information about how to set these parameters from the front panel and remotely is provided in ["Front Panel List Sequencer Setup" on page 82](#) and ["Set up the List Sequencer measurement parameters" on page 144](#).

The measurements within a Sequence that are available are detailed in the following chapters:

- [Chapter 12, "Basic Measurements Programming Commands", on page 177](#)
- [Chapter 13, "GSM/EDGE Programming Commands", on page 187](#)
- [Chapter 14, "W-CDMA Programming Commands", on page 207](#)
- [Chapter 15, "LTE-FDD Programming Commands", on page 231](#)
- [Chapter 16, "LTE-TDD Programming Commands", on page 253](#)
- [Chapter 17, "TD-SCDMA Programming Commands", on page 279](#)
- [Chapter 18, "WLAN Programming Commands", on page 301](#)

Acquisition Parameters

Acquisitions, as successive steps in a sequence, make it possible to capture data which varies in frequency, in power range, and in other characteristics which may require changes to the configuration of the test set.

This section describes the 19 parameters which configure the test set for a single acquisition. A change to any of these parameters can be made only by starting a new acquisition; therefore, the number of acquisitions in the sequence is determined by the number of times that a change is made to one or more of these parameters. (A single acquisition would be enough for the entire sequence, if none of these parameters changed.)

An additional 5 parameters are used to define analysis intervals within an acquisition, and those parameters can be changed repeatedly without starting a new acquisition, as described in **“Analysis Interval Parameters” on page 31**.

NOTE The Sequence Analyzer application is also used in other Keysight test sets, and includes some acquisition parameters which pertain only to other test sets. Parameters which are not pertinent to the EXF test set, as noted below, are ignored, but they are not omitted in sequences, because individual parameters are recognized by the order in which they are listed.

The parameters which cannot change during an acquisition are described below.

1: Acq Number

Acquisitions are numbered sequentially (1 through n), and executed sequentially. One acquisition must end before the next acquisition begins.

2: Radio Standard

This parameter specifies a radio standard to be used by the test set's analyzer for the received signal during the acquisition. The choices are as follows (for a fixed frequency, select NONE):

- NONE
- GSM
- EDGE
- WCDMA [W-CDMA]
- LTE [LTE FDD]
- LTETDD [LTE TDD]
- TDSCDMA
- WLAN

Regardless of which choice is made, four basic measurement results (Basic Transmit Power, Basic Frequency and Phase Error, Basic Discrete PAVT, and Basic IQ data) are always available. The availability of other measurements depends upon the radio standard selected here, as explained in connection with Measurement Bitmap (the 20th parameter for the sequence).

The key path for selecting the Radio Standard from the front panel menus is:

[Meas Setup], Acquisition Setup, Radio Setup, Radio Standard

NOTE A particular radio standard will be available here only if the application for the associated measurement mode (GSM, for example) is currently loaded.

3: Radio Band

This parameter specifies a radio band appropriate to the radio standard specified in the previous parameter. The choices are outlined below.

Table 2-1 Values for Radio Band Parameter

Radio Standard	Radio Band
NONE	NONE
GSM or: EDGE	NONE, PGSM, EGSM, RGSM, DCS1800, PCS1900, GSM450, GSM480, GSM850, GSM700, TGSM810
WCDMA	NONE, BANDI, BANDII, BANDIII, BANDIV, BANDV, BANDVI, BANDVII, BANDVIII, BANDIX, BANDIX, BANDX, BANDXI, BANDXII, BANDXIII, BANDXIV, BANDXIX
LTE FDD	NONE, BAND1, BAND2, BAND3, BAND4, BAND5, BAND6, BAND7, BAND8, BAND9, BAND10, BAND11, BAND12, BAND13, BAND14, BAND17, BAND18, BAND19, BAND20, BAND21, BAND24, BAND25, BAND26, BAND27, BAND28, BAND31
LTE TDD	BAND33, BAND34, BAND35, BAND36, BAND37, BAND38, BAND39, BAND40, BAND41, BAND42, BAND43, BAND44
TD-SCDMA	BANDA, BANDB, BANDC, BANDD, BANDE, BANDF

The key path for selecting the Radio Band from the front panel menus is:

[Meas Setup], Acquisition Setup, Radio Setup, Radio Standard, <select standard, then band>

4: Device (for Channel)

This parameter is used by the analyzer to determine the channel plan to be used when computing the Frequency/Channel values. The choices are BTS (Base Transceiver Station) and MS (Mobile Station). However, in the EXF test set, measurements are supported only for base stations; therefore, BTS should always be selected.

The key path for selecting the Device from the front panel menus is:

[Meas Setup], Acquisition Setup, Radio Setup, Device

5: Frequency / Channel

This parameter sets up the analyzer to match the frequency of the received signal. If the radio standard is other than NONE, this parameter specifies a channel number appropriate to the radio standard, radio band, and device specified in the previous three parameters. If the radio standard is specified as NONE, this parameter specifies frequency in MHz.

The key path for setting the Frequency or Channel from the front panel menus is:

[Meas Setup], Acquisition Setup, Frequency [or Channel]

6: Number of Averages

This parameter determines the number of averages (N) for the acquisition. If N is greater than 1, the analysis intervals for the acquisition are repeated N times, the acquisition period is extended to accommodate those repetitions, and the measurement results for the repeated analysis intervals are averaged from all repetitions.

Repetition of analysis intervals does not require re-triggering. The acquisition is still triggered only once.

The key path for setting the Average Count from the front panel menus is:

[Meas Setup], Acquisition Setup, Avg Number

NOTE The Number of Averages must not be greater than one when the Measurement Bit Mask (page 32) includes Basic IQ Data.

7: Peak Power

This parameter specifies the highest power level that will be received from the DUT during this acquisition, in dBm. The information is used by the Auto Set RF Level algorithm to determine the upper limit of the dynamic range.

The key path for selecting the Peak Power from the front panel menus is:

[Meas Setup], Acquisition Setup, Peak Power

8: Instrument Gain Type

This parameter specifies one of three possible settings which control the input gain of the test set (LOW, ZERO, or HIGH).

NOTE This sequence parameter is used by some Keysight models for which Auto Set RF Levels can be on or off. For E6650A, Auto Set RF Levels is always on, and the test set automatically selects this setting for the acquisition, so the value of this parameter is ignored by the sequencer.

9: Transition Time

This parameter specifies a settling-time period which is required between acquisitions, in ms. This period begins after the time set by the Acquisition Duration parameter, and allows enough time for any power and frequency changes which are needed for the next acquisition.

NOTE Although different time units can be used in setting transition time from the front panel, the parameter value as entered in the sequence is always in ms.

The transition time needed depends on which acquisition parameters are changing between acquisitions. In most situations, the following suggested values provide adequate transition time.

Changes to instrument gain require a 0.02 ms transition.

Within-band frequency changes require a 0.3 ms transition.

Cross-band frequency changes require a 1 ms transition. The bands are:

- Frequency Band 1: -0.08 GHz to 0.6075 GHz
- Frequency Band 2: 0.5075 GHz to 2.1775 GHz
- Frequency Band 3: 2.0775 GHz to 3.6 GHz

If necessary, add more time to allow for the device under test to change states. If the value entered is insufficient for the power and frequency changes involved, the sequence will generate an error message asking for more transition time.

The key path for setting the Transition Time from the front panel menus is:

[Meas Setup], Acquisition Setup, Transition Time

10: Acquisition Duration

This parameter sets the total time for the acquisition (that is, the interval during which the test set is acquiring IQ samples); the range is 0 to 10 seconds.

If a pre-trigger is set, then the acquisition duration includes the pre-trigger time. A pre-trigger is set by setting a negative Input Trigger Delay. For no-measurement acquisitions (which are used only to coordinate the triggering of the test set's source and analyzer) the Duration should be set to minimum, and the Meas Bitmap for the single analysis step in the acquisition should be set to zero. The acquisition Transition Time should then be set to the remaining time that is required for the no-measurement acquisition.

NOTE Although different time units can be used in setting the acquisition duration from the front panel, the parameter value as entered in the sequence is always in ms.

The key path for setting the Acquisition Duration from the front panel menus is:

[Meas Setup], Acquisition Setup, Acquisition Duration

11: Input Trigger (also known as Input Trigger Type)

This parameter specifies how the acquisition is to be triggered. The choices are:

- IMMEDIATE (equivalent to Free Run); the acquisition is triggered immediately
- VIDEO; the acquisition is triggered when the IF envelope of the RF input reaches the level defined by the Input Trigger Level parameter
- INTERNAL; the acquisition is triggered from the test set's source
- EXTERNAL1; the acquisition is triggered from the TRIG IN 1 port at the front of the test set
- EXTERNAL2; the acquisition is triggered from the TRIG IN 2 port at the front of the test set

The key path for selecting the Input Trigger Type from the front panel menus is:

[Meas Setup], Acquisition Setup, Input Trigger Type

12: Input Trigger Level

This parameter specifies the power level (in dBm) at the RF input which is required to trigger the acquisition (provided that the Input Trigger Type parameter has been set to "VIDEO").

The key path for setting the Input Trigger Level from the front panel menus is:

[Meas Setup], Acquisition Setup, Input Trigger Level

13: Input Trigger Delay

This parameter specifies a time difference between the acquisition trigger (as configured by the two previous parameters) and the actual start of the acquisition.

Usually the delay is used to move the start of the acquisition to a point slightly after the trigger, to allow the signal time to settle before it is measured. However, if you want to ensure that a rising edge is captured, the delay can also be set to a negative value to create a "pre-trigger": if the parameter value is -10, the acquisition start is moved to a point 10 ms before the trigger, and data received 10 ms before the trigger can be included in the measurement results calculation. See [Appendix Figure 2-1, "Trigger Delay,"](#) for illustrations of positive and negative delays.

NOTE Although different time units can be used in setting the acquisition duration from the front panel, the parameter value as entered in the sequence is always in ms.

NOTE Also: if the value of this parameter is not zero, the acquisition start does not coincide with the trigger. This needs to be considered when setting the Analysis Offset parameter, which references the actual start of the acquisition, not the trigger.

The key path for setting the Input Trigger Delay from the front panel menus is:

[Meas Setup], Acquisition Setup, Input Trigger Delay

Figure 2-1 Trigger Delay

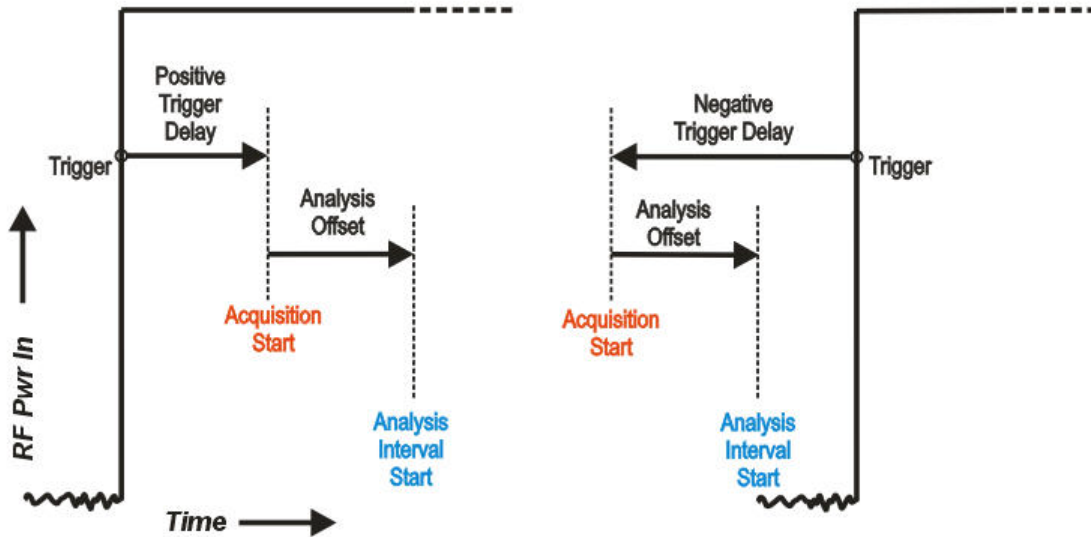

14: Output Trigger

This parameter specifies how the test set's analyzer generates a trigger at the start of an acquisition. The choices are:

- NONE; no output trigger is generated
- INTernal; the output trigger is routed to the test set source

If there is a need to furnish a trigger to the source at the outset of the sequence, before making any measurements, this can be accomplished by inserting a "dummy step" acquisition (with no analysis intervals) ahead of the first actual acquisition. This ensures that the source is triggered before the analyzer begins capturing data.

The key path for selecting the Output Trigger from the front panel menus is:

[Meas Setup], Acquisition Setup, Output Trigger

15: Instrument Gain LOW Value (dB)

NOTE This sequence parameter is used by some Keysight models for which Auto Set RF Levels can be on or off. For E6650A, Auto Set RF Levels is always on, and the test set automatically selects the this setting for the acquisition, so the value of this parameter is ignored by the sequencer.

16: Multiport Adapter Input Port

This optional parameter specifies which RFIO port of the connected Multiport Adapter will be used as the input path.

NOTE This sequence parameter is used by some Keysight models which are designed to operate in connection with a Multiport Adapter. For E6650A, which does not currently support that kind of operation, the value of this parameter is ignored by the sequencer.

17: Multiport Adapter Preamp

NOTE This sequence parameter is used by some Keysight models which are designed to operate in connection with a Multiport Adapter. For E6650A, which does not currently support that kind of operation, the value of this parameter is ignored by the sequencer.

18: Acquisition Integration

This optional parameter is used to extend the frequency span and dynamic range capabilities of the sequence analyzer. There is an IF bandwidth limitation of 40 MHz per acquisition, but it is possible to divide a measurement across multiple acquisitions in order to capture a larger total bandwidth. The Acquisition Integration parameter specifies how a given acquisition is to be integrated into a set of acquisitions.

Measurements which support integration of acquisitions for the purpose of frequency span extension are: SEM, ACP, and OBW.

Measurements which support integration of acquisitions for the purpose of dynamic range extension are: TD-SCDMA PvT and LTE-TDD PvT.

In Switched MIMO measurements, acquisitions are integrated for the purpose of combining additional measurements, made on separate input ports, with the primary acquisition.

Other kinds of measurements are performed only on a Normal or Primary acquisition type.

The possible settings are:

- **NORMAL**: this acquisition is complete in itself; it is not integrated with other acquisitions.
- **PRIMARY**: this acquisition is integrated with acquisitions which follow it, for purposes of extending its frequency span or dynamic range. (Results are stored in this acquisition, not in the Upper, Lower, or Range acquisitions with which it is integrated.)
- **LOWER**: this acquisition is integrated with the last Primary acquisition which precedes it in the sequence, in order to add a lower extension to the frequency span of the primary. Parameter settings for this acquisition match those of the primary, except that the Input Trigger is set to Free Run, and the Center Frequency is equal to the Center Frequency of the Primary minus the IF Bandwidth of the Primary.

Analyzer List Sequencer Parameter Definitions

Acquisition Parameters

- **UPPER**: This acquisition is integrated with the last Primary acquisition which precedes it in the sequence, in order to add an upper extension to the frequency span of the primary. Parameter settings for this acquisition match those of the primary, except that the Input Trigger is set to Free Run, and the Center Frequency is equal to the Center Frequency of the Primary plus the IF Bandwidth of the Primary.
- **RANGE**: this acquisition is integrated with the last Primary acquisition which precedes it in the sequence, in order to add a lower extension to the dynamic range of the primary. Parameter settings for this acquisition match those of the primary, except that Input Trigger is Free Run, Peak Power is -40 dBm, and Expected Power is -70 dBm.
- **SMIMO**: this acquisition is integrated with the last Primary acquisition which precedes it in the sequence, in order to combine measurement data from two ports (2x2 switched MIMO) or three ports (3X3 switched MIMO). Use "PRIMary" in the acquisition for the first port, "SMIMO" in the acquisition for the second port, and "SMIMO" for the acquisition in the third port if there is one.

The key path for setting Acquisition Integration from the front panel menus is:

[Meas Setup], Acquisition Setup, Acquisition Integration

19: Acquisition RF Input Port

This parameter determines the RF input port for the acquisition, and therefore the amplitude correction table which will be applied to the results. The possible settings are:

- RFIO 1
- RFIO 2
- RF Input. This means either RF3 I/O or RF4 I/O, depending on which was chosen under the **Input/Output > RF Output & Test Set Config > Half Duplex Config > RF Input** menu. To make that setting configurable, you must also select **List** rather than **Fixed** on the **Meas Setup > RF Input Port Mode** menu.

The key path for setting Acquisition RF Input Port from the front panel menus is:

[Meas Setup], Acquisition Setup, Acquisition RF Input Port

Analysis Interval Parameters

Each acquisition can include a number of analysis intervals. The intervals are time segments within an acquisition, during which a specific set of measurements is made. An acquisition can include as many analysis intervals as necessary, and the intervals can overlap in time (see [Figure 1-7 on page 17](#)).

Unlike the first 16 parameters of the sequence, which must remain unchanged during an acquisition, the last 5 parameters (described below) can be changed as many times as necessary during the same acquisition (however, any change does require a new analysis interval).

1: Analysis Number

The analysis intervals within an acquisition are numbered (1 through n); this parameter identifies the analysis interval by number.

This parameter has no purpose beyond identification of a particular analysis interval. The numerical order of the analysis intervals does not affect measurement timing (for example, the second interval can start before the first, or after it, or at the same time).

2: Analysis Offset

This parameter sets the delay between the start of the acquisition and the start of the analysis interval.

The actual start of the acquisition is not necessarily coincident with the trigger, unless Input Trigger Delay (the 13th parameter) is set to zero. Therefore, the trigger delay must be taken into account when choosing a value for Analysis Offset.

NOTE Although different time units can be used in setting the analysis offset from the front panel, the parameter value as entered in the sequence is always in ms.

The key path for setting the Analysis Offset from the front panel menus is:
[Meas Setup], Acquisition Setup, Analysis Step Setup, Analysis Offset

3: Analysis Interval

This parameter sets the length of the analysis interval (that is, the time period during which measurements are made on the acquired data). Measuring from the start of the acquisition, the analysis interval begins after the delay specified by the Analysis Offset parameter, and ends after the length specified by the Analysis Interval parameter.

NOTE Although different time units can be used in setting the analysis interval from the front panel, the parameter value as entered in the sequence is always in ms.

The key path for setting the Analysis Interval from the front panel menus is:
[Meas Setup], Acquisition Setup, Analysis Step Setup, Analysis Interval

4: Measurement Bitmap

This parameter is a decimal integer, for which the equivalent binary number specifies the set of measurements to be made during the analysis interval. Each bit in the equivalent binary number represents one of the available measurements. The selection of a radio standard for the acquisition determines which measurements are available and which are not, as defined in the table on the following page (a few measurements which aren't available in the EXF test set are included in the table for the sake of keeping the overall bitmap structure clear).

The way to determine the appropriate value for the parameter is to select from the available measurements, and add up their decimal weights (as shown in the rightmost column). For example, to choose the Occupied BW test (decimal weight 1024) and the Tx Power test (decimal weight 1), set the parameter value to 1025. This is binary 1000000001, and it selects only those two tests. (This would not be a possible value in the GSM/EDGE radio standard, which does not support the Occupied BW test.)

The key path for selecting the Measurement Bitmap from the front panel menus is:

[Meas Setup], Acquisition Setup, Analysis Step Setup, Measurement Bitmap

NOTE

The Basic IQ Data measurement (bitmap value "8") is incompatible with averaging. If the Average Count parameter for the acquisition is set to a value greater than 1, the analysis intervals within that acquisition cannot include Basic IQ Data in the Measurement Bitmap.

Available Measurements	Radio Standards							Bitmap Values	
	GSM	EDGE	W-CDMA	LTE-FDD	LTE-TDD	TD-SCDMA	WLAN	Bit	Decimal Weight
Basic TX Power	Y	Y	Y	Y	Y	Y	Y	0	1
Basic Freq & Phase	Y	Y	Y	Y	Y	Y	Y	1	2
Discrete PAVT	Y	Y	Y	Y	Y	Y	Y	2	4
Basic IQ Data	Y	Y	Y	Y	Y	Y	Y	3	8
PvT	Y	Y			Y	Y		4	16
ORFS	Y	Y						5	32
GMSK Ph & Freq	Y	Y						6	64
EDGE EVM	Y	Y						7	128
ACP			Y	Y	Y	Y		8	256
SEM			Y	Y	Y	Y	Y	9	512
Occupied BW			Y	Y	Y	Y	Y	10	1024
Mod Accuracy			Y	Y	Y	Y	Y	11	2048
QPSK EVM			Y			Y		12	4096
Code Domain			Y			Y		13	8192
Phase Discontinuity			Y					14	16384
Loopback BER	Y	Y	Y			Y		15	32768
EDR In-band Spurious Emission								16	65536
LE In-band Emission								17	131072
MIMO EVM							Y	18	262144

Measurements may differ as to which portion of the acquisition data they need to include. The Measurement Bitmap for each analysis interval should only include those measurements that use the same subset of data. To make a measurement which requires different data, add another analysis interval (with the Analysis Offset and Analysis Interval parameters set appropriately, and the measurement included in the Measurement Bitmap value).

5: Expected Power at DUT Output

This parameter specifies the expected power level from the DUT output, in dBm, for this analysis interval. The value entered here is used by the Basic Transmit Power measurement to verify that the received power is nominally the same as the value specified in this parameter (upper and lower limits for DUT output power can be specified as part of the Basic Transmit Power setup).

The lowest value set for this parameter, among the analysis intervals within the acquisition, is also used by the Auto Set RF Levels algorithm to determine the lower limit of the dynamic range for this acquisition.

NOTE For E6650A, Auto Set RF Levels is always on.

The key path for setting the Expected Power from the front panel menus is:
[Meas Setup], Acquisition Setup, Analysis Step Setup, Expected Power at DUT Output

NOTE If there is any doubt about what power levels are present at the input to the test set, measure the power with a power meter and set the attenuation appropriately. Failure to do so risks damaging the RF circuitry at the test set input.

3 Source List Sequencer Parameter Definitions

This chapter describes the parameters that are used in the setup of the source list sequencer. (The source and analyzer list sequencers can exchange triggers, but are otherwise configured independently.)

The chapter topics are:

- **Source Sequence**
- **Source Parameters**

Source Sequence

A source sequence consists of a series of steps, during each of which an RF waveform is generated by the test set's source.

The steps in a source sequence make it possible to generate a succession of RF waveforms, at a variety of frequencies and power levels, either independently of the analyzer or in coordination with the data acquisitions which are controlled by the analyzer list sequencer.

The source can generate an output to the device under test at the same time that the analyzer is receiving data from it; this makes it possible to test a mobile device in simultaneous transmit and receive mode.

Source Parameters

The parameters in the source sequence define the characteristics of the RF waveform to be generated, and also control the timing and triggering of the sequence steps.

The settings defined by these parameters cannot change during the sequence step. To modify any of these settings (for example, to change the frequency of the generated waveform), it is necessary to start a new sequence step.

The 11 parameters which cannot change during a sequence step are described below.

1: Step Number

Source steps are numbered sequentially (1 through n), and executed sequentially. One source step must end before the next step begins.

2: Step Trigger

This parameter specifies how the source step is to be triggered. The choices are:

- IMMEDIATE (equivalent to Free Run); the source begins generating a waveform without waiting for a trigger.
- KEY; the sequence is halted until the user presses the manual trigger key on the front panel. A popup window is displayed to indicate that the test set is waiting for the trigger input. (Sending the Bus Trigger SCPI command while the test set is waiting for a manual trigger had no effect.)
- BUS; the sequence is halted until the Bus Trigger SCPI command is sent (see the note below). A popup window is displayed to indicate that the test set is waiting for the trigger input. (Pressing the manual trigger key while the test set is waiting for the Bus Trigger SCPI command will have no effect.)
- INTERNAL; the source step is triggered from the test set's analyzer.
- EXTERNAL2; the source step is triggered from the TRIG IN 2 port on the rear panel of the test set.

NOTE The Bus Trigger SCPI command is in the form:
 :SOURce:LIST:TRIGger:INITiate[:IMMEDIATE]

The key path for selecting the Step Trigger from the front panel menus is:
[Source], List Sequencer, List Sequencer Setup, Step Trigger

3: Transition Time (also known as Setup Time)

This parameter specifies the time required within a given step to allow the source to settle at the specified frequency and amplitude settings. Recommended settings are as follows:

- Frequency change: 0.5 ms
- Amplitude change to within 1.0 dB: 0.1 ms
- Amplitude change to within 0.1 dB: 0.02 ms

NOTE Although different time units can be used in setting the transition time from the front panel, the parameter value as entered in the sequence is always in ms.

The key path for selecting Setup Time from the front panel menus is:
[Source], List Sequencer, List Sequencer Setup, Transition Time

4: Radio Band

This parameter specifies a radio band to be used. The choices are outlined below (listed beside the radio standards to which they apply).

Table 3-1 Values for Radio Band Parameter

Radio Standard	Radio Band
NONE	NONE
GSM or: EDGE	PGSM, EGSM, RGSM, DCS1800, PCS1900, GSM450, GSM480, GSM850, GSM700, T GSM810
WCDMA	BANDI, BANDII, BANDIII, BANDIV, BANDV, BANDVI, BANDVII, BANDVIII, BANDIX, BANDIX, BANDX, BANDXI, BANDXII, BANDXIII, BANDXIV, BANDXIX
LTE (LTE-FDD)	NONE, BAND1, BAND2, BAND3, BAND4, BAND5, BAND6, BAND7, BAND8, BAND9, BAND10, BAND11, BAND12, BAND13, BAND14, BAND17, BAND18, BAND19, BAND20, BAND21, BAND24, BAND25, BAND26, BAND27, BAND28, BAND31
LTE-TDD	BAND33, BAND34, BAND35, BAND36, BAND37, BAND38, BAND39, BAND40, BAND41, BAND42, BAND43, BAND44
TD-SCDMA	BANDA, BANDB, BANDC, BANDD, BANDE, BANDF

The key path for selecting Radio Band from the front panel menus is:
[Source], List Sequencer, List Sequencer Setup, Radio Setup, Radio Standard, <select band>

5: Radio Band Link

This parameter specifies the link direction for the present step within the source sequence. The link direction is used in conjunction with the Radio Band and Channel parameters to determine the output frequency. When set to “UP”, the source will calculate the uplink frequency according to an uplink formula together with selected radio band and channel number. When set to “DOWN”, the source will calculate the downlink frequency according to a downlink formula together with selected channel band and channel number.

The key path for selecting Radio Band Link from the front panel menus is:
[Source], List Sequencer, List Sequencer Setup, Radio Setup, Link

6: Frequency/Channel

This parameter specifies the frequency to be generated, either directly (in MHz) or by channel number. If the radio band specified by the previous parameter is NONE, the present parameter represents the frequency in MHz; otherwise, the present parameter represents the channel number.

The key path for setting Frequency or Channel from the front panel menus is:

[Source], List Sequencer, List Sequencer Setup, Frequency / Channel

7: Power

This parameter defines the output power level to be generated, in dBm.

The key path for selecting Power from the front panel menus is:

[Source], List Sequencer, List Sequencer Setup, Power

8: Waveform

This parameter specifies the waveform to be generated. The choices are:

- <Waveform>: the name of a waveform file currently in ARB memory. The supported file types are .wfm, .bin, and .WAVEFORM.
- CONT: Continue Previous (that is, continue playback of the waveform from the previous step in the sequence).
- CW: Continuous wave (that is, generate an unmodulated tone).
- OFF: Disables RF output of the test set.

NOTE If this parameter is set to CONT, the ARB playback will not pause while the source is retuning to a new frequency or power level which the step may require.

The key path for selecting the Waveform from the front panel menus is:

[Source], List Sequencer, List Sequencer Setup, Waveform

9: Step Duration

This parameter, in combination with the following parameter (Time/Count), determines the duration of the step. The choices are:

- TIME: the duration of the step is specified in absolute terms; if this choice is selected, the value of the Time/Count parameter is interpreted as a duration in ms.
- COUNT: the duration of the step is specified as the number of times the waveform file in ARB memory is played; if this choice is selected, the value of the Time/Count parameter is interpreted as a waveform playback count. This choice is applicable only if a waveform file is being played; it cannot be selected if the step has been set up (by the Waveform parameter) to play a CW tone.
- CONTinuous: if this choice is selected, the step will play continuously until the next step starts.

Source List Sequencer Parameter Definitions

Source Parameters

The key path for selecting the Step Duration from the front panel menus is:

[Source], List Sequencer, List Sequencer Setup, Step Duration

10: Time / Count

This parameter specifies the duration of the step in ms (if the Step Duration parameter has been set to "TIME"), or as the number of times a waveform file is played (if the Step Duration parameter has been set to "COUNT"). If the Step Duration parameter has been set to "CONTinuous", this parameter is ignored.

The key path for selecting the Duration from the front panel menus is:

[Source], List Sequencer, List Sequencer Setup, Step Duration, Time/Count

11: Output Trigger

This parameter specifies the type of trigger output signal which will be sent at the start of the step. The choices are:

- ON: the trigger output is sent to the test set's analyzer (for triggering of the analyzer list sequencer), and also to the TRIGGER 2 OUT port at the rear panel of the test set.
- OFF; no trigger output is generated by the source.

The key path for selecting Output Trigger from the front panel menus is:

[Source], List Sequencer, List Sequencer Setup, Output Trigger

4 Coordinating the Sequencers

The independence of the list sequencers provides great flexibility, but it also requires careful coordination of the two, when both are used at once. It is important to manage the order of events, so that one list sequencer does not proceed before the other is ready.

It is not possible for both sequencers to be initiated absolutely simultaneously. When both are used, the source list sequencer should always be initiated first. There are two ways to coordinate the sequencers so that they are initiated in the proper order:

- Enable **Meas Setup, Include Source in Sequence**. When this selection is made, both of the list sequencers are initiated automatically, in the correct order, when you use a command or key to initiate the analyzer sequence (in this case, the source sequence cannot be initiated independently of the analyzer sequence).
- If “Include Source in Sequence” is disabled, then the source and analyzer must be initiated independently, and the source must be initiated first. This sometimes requires the addition of a “dummy step” in a sequence, to ensure that the source does not begin playing before the analyzer is ready to capture data.

This chapter explains how to initiate and trigger the sequencers (when both sequencers are used at the same time), for alternative test cases.

The chapter topics are:

- **Include Source in Sequence is enabled**
- **Include Source in Sequence is disabled**

Include Source in Sequence is enabled

When **Meas Setup, Include Source in Sequence** is enabled, the source cannot be initiated independently. It is initiated automatically, as described below.

Case 1: Test starts when RF is received by the test set

NOTE Whenever “Include Source in Sequence” is enabled, it is recommended to set the analyzer list sequencer to **Single** mode, by pressing the **Single** key or by sending the `:INIT:CONT OFF` command, to avoid timing problems which could occur in **Continuous** mode.

- Step 1.** Set the Step Trigger parameter of the first step in the source sequence to **INTernal** (the input trigger will come from the analyzer list sequencer).
- Step 2.** Set the Input Trigger parameter of the first acquisition in the analyzer sequence to **VIDeo** (an RF burst, to be received from the DUT, triggers the analyzer list sequencer).
- Step 3.** Set the Output Trigger parameter of the first acquisition in the analyzer sequence to **INTernal** (the output trigger will be provided to the source list sequencer).
- Step 4.** Initiate the analyzer list sequencer, using the **Restart** key, or by sending the `:INIT` command. This initiates the source list sequencer, and arms it to begin running as soon as it receives the input trigger. Then the analyzer list sequencer is initiated, and armed to begin running as soon as it is triggered by the DUT’s RF burst. The sequence is executed one time.

Once the sequencers are initiated, the order of events is as follows:

- The controller begins the non-signaling test by instructing the DUT to transmit an RF signal.
- The analyzer list sequencer, triggered by the RF Burst received from the DUT, sends a trigger to the source list sequencer.
- The source list sequencer begins executing its sequence and generating an RF output to the DUT.

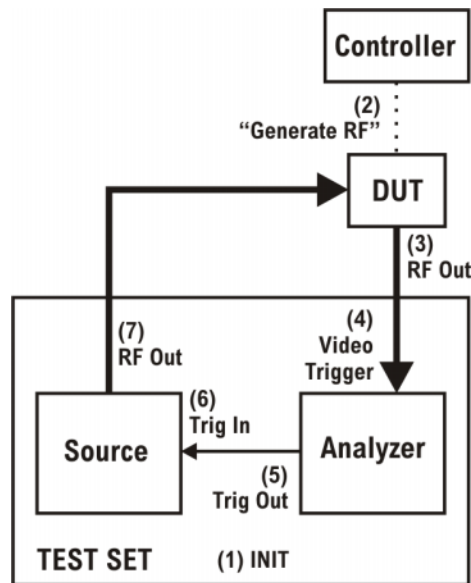

Case 1A: Test starts when RF is transmitted from the test set

NOTE Whenever “Include Source in Sequence” is enabled, it is recommended to set the analyzer list sequencer to Single mode, by pressing the **Single** key or by sending the `:INIT:CONT OFF` command, to avoid timing problems which could occur in Continuous mode.

- Step 1.** Set the Step Trigger parameter of the first step in the source sequence to IMMEDIATE (a Free Run trigger setting).
- Step 2.** Set the Output Trigger of the first acquisition to NONE. Set the Input Trigger of the acquisition to VIDEO, and it will be triggered by the RF burst from the DUT.
- Step 3.** Initiate the analyzer list sequencer, using the **Restart** key, or by sending the `:INIT` command. To begin with, this initiates the source list sequencer. Then the analyzer list sequencer is initiated, and armed to begin running as soon as it is triggered by the DUT’s RF burst. The sequence is executed one time.

Once the analyzer list sequencer is initiated, the order of events is as follows:

- The source list sequencer begins executing its sequence and generating an RF output to the DUT.
- The analyzer list sequence begins executing its sequence, and measuring the RF input from the DUT.

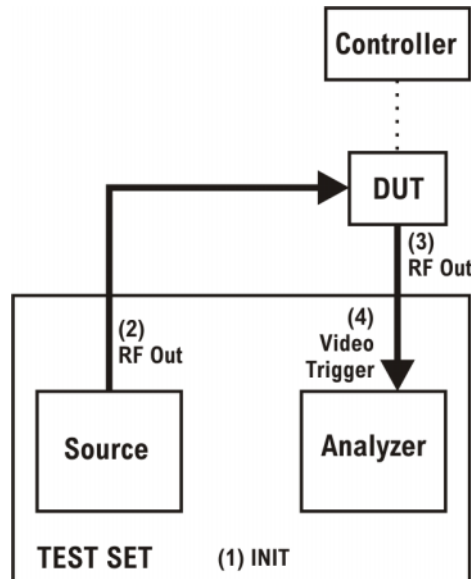

Include Source in Sequence is disabled

When **Meas Setup, Include Source in Sequence** is disabled, the source list sequencer and the analyzer list sequencer must be initiated separately, as described below.

Case 2: Test starts when RF is received by the test set

- Step 1.** Set the Trigger parameter of the first step in the source sequence to **INTernal** (the trigger will come from the analyzer list sequencer).
- Step 2.** Set the Input Trigger parameter of the first acquisition in the analyzer sequence to **VIDeo** (the trigger will be an RF burst, to be received from the DUT).
- Step 3.** Set the Output Trigger parameter of the first acquisition in the analyzer sequence to **INTernal** (the output trigger will be provided to the source list sequencer).
- Step 4.** Set the analyzer list sequencer to Single mode, by pressing the **Single** key or by sending the `:INIT:CONT OFF` command.
- Step 5.** Initiate the source list sequencer, using the **Source, List Sequencer, Initiate Sequence** key, or by sending the `:SOURCE:LIST:TRIG` command. This arms the source list sequencer to begin running as soon as it receives the input trigger from the analyzer list sequencer.
- Step 6.** Initiate the analyzer list sequencer, using the **Restart** key, or by sending the `:INIT` command. This causes the analyzer list sequencer to execute the sequence one time.

Once the analyzer list sequencer is initiated, the order of events is as follows:

- The controller begins the non-signalling test by instructing the DUT to transmit an RF signal.
- The analyzer list sequencer, triggered by the RF Burst received from the DUT, sends a trigger to the source list sequencer.
- The source list sequencer begins executing its sequence and generating an RF output to the DUT.

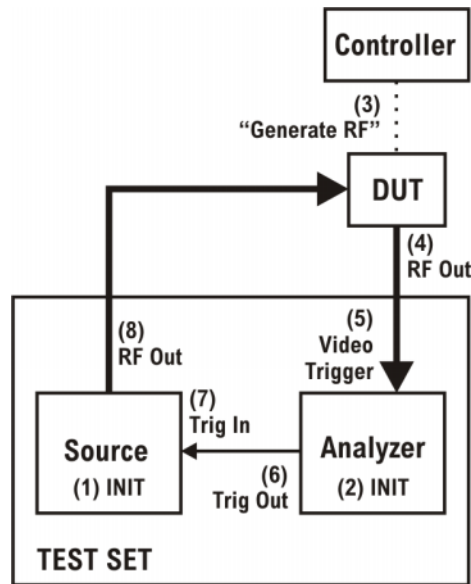

Case 2A: Test starts when RF is transmitted from the test set

NOTE This sequence includes an acquisition which has no analysis intervals, and exists only to generate an output trigger to the source. It is used as a “dummy step”, to ensure that the source does not begin playing before the analyzer is ready to capture data. The need for a dummy step arises in this case because (1) the source is to begin playing at the outset of the test, and (2) “Include Source in Sequence” is not enabled, therefore there is a delay between initiation of the source and initiation of the analyzer. (Enabling “Include Source in Sequence” eliminates the need for a dummy step of this kind.)

- Step 1.** Set the Step Trigger parameter of the first step in the source sequence to INTernal (the trigger will come from the analyzer list sequencer).
- Step 2.** Insert a “dummy step” acquisition (with no analysis intervals) ahead of the first acquisition in the analyzer sequence. As this acquisition is only used to generate a starting trigger for the source, and makes no measurement, the Acquisition Duration parameter setting can have a low value (10 us, for example).
- Step 3.** For the “dummy step” acquisition, set the Input Trigger parameter to IMMEDIATE, and set the Output Trigger parameter to INTernal (the output trigger will be provided to the source list sequencer).
- Step 4.** For the next acquisition, which includes analysis intervals, set the Input Trigger parameter to VIDEO, and set the Output Trigger parameter to INTernal (the analyzer list sequencer will be triggered by an RF burst from the DUT, and the output trigger will be provided to the source list sequencer).
- Step 5.** Set the analyzer list sequencer to Single mode, by pressing the **Single** key or by sending the :INIT:CONT OFF command.
- Step 6.** Initiate the source list sequencer, using the **Source, List Sequencer, Initiate Sequence** key, or by sending the :SOURCE:LIST:TRIG command. This arms the source list sequencer to begin running.
- Step 7.** Initiate the analyzer list sequencer, using the **Restart** key, or by sending the :INIT command. The analyzer list sequencer is initiated, and armed to begin running as soon as it is triggered by the DUT’s RF burst. The sequence is executed one time.

Once the analyzer list sequencer is initiated, the order of events is as follows:

- The “dummy step” acquisition causes the analyzer list sequencer to trigger the source list sequencer.
- The source list sequencer begins executing its sequence and generating an RF output to the DUT.
- The first “real” acquisition (containing analysis steps) is triggered by the RF input from the DUT.

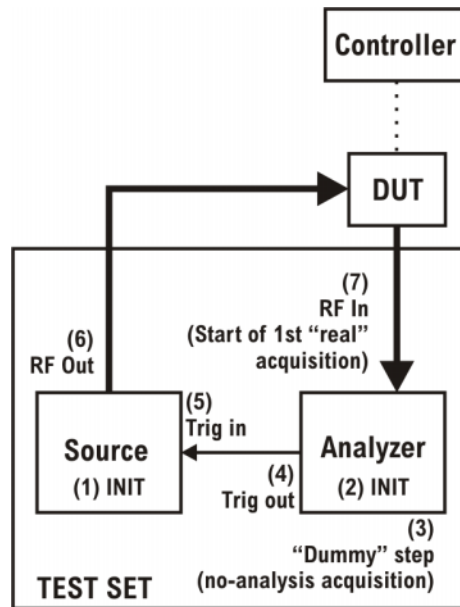

Coordinating the Sequencers
Include Source in Sequence is disabled

5 Mode Parameters

This chapter identifies the test set parameters that are set for the entire Sequence.

The chapter topics are:

- **Mode and Measurement Parameters**
- **List Sequencer Global Parameters**
- **Advanced Setup Parameters**
- **Test Set Parameters**
 - RF inputs and outputs
 - Corrections
- **Save and Recall**

Mode and Measurement Parameters

It is possible, in Sequence Analyzer mode, to run certain measurements which belong to other modes (such as the EDGE/EVM mode). For example, the EDGE EVM measurement, which is one of the measurements featured in the GSM/EDGE mode, can also be run in Sequence Analyzer mode.

NOTE Settings for a measurement, or for the mode it belongs to, are not changed by entering or exiting Sequence Analyzer mode. When you set a parameter for a measurement or mode, the parameter retains that value until you make another specific change to it, regardless of whether the test set is placed in Sequence Analyzer mode or in the native mode of the measurement. (Returning to a previous mode does not restore previous settings.)

The present chapter describes parameters that apply to a measurement mode and all of its measurements, and can be changed from within the Sequence Analyzer mode (by remote command only).

For information on parameters that pertain to a specific measurement within a measurement mode, and can be changed from within the Sequence Analyzer mode, see the following chapters:

- [Chapter 13, “GSM/EDGE Programming Commands”, on page 187](#)
- [Chapter 14, “W-CDMA Programming Commands”, on page 207](#)
- [Chapter 15, “LTE-FDD Programming Commands”, on page 231](#)
- [Chapter 16, “LTE-TDD Programming Commands”, on page 253](#)
- [Chapter 17, “TD-SCDMA Programming Commands”, on page 279](#)
- [Chapter 18, “WLAN Programming Commands”, on page 301](#)

The commands used here to set measurement mode parameters (from within the Sequence Analyzer mode) are almost the same as the commands which would be used outside the Sequence Analyzer mode; the only difference is the addition of `LSEQuencer:<modename>` nodes to each command.

For example, `[:SENSe] :RADio:PSHape WIDE` becomes `[:SENSe] :LSEQuencer:EDGE:RADio:PSHape WIDE`.

NOTE “EDGE” (and not “GSM”) is used to designate the GSM/EDGE mode in commands.

As explained above, a parameter change which is made in this way remains in effect even after the test set is no longer in Sequence Analyzer mode. Selecting GSM/EDGE mode would not undo a GSM/EDGE setting change that was made in Sequence Analyzer mode.

The settings apply for the whole Sequence (not just for a particular acquisition), and should be set up prior to starting the Sequence.

GSM Timeslot

Time Slot setting for GSM mode. Provides an On/Off for each timeslot (0 to 7). Generally used only with periodic and ext frame triggers. For more details about the command see the GSM/EDGE online help (or in pdf format, the User's and Programmer's Reference).

```
[ :SENSe] :LSEQuencer:EDGE:CHANnel:SLOT <integer>
```

```
[ :SENSe] :LSEQuencer:EDGE:CHANnel:SLOT?
```

```
[ :SENSe] :LSEQuencer:EDGE:CHANnel:SLOT:AUTO OFF|ON|0|1
```

```
[ :SENSe] :LSEQuencer:EDGE:CHANnel:SLOT:AUTO?
```

GSM Burst Type

Burst Type setting for GSM mode. Specifies the burst type that the test set searches for, and to which it synchronizes. For more details about the command see the GSM/EDGE online help (or in pdf format, the User's and Programmer's Reference).

Choices:

- Sync (SCH)
- Access (RACH)
- Normal - NB (TCH and CCH)
- Higher Symbol Rate - HB (TCH and CCH); requires EDGE Evolution U9071A-3FP to be installed
- Mixed (NB/HB for TSC sync); requires EDGE Evolution U9071A-3FP to be installed

```
[ :SENSe] :LSEQuencer:EDGE:CHANnel:BURSt NORMAlSYNC|ACCess|HSRate|MIXed
```

```
[ :SENSe] :LSEQuencer:EDGE:CHANnel:BURSt?
```

GSM TSC

TSC setting for GSM mode. Allows you to select the Training Sequence Code that determines which burst is to be measured. Applicable only when the selected GSM measurement requires a burst sync of type "Training Sequence". For more details about the command see the GSM/EDGE online help (or in pdf format, the User's and Programmer's Reference).

```
[ :SENSe] :LSEQuencer:EDGE:CHANnel:TSCode <integer>
```

```
[ :SENSe] :LSEQuencer:EDGE:CHANnel:TSCode?
```

Mode Parameters

Mode and Measurement Parameters

GSM Mod Scheme

Modulation scheme setting for GSM mode. Selects the Modulation Scheme (modulation type) for Normal Burst that the test set searches for when Auto mode is selected. For more details about the command see the GSM/EDGE online help (or in pdf format, the User's and Programmer's Reference).

```
[ :SENSE ] :LSEQuencer:EDGE:SYNC:NORMal:MODulation:AUTO ON|OFF|1|0
```

```
[ :SENSE ] :LSEQuencer:EDGE:SYNC:NORMal:MODulation:AUTO?
```

GSM Burst Search Threshold

Burst Search Threshold setting for GSM mode. Sets the relative power threshold from the peak power, which is used by the burst alignment algorithm to determine the burst rising edge and falling edge. For more details about the command see the GSM/EDGE online help (or in pdf format, the User's and Programmer's Reference).

```
[ :SENSE ] :LSEQuencer:EDGE:SYNC:BURSt:STHreshold <rel_ampl>
```

```
[ :SENSE ] :LSEQuencer:EDGE:SYNC:BURSt:STHreshold?
```

GSM HSR Pulse Shape Filter

HSR Pulse Shaping Filter setting for GSM mode. Selects the pulse shaping filter for higher symbol rate (HSR) signals. For more details about the command see the GSM/EDGE online help (or in pdf format, the User's and Programmer's Reference).

This functionality applies only to the following measurements:

- EDGE EVM Measurement
- EDGE Power vs. Time Measurement
- GMSK/EDGE Output RF Spectrum measurement

Requires EDGE Evolution U9071A-3FP to be installed.

```
[ :SENSE ] :LSEQuencer:EDGE:RADio:PSHape NARRow|WIDE
```

```
[ :SENSE ] :LSEQuencer:EDGE:RADio:PSHape?
```

GSM Burst Align

Burst Align setting for GSM mode. Selects the sync alignment to be either to the GSM standard or the standard offset by a half bit behind. For more details about the command see the GSM/EDGE online help (or in pdf format, the User's and Programmer's Reference).

```
[ :SENSE ] :LSEQuencer:EDGE:SYNC:ALIGnment GSM|HBIT
```

```
[ :SENSE ] :LSEQuencer:EDGE:SYNC:ALIGnment?
```

GSM Carrier Bandpass Filter

Carrier Bandpass Filter setting for GSM mode. Select Multiple or Single to enable or disable the multi-carrier tolerance filter. For more details about the command see the GSM/EDGE online help (or in pdf format, the User's and Programmer's Reference).

```
[ :SENSe] :LSEQuencer:EDGE:RADio:CARRier:NUMBer SINGLE|MULTiple  
[ :SENSe] :LSEQuencer:EDGE:RADio:CARRier:NUMBer?
```

GSM RF Sync Delay

RF Sync Delay setting for GSM mode. Adjusts the "T0" point that has been measured in each measurement. This adjustment does not apply if the Burst Sync key (in each measurement's Meas Setup menu) is set to None. For more details about the command see the GSM/EDGE online help (or in pdf format, the User's and Programmer's Reference).

```
[ :SENSe] :LSEQuencer:EDGE:SYNC:BURSt:RFAMplitude:DELay <time>  
[ :SENSe] :LSEQuencer:EDGE:SYNC:BURSt:RFAMplitude:DELay?
```

TD-SCDMA Analysis Timeslot

Analysis timeslot setting for TD-SCDMA mode. It specifies which sub-frames timeslot, within the selected Sub-frame, is used for analysis and trace data measurement results. The available selections include timeslots 0 through 6, the DwPTS and UpPTS timeslots. For more details about the command see the TD-SCDMA online help (or in pdf format, the User's and Programmer's Reference).

```
[ :SENSe] :LSEQuencer:TDSCdma:SLOT TS0|TS1|TS2|TS3|TS4|TS5|TS6|UPTS|DPTS  
[ :SENSe] :LSEQuencer:TDSCdma:SLOT?
```

TD-SCDMA HSPA/8PSK Enable

HSPA/8PSK Enable setting for TD-SCDMA mode. (This feature requires installation of the HSPA/8PSK option license.) For more details about the command see the TD-SCDMA online help (or in pdf format, the User's and Programmer's Reference).

```
[ :SENSe] :LSEQuencer:TDSCdma:RADio:CONFIgure:HSDPa[:STATE] 0|1|OFF|ON  
[ :SENSe] :LSEQuencer:TDSCdma:RADio:CONFIgure:HSDPa[:STATE]??
```

TD-SCDMA Demod – Scramble Code

Scramble Code setting for TD-SCDMA mode. The available range is 0 ~ 127. For more details about the command see the TD-SCDMA online help (or in pdf format, the User's and Programmer's Reference).

```
[ :SENSe] :LSEQuencer:TDSCdma:TDEMod:SCODE <integer>  
[ :SENSe] :LSEQuencer:TDSCdma:TDEMod:SCODE?
```

Mode Parameters

Mode and Measurement Parameters

TD-SCDMA Demod – Uplink Pilot

Uplink Pilot setting for TD-SCDMA mode. It specifies the Uplink Pilot synchronization ID sequence (SYNC-UL). The available range is 0 ~ 255. For more details about the command see the TD-SCDMA online help (or in pdf format, the User's and Programmer's Reference).

```
[ :SENSe] :LSEQuencer:TDSCdma:TDEMod:UPTS <integer>
```

```
[ :SENSe] :LSEQuencer:TDSCdma:TDEMod:UPTS?
```

TD-SCDMA Demod – Sync Type

Sync Type setting for TD-SCDMA mode. The available selections include Pilot, Midamble and Trigger. Pilot synchronization searches for either the Uplink Pilot or Downlink Pilot burst and then uses the location of that burst to position all of the rest of the time slots. Synchronization will fail if neither pilot burst is found or if the incorrect Uplink or Downlink Pilot Code ID is set for the Pilot burst present. Midamble synchronization searches for the first Uplink traffic burst, positioning it as timeslot TS1. Synchronization will fail if there are Pilot bursts present, if TSO is present, if there are no traffic bursts present or if the incorrect Basic Midamble Code ID is set. Trigger synchronization deems the position of the trigger as the start of the frame of the TD-SCDMA signal. For more details about the command see the TD-SCDMA online help (or in pdf format, the User's and Programmer's Reference).

```
[ :SENSe] :LSEQuencer:TDSCdma:TDEMod:SYNC PILOt | MIDamble | TRIGGER
```

```
[ :SENSe] :LSEQuencer:TDSCdma:TDEMod:SYNC?
```

TD-SCDMA Demod – Switching Point

Switching Point setting for TD-SCDMA mode. Switching Point is the timeslot number of the last uplink traffic timeslot. Timeslots from the following (next higher numbered) traffic timeslot through the end of the sub-frame are treated as downlink timeslots. For more details about the command see the TD-SCDMA online help (or in pdf format, the User's and Programmer's Reference).

```
[ :SENSe] :LSEQuencer:TDSCdma:TDEMod:ULSPoint <integer>
```

```
[ :SENSe] :LSEQuencer:TDSCdma:TDEMod:ULSPoint?
```

TD-SCDMA Demod – Max Users for Traffic TS0

Max Users for Traffic TS0 setting for TD-SCDMA mode. It specifies the number of Maximum Users that will be associated with the timeslots 0. The range is 2 ~ 16. For more details about the command see the TD-SCDMA online help (or in pdf format, the User's and Programmer's Reference).

```
[ :SENSe] :LSEQuencer:TDSCdma:TDEMod:MXUser:TS0 <integer>
```

```
[ :SENSe] :LSEQuencer:TDSCdma:TDEMod:MXUser:TS0?
```

TD-SCDMA Demod – Max Users for Traffic TS1

Max Users for Traffic TS1 setting for TD-SCDMA mode. It specifies the number of Maximum Users that will be associated with the timeslots 1. The range is 2 ~ 16. For more details about the command see the TD-SCDMA online help (or in pdf format, the User's and Programmer's Reference).

```
[ :SENSe] :LSEQuencer:TDSCdma:TDEMod:MXUser:TS1 <integer>
```

```
[ :SENSe] :LSEQuencer:TDSCdma:TDEMod:MXUser:TS1?
```

TD-SCDMA Demod – Max Users for Traffic TS2

Max Users for Traffic TS2 setting for TD-SCDMA mode. It specifies the number of Maximum Users that will be associated with the timeslots 2. The range is 2 ~ 16. For more details about the command see the TD-SCDMA online help (or in pdf format, the User's and Programmer's Reference).

```
[ :SENSe] :LSEQuencer:TDSCdma:TDEMod:MXUser:TS2 <integer>
```

```
[ :SENSe] :LSEQuencer:TDSCdma:TDEMod:MXUser:TS2?
```

TD-SCDMA Demod – Max Users for Traffic TS3

Max Users for Traffic TS3 setting for TD-SCDMA mode. It specifies the number of Maximum Users that will be associated with the timeslots 3. The range is 2 ~ 16. For more details about the command see the TD-SCDMA online help (or in pdf format, the User's and Programmer's Reference).

```
[ :SENSe] :LSEQuencer:TDSCdma:TDEMod:MXUser:TS3 <integer>
```

```
[ :SENSe] :LSEQuencer:TDSCdma:TDEMod:MXUser:TS3?
```

TD-SCDMA Demod – Max Users for Traffic TS4

Max Users for Traffic TS4 setting for TD-SCDMA mode. It specifies the number of Maximum Users that will be associated with the timeslots 4. The range is 2 ~ 16. For more details about the command see the TD-SCDMA online help (or in pdf format, the User's and Programmer's Reference).

```
[ :SENSe] :LSEQuencer:TDSCdma:TDEMod:MXUser:TS4 <integer>
```

```
[ :SENSe] :LSEQuencer:TDSCdma:TDEMod:MXUser:TS4?
```

Mode Parameters

Mode and Measurement Parameters

TD-SCDMA Demod – Max Users for Traffic TS5

Max Users for Traffic TS5 setting for TD-SCDMA mode. It specifies the number of Maximum Users that will be associated with the timeslots 5. The range is 2 ~ 16. For more details about the command see the TD-SCDMA online help (or in pdf format, the User's and Programmer's Reference).

```
[ :SENSe] :LSEQuencer:TDSCdma:TDEMod:MXUSer:TS5 <integer>
```

```
[ :SENSe] :LSEQuencer:TDSCdma:TDEMod:MXUSer:TS5?
```

TD-SCDMA Demod – Max Users for Traffic TS6

Max Users for Traffic TS6 setting for TD-SCDMA mode. It specifies the number of Maximum Users that will be associated with the timeslots 6. The range is 2 ~ 16. For more details about the command see the TD-SCDMA online help (or in pdf format, the User's and Programmer's Reference).

```
[ :SENSe] :LSEQuencer:TDSCdma:TDEMod:MXUSer:TS6 <integer>
```

```
[ :SENSe] :LSEQuencer:TDSCdma:TDEMod:MXUSer:TS6?
```

TD-SCDMA Demod – Slot Frequency Reference

Slot Frequency Reference setting for TD-SCDMA mode. It specifies whether the appropriate pilot timeslot or the midamble section of the timeslot will be used as the frequency and phase reference for an individual traffic timeslot. For more details about the command see the TD-SCDMA online help (or in pdf format, the User's and Programmer's Reference).

```
[ :SENSe] :LSEQuencer:TDSCdma:TDEMod:SREFerence PILot|MIDamble
```

```
[ :SENSe] :LSEQuencer:TDSCdma:TDEMod:SREFerence?
```

TD-SCDMA Demod – Code Channel Detection

Code Channel Detection setting for TD-SCDMA mode. If the current timeslot is DwPTS or UpPTS, its value will be set to AUTO. For more details about the command see the TD-SCDMA online help (or in pdf format, the User's and Programmer's Reference).

```
[ :SENSe] :LSEQuencer:TDSCdma:TDEMod:CDCHannel:DETection AUTO|MAN
```

```
[ :SENSe] :LSEQuencer:TDSCdma:TDEMod:CDCHannel:DETection?
```

TD-SCDMA Demod – Mod Scheme

Modulation Scheme setting for TD-SCDMA mode. (This setting can be made only if the HSPA/8PSK option license is installed and Enable HSPA/8PSK is ON; otherwise the value is fixed at AUTO.) If the Mod Scheme is MAN, you must specify the modulation format for each channel. If the Mod Scheme is Auto, the measurement will automatically detect the channel's modulation format. If the current timeslot is DwPTS or UpPTS, its value will be set to AUTO. The Auto mode is only applied to QPSK, 8PSK and 16QAM. For 64QAM, only MAN mode is supported.

The Auto mode is only applied to QPSK, 8PSK and 16QAM. For 64QAM, it only supports MAN mode. For more details about the command see the TD-SCDMA online help (or in pdf format, the User's and Programmer's Reference).

```
[ :SENSe] :LSEQuencer:TDSCdma:TDEMod:MODScheme:AUTO 1|0|ON|OFF
```

```
[ :SENSe] :LSEQuencer:TDSCdma:TDEMod:MODScheme:AUTO?
```

TD-SCDMA Demod – Scramble Code

Scramble Code setting for TD-SCDMA mode. The available range is 0 ~ 127. For more details about the command see the TD-SCDMA online help (or in pdf format, the User's and Programmer's Reference).

```
[ :SENSe] :LSEQuencer:TDSCdma:TDEMod:SCODE <integer>
```

```
[ :SENSe] :LSEQuencer:TDSCdma:TDEMod:SCODE?
```

TDSCDMA Demod – Channel Configuration

The following set of commands allows you to specify the parameters for the channel. They are unavailable when “Code Channel Detection” and “Mod Scheme” are both AUTO.

- Select Code Length
- Select All Code Channels
- Select Code Channel
- Code Channel Status
- Midamble Shift
- Modulation Format
- Phase Shift
- Phase Shift Detection

TD-SCDMA Select Code Length

Select Code Length in Channel Configuration setting for TD-SCDMA mode. The available selections include 1, 2, 4, 8 and 16. For more details about the command see the TD-SCDMA online help (or in pdf format, the User’s and Programmer’s Reference).

```
[ :SENSe] :LSEQuencer:TDSCdma:TDEMod:SCLength <integer>
```

```
[ :SENSe] :LSEQuencer:TDSCdma:TDEMod:SCLength?
```

TD-SCDMA Select All Code Channels

Select All Code Channels in Channel Configuration setting for TD-SCDMA mode. If the Select All Code Channels is ON, by modifying the modulation format or the midamble shift, the user can change the values of all code channels which have the same code length and at the same time, the Select Code Channel key will be unavailable. For more details about the command see the TD-SCDMA online help (or in pdf format, the User’s and Programmer’s Reference).

```
[ :SENSe] :LSEQuencer:TDSCdma:TDEMod:CDCHannel:SALL 1|0|ON|OFF
```

```
[ :SENSe] :LSEQuencer:TDSCdma:TDEMod:CDCHannel:SALL?
```

TD-SCDMA Select Code Channel

Select Code Channel in Channel Configuration setting for TD-SCDMA mode. The max value for the code Channel should be (Select Code length – 1). The Dispread Channel Code Channel is used, along with the Dispread Channel Spread Code Length, to specify the active code channel and layer used for the channel trace data measurement results. This is unavailable if Select All Code Channel is ON. For more details about the command see the TD-SCDMA online help (or in pdf format, the User’s and Programmer’s Reference).

```
[ :SENSe] :LSEQuencer:TDSCdma:TDEMod:CDCHannel <integer>
```

```
[ :SENSe] :LSEQuencer:TDSCdma:TDEMod:CDCHannel?
```

TD-SCDMA Code Channel Status

Code Channel Status in Channel Configuration setting for TD-SCDMA mode. This is unavailable when “Code Channel Detection” is AUTO. For more details about the command see the TD-SCDMA online help (or in pdf format, the User’s and Programmer’s Reference).

```
[ :SENSE ] :LSEQuencer:TDSCdma:TDEMod:CDCHannel:ACTive
<spread_code_length>,<code_channel>,0|1|OFF|ON
```

```
[ :SENSE ] :LSEQuencer:TDSCdma:TDEMod:CDCHannel:ACTive?
<spread_code_length>,<code_channel>
```

TD-SCDMA Midamble Shift

Midamble Shift in Channel Configuration setting for TD-SCDMA mode. The range is 1 ~ 16. For more details about the command see the TD-SCDMA online help (or in pdf format, the User’s and Programmer’s Reference).

```
[ :SENSE ] :LSEQuencer:TDSCdma:TDEMod:MSHift
<spread_code_length>,<code_channel>,<integer>
```

```
[ :SENSE ] :LSEQuencer:TDSCdma:TDEMod:MSHift?
<spread_code_length>,<code_channel>
```

TD-SCDMA Modulation Format

Modulation Format in Channel Configuration setting for TD-SCDMA mode. If Auto is assigned to a code channel with some spread code length, the modulation format on this code channel will be determined by the measurement. For more details about the command see the TD-SCDMA online help (or in pdf format, the User’s and Programmer’s Reference).

```
[ :SENSE ] :LSEQuencer:TDSCdma:TDEMod:MODFormat
<integer>,<integer>,AUTO|QPSK|PSK8|QAM16|QAM64
```

```
[ :SENSE ] :LSEQuencer:TDSCdma:TDEMod:MODFormat? <integer>,<integer>
```

TD-SCDMA Phase Shift

Phase Shift in Channel Configuration setting for TD-SCDMA mode. The range is -360.0 ~ 360.0 degree. For more details about the command see the TD-SCDMA online help (or in pdf format, the User’s and Programmer’s Reference).

```
[ :SENSE ] :LSEQuencer:TDSCdma:TDEMod:PHASe:SHIFt <integer>,<integer>,<real>
```

```
[ :SENSE ] :LSEQuencer:TDSCdma:TDEMod:PHASe:SHIFt? <integer>,<integer>?
```

TD-SCDMA Phase Shift Detection

Phase Shift Detection in Channel Configuration setting for TD-SCDMA mode. For more details about the command see the TD-SCDMA online help (or in pdf format, the User’s and Programmer’s Reference).

```
[ :SENSE ] :LSEQuencer:TDSCdma:TDEMod:PHASe:SHIFt:DETection:AUTO ON|OFF|1|0
```

```
[ :SENSE ] :LSEQuencer:TDSCdma:TDEMod:PHASe:SHIFt:DETection:AUTO?
```

Mode Parameters

Mode and Measurement Parameters

TD-SCDMA Demod – Timing Reference

Timing Reference setting for TD-SCDMA mode. The available selections include DwPTS, UpPTS and Trigger. For more details about the command see the TD-SCDMA online help (or in pdf format, the User's and Programmer's Reference).

```
[ :SENSe ] :LSEQuencer:TDSCdma:TDEMod:TREFeRence DPTS|UPTS|TRIG
```

```
[ :SENSe ] :LSEQuencer:TDSCdma:TDEMod:TREFeRence?
```

TD-SCDMA Demod – Filter Alpha

Filter Alpha setting for TD-SCDMA mode. It specifies the measurement filter (Root-raised Cosine) alpha. For more details about the command see the TD-SCDMA online help (or in pdf format, the User's and Programmer's Reference).

```
[ :SENSe ] :LSEQuencer:TDSCdma:TDEMod:ALPHa <real>
```

```
[ :SENSe ] :LSEQuencer:TDSCdma:TDEMod:ALPHa?
```

TD-SCDMA Demod – Active Slot Threshold

Active Slot Threshold setting for TD-SCDMA mode. It specifies the Active Slot detection threshold. The unit is dBc (dB below the slot with the largest measured power). For more details about the command see the TD-SCDMA online help (or in pdf format, the User's and Programmer's Reference).

```
[ :SENSe ] :LSEQuencer:TDSCdma:TDEMod:THReShold:SLOT <real>
```

```
[ :SENSe ] :LSEQuencer:TDSCdma:TDEMod:THReShold:SLOT?
```

TD-SCDMA Demod – Active Channel Threshold

Active Channel Threshold setting for TD-SCDMA mode. Active Channel Threshold lets you set the threshold above which a code channel is detected active and included in the Composite Reference waveform. The units are dBc (dB below the total power within the Analysis Timeslot). For more details about the command see the TD-SCDMA online help (or in pdf format, the User's and Programmer's Reference).

```
[ :SENSe ] :LSEQuencer:TDSCdma:TDEMod:THReShold:CHANnel <real>
```

```
[ :SENSe ] :LSEQuencer:TDSCdma:TDEMod:THReShold:CHANnel?
```

```
[ :SENSe ] :LSEQuencer:TDSCdma:TDEMod:THReShold:CHANnel:AUTO ON|OFF|0|1
```

```
[ :SENSe ] :LSEQuencer:TDSCdma:TDEMod:THReShold:CHANnel:AUTO?
```

TD-SCDMA Demod – EVM Result IQ Offset

EVM Result IQ Offset setting for TD-SCDMA mode. The available selections include Standard and Exclude. For more details about the command see the TD-SCDMA online help (or in pdf format, the User's and Programmer's Reference).

```
[ :SENSe ] :LSEQuencer:TDSCdma:TDEMod:EVMResult:IQOFFset STANdard|EXClude
```

```
[ :SENSe ] :LSEQuencer:TDSCdma:TDEMod:EVMResult:IQOFFset?
```

TD-SCDMA Demod – Mirror Frequency Spectrum

Mirror Frequency Spectrum setting for TD-SCDMA mode. The available selections include Normal and Invert. For more details about the command see the TD-SCDMA online help (or in pdf format, the User's and Programmer's Reference).

```
[ :SENSE ] :LSEQuencer:TDSCdma:TDEMod:SPECTrum:MIRRor NORMal | INVert  
[ :SENSE ] :LSEQuencer:TDSCdma:TDEMod:SPECTrum:MIRRor?
```

TD-SCDMA Demod – Limit Test

Limit Test setting for TD-SCDMA mode. For more details about the command see the TD-SCDMA online help (or in pdf format, the User's and Programmer's Reference).

```
[ :SENSE ] :LSEQuencer:TDSCdma:TDEMod:NORMAlize 1 | 0 | ON | OFF  
[ :SENSE ] :LSEQuencer:TDSCdma:TDEMod:NORMAlize?
```

TD-SCDMA Demod – Multi-Carrier Demod

Multi-Carrier Demod setting for TD-SCDMA mode. For more details about the command see the TD-SCDMA online help (or in pdf format, the User's and Programmer's Reference).

```
[ :SENSE ] :LSEQuencer:TDSCdma:TDEMod:MCARrier 1 | 0 | ON | OFF  
[ :SENSE ] :LSEQuencer:TDSCdma:TDEMod:MCARrier?
```

WCDMA HSDPA/HSUPA Enable

HSDPA/HSUPA Enable setting for WCDMA mode. Allows you to specify the HSDPA/HSUPA option enable as On or Off. This selection is necessary because some of the auto detection functions which are expecting an HSPA signal are less tolerant when the signal is noisy or distorted; it should be off when an HSPA signal is not expected. For more details about the command see the W-CDMA online help (or in pdf format, the User's and Programmer's Reference).

```
[ :SENSE ] :LSEQuencer:WCDMa:RADio:CONFIgure:HSDPa [ :STATe ] 0 | 1 | ON | OFF  
[ :SENSE ] :LSEQuencer:WCDMa:RADio:CONFIgure:HSDPa [ :STATe ] ?
```

WLAN Radio Standard

Radio Standard setting for WLAN mode. For more details about the command see the WLAN online help (or in pdf format, the User's and Programmer's Reference).

```
[ :SENSE ] :LSEQuencer:WLAN:RADio:STANdard  
AG | BG | GDO | N20 | N40 | AC20 | AC40 | AC80 | ACT80 | AC160  
[ :SENSE ] :LSEQuencer:WLAN:RADio:STANdard?
```

Mode Parameters

Mode and Measurement Parameters

WLAN Modulation Format

Modulation Format setting for WLAN mode. The commands for different WLAN radio standards are listed in the table below. For more details about the command see the WLAN online help (or in pdf format, the User's and Programmer's Reference).

Radio Standard	Commands
802.11 a/g	[:SENSe] :LSEQuencer:WLAN:DEMod:AG:FORMat AUTO BPSK QPSK QAM16 QAM64 [:SENSe] :LSEQuencer:WLAN:DEMod:AG:FORMat?
802.11g DSSS-OFDM	[:SENSe] :LSEQuencer:WLAN:GDO:FORMat AUTO BPSK QPSK QAM16 QAM64 [:SENSe] :LSEQuencer:WLAN:DEMod:GDO:FORMat?
802.11b/g	[:SENSe] :LSEQuencer:WLAN:DEMod:BG:FORMat AUTO DSSS1 DSSS2 CCK55 CCK11 PBCC55 PBCC11 PBCC22 PBCC33 [:SENSe] :LSEQuencer:WLAN:DEMod:BG:FORMat?
802.11n 20MHz	[:SENSe] :LSEQuencer:WLAN:DEMod:N20:FORMat AUTO BPSK QPSK QAM16 QAM64 SIG [:SENSe] :LSEQuencer:WLAN:DEMod:N20:FORMat?
802.11n 40MHz	[:SENSe] :LSEQuencer:WLAN:DEMod:N40:FORMat AUTO BPSK QPSK QAM16 QAM64 SIG [:SENSe] :LSEQuencer:WLAN:DEMod:N40:FORMat?
802.11ac 20MHz	[:SENSe] :LSEQuencer:WLAN:DEMod:AC20:FORMat AUTO BPSK QPSK QAM16 QAM64 QAM256 SIG [:SENSe] :LSEQuencer:WLAN:DEMod:AC20:FORMat?
802.11ac 40MHz	[:SENSe] :LSEQuencer:WLAN:DEMod:AC40:FORMat AUTO BPSK QPSK QAM16 QAM64 QAM256 SIG [:SENSe] :LSEQuencer:WLAN:DEMod:AC40:FORMat?
802.11ac 80MHz	[:SENSe] :LSEQuencer:WLAN:DEMod:AC80:FORMat AUTO BPSK QPSK QAM16 QAM64 QAM256 SIG [:SENSe] :LSEQuencer:WLAN:DEMod:AC80:FORMat?
802.11ac 80+80MHz	[:SENSe] :LSEQuencer:WLAN:DEMod:ACT80:FORMat AUTO BPSK QPSK QAM16 QAM64 QAM256 SIG [:SENSe] :LSEQuencer:WLAN:DEMod:ACT80:FORMat?
802.11ac 160MHz	[:SENSe] :LSEQuencer:WLAN:DEMod:AC160:FORMat AUTO BPSK QPSK QAM16 QAM64 QAM256 SIG [:SENSe] :LSEQuencer:WLAN:DEMod:AC160:FORMat?

List Sequencer Global Parameters

In addition to the mode and measurement parameters that are set for a sequence, there are also parameters that configure the source and analyzer list sequencers. These parameters can be set up from the front panel or by remote control SCPI commands. For details on how to set up these parameters from the front panel see [Chapter 6, “Front Panel Sequence Setup”, on page 81](#).

NOTE Global parameters cannot be specific to an acquisition; they apply to the entire sequence and to every acquisition in it.

Trigger Timeout

This parameter sets the timeout for trigger events that occur during a sequence. If all **Acquisition Parameters** triggers are set to Free Run, this parameter is ignored. This parameter should be set to a value that exceeds the trigger arming period (the time between the previous acquisition completing and the next trigger). This parameter can be switched ON or OFF. When it is ON, you need to specify a timeout value.

If the Trigger Timeout is ON, and is set to a value greater than the trigger arming period, then the Trigger Timeout is activated on the next non-Free Run trigger in the Sequence. No timeout error is recorded.

If Trigger Timeout is ON, and is set to a value less than the trigger arming period, then an error is flagged and is displayed on the front panel; it can also be returned remotely by sending the command `SYSTEM:ERROR?` (The sequence is aborted only if **Abort on Error** is set to ON.)

The remote command for activating or deactivating the timeout is:

```
[ :SENSE ] :LSEQuencer:TIMEout:TRIGger:STATe OFF|ON|0|1
```

The remote command for setting the value of the timeout is:

```
[ :SENSE ] :LSEQuencer:TIMEout:TRIGger <time>
```

Include Source in Sequence

This parameter determines if the internal source is incorporated into the analyzer sequence. When the source sequence is incorporated in this way, the source sequence is initiated automatically by the analyzer sequence, and cannot be initiated independently.

The remote command for this parameter is:

```
[ :SENSE ] :LSEQuencer:INCLude:SOURce YES|NO|0|1
```

Abort on Limit Fail

This parameter specifies whether or not the test set aborts during a Sequence if any of the measurements in the Sequence exceed the limits set for that measurement. This only applies to measurements which have test limit parameters and which are enabled.

The remote command for this parameter is:

```
[ :SENSE ] :LSEQuencer:ABORT:LIMit:FAIL[:STATE] ON|OFF|0|1
```

Abort on Error

This parameter specifies whether or not the test set aborts during a sequence if the test set returns an error for any of the measurements in the sequence. If set to ON, this parameter causes the list sequencer to stop at the point in the sequence where the error occurs. The current measurement may not be completed; subsequent measurements are not started.

The remote command for this parameter is:

```
[ :SENSe ] :LSEQuencer:ABORT:ERRor [ :STATe ] ON|OFF|0|1
```

NOTE If Abort on Error is set to ON and there are any errors in the error queue, then the measurement aborts immediately. To avoid this send *CLS or clear the error queue prior to starting the measurement.

NOTE If the source list sequencer is running with the analyzer list sequencer, and the analyzer list sequencer aborts due to an error, then the source list sequencer is also aborted.

Input Trigger - RF Burst - Trig Slope

This parameter defines the polarity of the RF Burst trigger input. For a rising edge trigger, set the slope to Positive. For a falling edge trigger, set the slope to Negative.

The remote command for this parameter is:

```
:TRIGger:LSEQuencer:RFBurst:SLOPe POSitive|NEGative
```

Input Trigger - Video - Trig Slope

This parameter defines the polarity of the Video trigger input. For a rising edge trigger, set the slope to Positive. For a falling edge trigger, set the slope to Negative.

The remote command for this parameter is:

```
:TRIGger:LSEQuencer:VIDeo:SLOPe POSitive|NEGative
```

Input Trigger - External Port 1 - Trig Slope

This parameter defines the polarity of the External 1 trigger input. For a rising edge trigger, set the slope to Positive. For a falling edge trigger, set the slope to Negative.

The remote command for this parameter is:

```
:TRIGger:LSEQuencer:EXTErnal1:SLOPe POSitive|NEGative
```

Input Trigger - External Port 1 - Level

This parameter defines the voltage level at the Trigger 1 In port at which triggering occurs.

The remote command for this parameter is:

```
:TRIGger:LSEQuencer:EXTErnal1:LEVel <level>
```

Input Trigger - External Port 2 - Trig Slope

This parameter defines the polarity of the External 2 trigger input. For a rising edge trigger, set the polarity to Positive. For a falling edge trigger, set the polarity to Negative.

The remote command for this parameter is:

```
:TRIGger:LSEQuencer:EXTernal2:SLOPe POSitive|NEGative
```

Input Trigger - External Port 2 - Level

This parameter defines the voltage level at the Trigger 2 In port at which triggering occurs.

The remote command for this parameter is:

```
:TRIGger:LSEQuencer:EXTernal2:LEVel <level>
```

Trigger Holdoff

This parameter sets the trigger holdoff state and time. When the state is On, then the trigger only occurs after the specified holdoff time expires (if the trigger condition is satisfied during the time span). The trigger condition is defined by the Holdoff Type parameter described below.

The state and time remote commands for this parameter is:

```
:TRIGger:LSEQuencer[:SEQuence]:HOLDoff:STATe OFF|ON| 0|1  
:TRIGger:LSEQuencer[:SEQuence]:HOLDoff <time>
```

Holdoff Type

This parameter defines trigger holdoff type (see Trigger Holdoff above) as "Above" or "Below".

"Above": If the trigger slope is positive, a trigger event is generated only if the signal characteristic of interest crosses the trigger threshold (with positive slope) and then remains above the threshold for at least the holdoff time. For negative slope, the trigger event is generated if the signal characteristic crosses the threshold (with negative slope) after having been above the threshold for at least the holdoff time. In either case, the trigger event is associated with the time the level was crossed.

"Below": If the trigger slope is positive, a trigger event is generated only if the signal characteristic of interest crosses the trigger threshold (with positive slope) after having been below the threshold for at least the holdoff time. For negative slope, the trigger event is generated if the signal characteristic crosses the threshold (with negative slope) and then remains below the threshold for at least the holdoff time. In either case, the trigger event is associated with the time the level was crossed.

The remote command for this parameter is:

```
:TRIGger:LSEQuencer[:SEQuence]:HOLDoff:TYPE BELow|ABOVE
```

RF Input Port Mode

When this parameter is set to List, the Acquisition RF Input Port for each acquisition can be set independently. If it is set to FIXed, all the acquisitions will use the same RF Input port setting.

The remote command for this parameter is:

```
[[:SENSe]:LSEQuencer:PORT:INPut:MODE FIXed|LIST
```

Command to set up multiple analysis steps

This command provides a convenient way to generate a list of regular analysis steps for a specified acquisition. The parameters are:

- `stepNumber`: specifies the number of analysis steps to be generated.
- `analysisOffset`: specifies the analysis offset of the first analysis step. Along with the `stepSeparation`, it is used to derive the analysis offset for the rest of analysis steps.
- `analysisInterval`: specifies the analysis interval for each analysis step.
- `stepSeparation`: sets the interval of slot to measure.
- `startPower`: specifies the expected power of the first analysis step. Along with the `powerStep`, it is used to derive the expected power for the rest of analysis steps.
- `powerStep`: sets the power step size.
- `measBitMap`: specifies the measurement bit map for each analysis step.
- `append`: If ON, the new generated analysis steps will be appended at the end of the specified acquisition, otherwise the existing analysis steps will be overwritten by the new generated analysis steps.

When this parameter is set to List, the Acquisition RF Input Port for each acquisition can be set independently. If it is set to FIXed, all the acquisitions will use the same RF Input port setting.

The remote command for this parameter is:

```
[ :SENSe ] :LSEQuencer:ACQuire/{1:1000/}:MASTeps:SETup  
<stepNumber>,<analysisOffset>,<analysisInterval>,<stepSeperation>,<startPower>,<powerStep>,<measBitMap>,<append>
```

Advanced Setup Parameters

These are radio format specific parameters which apply to an entire sequence, and will apply to all acquisitions and measurements related to that radio format.

GSM/EDGE Specific Setup Parameters

Ignore Error In Average

If this parameter is ON, the application does not terminate the analysis step when an error is found. The measurement is made, but all results with errors are excluded from the average. In this case, the actual number of averages may be less than the requested number of averages, because some results were excluded.

```
[ :SENSe ] :LSEQuencer:ASETup:GSM:IEAVerage ON|OFF|1|0
```

```
[ :SENSe ] :LSEQuencer:ASETup:GSM:IEAVerage?
```

PVT Time Offsets

The user may specify 12 offset time values for which power levels can be queried.

```
[ :SENSe ] :LSEQuencer:ASETup:GSM:PVTtime:TIME[:OFFSet] <time>, <time>, <time>, <time>, <time>, <time>, <time>, <time>, <time>, <time>, <time>, <time>
```

```
[ :SENSe ] :LSEQuencer:ASET:GSM:PVT:TIME[:OFFSet]?
```

Loopback BER Pattern, GSM

This parameter allows you to specify (by file or by string) the reference bits used in GSM Loopback BER calculation.

```
:SERvice[:PRODUCTION]:LSEQuencer:ADVanced:GSM:LBER:PATtern <filepath + filename>
```

```
:SERvice[:PRODUCTION]:LSEQuencer:ADVanced:GSM:LBER:PATtern:LOAD {1:4}, <String>
```

```
:SERvice[:PRODUCTION]:LSEQuencer:ADVanced:GSM:LBER:PATtern:LOAD? {1:4}
```

Loopback BER Pattern, EDGE

This parameter allows you to specify (by file or by string) the reference bits used in EDGE Loopback BER calculation.

```
:SERvice[:PRODUCTION]:LSEQuencer:ADVanced:EDGE:LBER:PATtern <filepath + filename>
```

```
:SERvice[:PRODUCTION]:LSEQuencer:ADVanced:EDGE:LBER:PATtern:LOAD {1:4}, <String>
```

```
:SERvice[:PRODUCTION]:LSEQuencer:ADVanced:EDGE:LBER:PATtern:LOAD? {1:4}
```

Mode Parameters

Advanced Setup Parameters

Loopback BER Threshold, GSM

This parameter allows you to specify the threshold level used in GSM Loopback BER calculation. If the BER is below the threshold level, then this result will be available to be accumulated; if above, it will be ignored.

```
:SERVICE[:PRODUCTION]:LSEQUENCER:ADVANCED:GSM:LBBER:DISCARD <real>
```

Loopback BER Threshold, EDGE

This parameter allows you to specify the threshold level used in EDGE Loopback BER calculation. If the BER is below the threshold level, then this result will be available to be accumulated; if above, it will be ignored.

```
:SERVICE[:PRODUCTION]:LSEQUENCER:ADVANCED:EDGE:LBBER:DISCARD <real>
```

LTE-FDD Specific Setup Parameters

LTE-FDD Channel Condition

LTE-FDD Channel Condition determines the limit value of LTE-FDD spectrum flatness (Pass/Fail results of RP1, PR2 RP12 and RP21).

```
:SERVICE[:PRODUCTION]:LSEQUENCER:ADVANCED:LTE:CCONDITION NORMAL|EXTREME  
:SERVICE[:PRODUCTION]:LSEQUENCER:ADVANCED:LTE:CCONDITION?
```

LTE-TDD Specific Setup Parameters

LTE-TDD Channel Condition

LTE-TDD Channel Condition determines the limit value of LTE-TDD spectrum flatness (Pass/Fail results of RP1, RP2, RP12 and RP21).

```
:SERVICE[:PRODUCTION]:LSEQUENCER:ADVANCED:LTETDD:CCONDITION NORMAL|EXTREME  
:SERVICE[:PRODUCTION]:LSEQUENCER:ADVANCED:LTETDD:CCONDITION?
```

WCDMA Specific Setup Parameters

Loopback BER Pattern, WCDMA

This parameter allows you to specify (by file or by string) the reference bits used in WCDMA Loopback BER calculation.

```
:SERVICE[:PRODUCTION]:LSEQUENCER:ADVANCED:WCDMA:LBER:PATTERN <filepath +  
filename>  
:SERVICE[:PRODUCTION]:LSEQUENCER:ADVANCED:WCDMA:LBER:PATTERN:LOAD <String>  
:SERVICE[:PRODUCTION]:LSEQUENCER:ADVANCED:WCDMA:LBER:PATTERN:LOAD?
```

ILPC Measurement, WCDMA

Inner Loop Power Control in the uplink is the ability of the UE to adjust its output power in accordance with TPC (transmit power control) commands received in the downlink. TPC_cmd, along with the power control step size, determines the UE transmit output power. The power change is applied in the timeslot adjacent to the timeslot in which the TPC command is received.

The command which controls the ILPC measurement includes the following parameters:

- Frequency: specifies the frequency to measure of the whole sequence.
- Peak power: specifies the peak power of the whole sequence. Peak power along with test pattern determines the peak power for each acquisition.
- Step size: sets the power control step size for the UE transmitter which is the change in the UE transmitter output power in response to a single TPC_cmd derived at UE.
- Step count: sets the number of timeslots to be measured which equals to the total number of TPC commands sent for the whole sequence.
- Step Interval: specifies the measurement interval for each analysis step. The transient periods of 25us before each slot and 25us after each slot boundary shall not be included in the power measurement per the TS34.121.
- Test Pattern: specifies which test pattern is to be used, DOWN, UP or BOTH (equivalent to DOWN-THEN-UP). Due to the limitation of dynamic range, the whole power control sequence is segmented into two acquisitions when test pattern is set to DOWN or UP. For the BOTH pattern, three acquisitions are required.
- Fast Algorithm Enable: specifies which measurement is configured to acquire the UE output power, Basic TX Power or Basic IQ Power. If fast algorithm enable is on, Basic TX Power is configured on each analysis step, otherwise Basic IQ Power is configured.
- Append enable: optional node, used to specify whether the new generated acquisitions of ILPC will be appended or not. If ON, the new acquisitions will be appended at the end of sequence, otherwise the previous acquisitions will be overwritten by the acquisitions of ILPC.

```
[ :SENSE] :LSEQuencer [:WCDMa] :ILPControl:SETup <frequency>,
< amp1 >, <Integer>, <real>, <time>, UP|DOWN|BOTH, ON|OFF|1|0, ON|OFF|1|0
```

NOTE

This command sets both Upper Limit and Lower Limit of Basic TX Power to OFF internally, therefore no pass or fail result is returned.

TD-SCDMA Specific Setup Parameters

Loopback BER Pattern, TD-SCDMA

This parameter allows you to specify (by file or by string) the reference bits used in TD-SCDMA Loopback BER calculation.

```
:SERVICE[:PRODUCTION]:LSEQUENCER:ADVANCED:TDSCDMA:LBER:PATTERN <filepath + filename>
```

```
:SERVICE[:PRODUCTION]:LSEQUENCER:ADVANCED:TDSCDMA:LBER:PATTERN:LOAD <String>
```

```
:SERVICE[:PRODUCTION]:LSEQUENCER:ADVANCED:TDSCDMA:LBER:PATTERN:LOAD?
```

Loopback BER CodeRMC, TD-SCDMA

This parameter allows you to specify the RMC (Reference Measurement Code) decoder type used in TD-SCDMA Loopback BER calculation. Its type is bool. TRUE means it is single code, FALSE means it is multi code.

```
[ :SENSE ] :LSEQUENCER:ADVANCED:TDSCDMA:LBER:RMC:SCODE TRUE | FALSE
```

```
[ :SENSE ] :LSEQUENCER:ADVANCED:TDSCDMA:LBER:RMC:SCODE?
```

Loopback BER CodenLevel, TD-SCDMA

This parameter allows you to specify the code level of the Reference Measurement Code used in TD-SCDMA Loopback BER calculation.

```
[ :SENSE ] :LSEQUENCER:ADVANCED:TDSCDMA:LBER:CLEVEL <int>
```

```
[ :SENSE ] :LSEQUENCER:ADVANCED:TDSCDMA:LBER:CLEVEL?
```

Loopback BER Code Index0, TD-SCDMA

This parameter allows you to specify the code index of the Reference Measurement Code used in TD-SCDMA Loopback BER calculation. If singleCodeRMC is true, it is only necessary to set this value; if it is false, it is necessary to set this value and also the value of Loopback BER Code Index1.

```
[ :SENSE ] :LSEQUENCER:ADVANCED:TDSCDMA:LBER:CINDEX0 <int>
```

```
[ :SENSE ] :LSEQUENCER:ADVANCED:TDSCDMA:LBER:CINDEX0?
```

Loopback BER Code Index1, TD-SCDMA

This parameter allows you to specify the code index of the Reference Measurement Code used in TD-SCDMA Loopback BER calculation. If singleCodeRMC is true, it is not necessary to set this value; if it is false, it is necessary to set this value and also the value of Loopback BER Code Index0.

```
[ :SENSE ] :LSEQUENCER:ADVANCED:TDSCDMA:LBER:CINDEX1 <int>
```

```
[ :SENSE ] :LSEQUENCER:ADVANCED:TDSCDMA:LBER:CINDEX1?
```

Loopback BER TFCI Detection Mode, TD-SCDMA

This parameter allows you to specify the detection state of TFCI used in TD-SCDMA Loopback BER calculation, Auto or Manual. Its type is bool. True means auto detection mode.

```
:SERVICE[:PRODUCTION]:LSEQUENCER:ADVANCED:TDSCDMA:LBBER:TFCI:AUTO TRUE|FALSE
```

```
:SERVICE[:PRODUCTION]:LSEQUENCER:ADVANCED:TDSCDMA:LBBER:TFCI:AUTO?
```

Loopback BER TFCI Word, TD-SCDMA

This parameter allows you to specify the TFCI word used in TD-SCDMA Loopback BER calculation. Its type is int.

```
:SERVICE[:PRODUCTION]:LSEQUENCER:ADVANCED:TDSCDMA:LBBER:TFCI <int>
```

```
:SERVICE[:PRODUCTION]:LSEQUENCER:ADVANCED:TDSCDMA:LBBER:TFCI?
```

PVT Demodulation State

The parameter specifies if demodulation is needed for TDSCDMA PVT measurement. If this parameter is ON, the midamble of the analysis time slot will be searched and the burst start and stop time will be calculated accordingly; if this parameter is OFF, the burst start and stop timing are calculated by the burst powers. No demodulation is performed.

```
[ :SENSE ] :LSEQUENCER:ADVANCED:TDSCDMA:PVT:DEMOD ON|OFF|1|0
```

```
[ :SENSE ] :LSEQUENCER:ADVANCED:TDSCDMA:PVT:DEMOD?
```

PVT Momentum Criterion

This parameter specifies Momentum Criterion will be used for limit check.

If this parameter is ON, Momentum TDSCDMA PVT limit check criterion will be used. That is, Off Power Before, Average Power over -33rd ~ -14th chip and Off Power After results (see TDSCDMA PVT Results) will be used to compare upper limit -65 dBm, -50 dBm and -65 dBm respectively. If all of these 3 power values are below their upper limits, the TDSCDMA PVT Overall Pass/Fail result will be passed; otherwise, the Overall Pass/Fail result will be failed.

If this parameter is OFF, the TDSCDMA PVT envelope trace will be used to compare with the upper limit trace point by point. If any point of the envelope power trace is less than the upper limit trace, the TDSCDMA PVT Overall Pass/Fail result will be passed; otherwise, the Overall Pass/Fail result will be failed. For the details of envelop trace result and upper limit trace result, please refer to Envelope Trace Results and Upper Limit Results.

```
[ :SENSE ] :LSEQUENCER:ADVANCED:TDSCDMA:PVT:MOMENTUM ON|OFF|1|0
```

```
[ :SENSE ] :LSEQUENCER:ADVANCED:TDSCDMA:PVT:MOMENTUM?
```

Test Set Parameters

In addition to the parameters described early in this chapter, there are also parameters that are used to configure the test set for a sequence. These parameters can be set up from the front panel or by remote control SCPI commands. For details on how to set up these parameters from the front panel see [Chapter 6, “Front Panel Sequence Setup”, on page 81](#).

RF inputs and outputs

There are four RF connectors on the front panel of each TRX, which can be configured as follows:

- **RFIO 1** is a full-duplex port and can be selected as the input port, the output port, or both.
- **RFIO 2** is a full-duplex port and can be selected as the input port, the output port, or both.
- **RF3 I/O** is a half-duplex port and can be selected as the input port or the output port, but not both.
- **RF4 I/O** is a half-duplex port and can be selected as the input port or the output port, but not both.

NOTE It is not possible to have more than one input port at a time, or more than one output port at a time. However, it is possible to use RFIO 1 or RFIO2 as the input port and the output port simultaneously.

Figure 5-1 Front panel input connectors



Mode Parameters
Test Set Parameters

To select the connector to be used as the input port, and the connector to be used as the output port, use the **Input/Output** hardkey on the front panel, or use the following SCPI remote control commands:

To select the input port:

```
[[:SENSE]:FEED:RF:PORT[:INPut] RFIN|RFIO1|RFIO2
```

If the input port is set to "RFIN", this refers to whichever of the half-duplex ports (RF3 I/O and RF4 I/O) has been defined as the input port in the **Input/Output > More > RF Output & Test Set Config > Half Duplex Config > RF Input Port** menu. The equivalent command is:

```
:HDUPlex:PORT:INPut RFIO3|RFIO4
```

To select the output port:

```
[[:SENSE]:FEED:RF:PORT:OUTPut RFOut|RFIO1|RFIO2
```

If the input port is set to "RFOut", this refers to whichever of the half-duplex ports (RF3 I/O and RF4 I/O) has been defined as the input port in the **Input/Output > More > RF Output & Test Set Config > Half Duplex Config > RF Output Port** menu. The equivalent command is:

```
:HDUPlex:PORT:OUTPut RFIO3|RFIO4
```

For more information about the SCPI commands refer to the Sequence Analyzer online help (or in pdf format, the User's and Programmer's Reference).

Corrections

Amplitude corrections can be applied to the output and input ports of the test set when the selected mode is Sequence Analyzer. The Amplitude Corrections arrays can be entered by the user, sent over SCPI, or loaded from a file. The purpose of the corrections is to compensate for losses in signal paths external to the test set. For example, if you have a test system with frequency-dependant path losses due to cable, amplifier or attenuator non-linearities (as in the path illustrated below), and you can quantify the frequency-related variations, you can apply a frequency-dependent correction to the test set analyzer input. In this way the signal appearing at the test set's input port can appear to have the same spectral content as the signal leaving the transmitting device.

Figure 5-2 Corrections

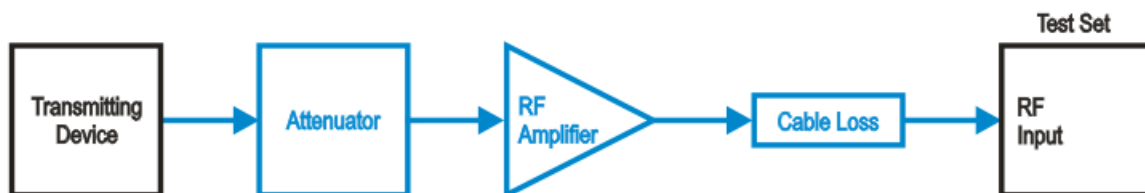

The corrections are applied as a table of x and y parameters, with the x specifying the frequency and y specifying the amplitude correction to be applied at the frequency, x. To enter corrections from the front panel, use the **Input/Output** hardkey and select **Corrections**. For detailed information on how to enter correction data, see the Sequence Analyzer online help (or in pdf format, the User's and Programmer's Reference).

The test set supports up to six sets of correction data. One of these sets (or any combination of the six sets) can be applied to an RF port. In the case of an **RF I/O** port which is being used as an input and an output simultaneously, a correction data set can be applied to the input, the output, or both.

NOTE The same correction data set cannot be applied to more than one port.

The remote control command to apply one of the sets of corrections to a port are as follows:

```
[ :SENSe ] :CORREction:CSET [1 | 2 | 3 | 4 | 5 | 6 :RF:PORT RF | RFIO1 | RFIO2 | RFOut
```

The CSET parameter selects the set of corrections to apply (the sets are identified by numbers 1 to 6) and the RF:PORT parameter selects the port. To apply multiple corrections to a port, send the SCPI command multiple times with the appropriate CSET number selected. For example, to set the corrections in correction files 1, 2 and 4 to the RF Output port send:

```
:CORR:CSET1:RF:PORT RFOut; :CORR:CSET2:RF:PORT RFOut; :CORR:CSET4:RF:PORT RFOut
```

For detailed information on how to enter correction data, see the Sequence Analyzer online help (or in pdf format, the User's and Programmer's Reference).

Mode Parameters
Save and Recall

Save and Recall

If you have set up a sequence, you can save it either from the front panel or by remote control. From the front panel, press the **Save** hardkey and then, select the **Sequences, Save As...** menu. The **Save, Sequences** menu requires that you select whether the type of sequence you are saving is a source sequence, an analyzer sequence or a source and analyzer sequence and in the **Save As...** menu the automatically generated filename is specific to the selected save type.

Figure 5-3 Save a Sequence

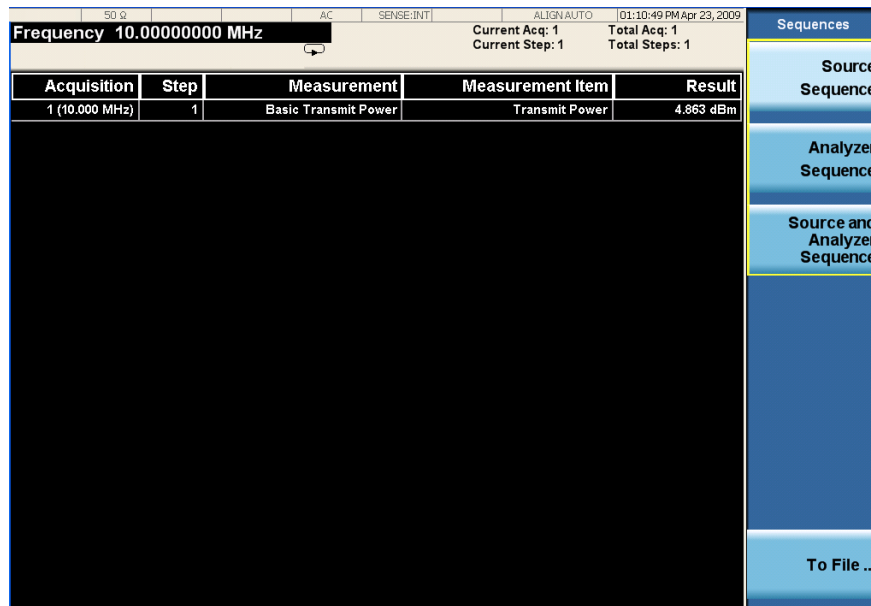

The remote control SCPI command for this feature is

```
:MMEM:STORe:SEQuences: |SLIST |ALIST |SAALIST "MySequence.txt"
```

This command saves the sequence that is currently set up in the test set. You must select whether you are saving a source list sequence, an analyzer list sequence, or a source and analyzer list sequence. The default directory where the file is saved is on the D drive in My Documents\Sequences.

You can use the **Recall, Sequences** on the front panel, followed by the **Recall, Sequences, Open...** menu to load a sequence file into the list sequencer from a directory.

Figure 5-4 Recall a Sequence

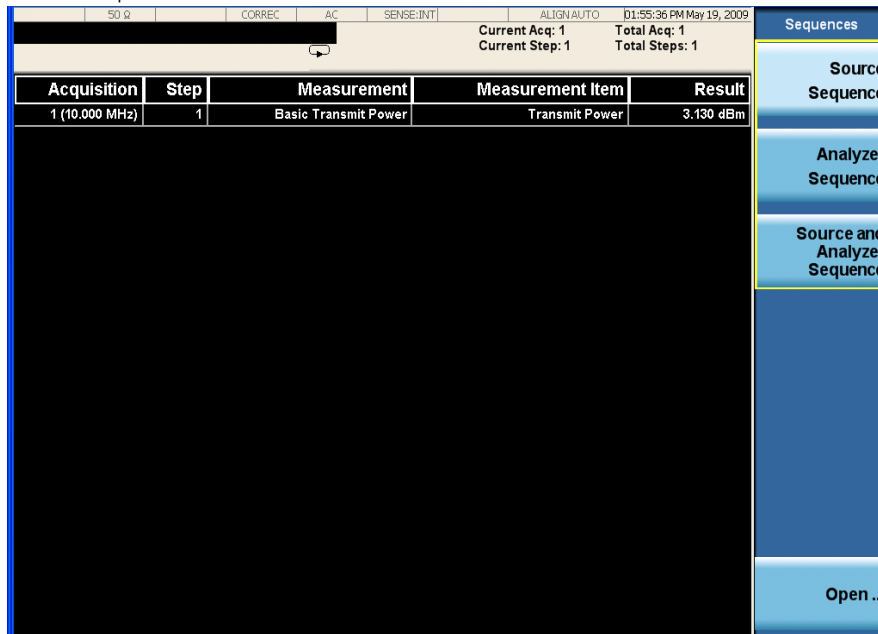

The SCPI command for this feature is

```
:MMEMory:LOAD:SEQuences: |SLIst |ALISt |SAALISt "MySequence.txt"
```

This command recalls a file called MySequence.txt from the D drive in My Documents\Sequences directory and loads it into the list sequencer for immediate use. The Sequence Analyzer mode provides operation in SINGLE sweep mode only and therefore the sequence starts when the front panel hardkey, **Single** or **Restart** is pressed and the appropriate trigger has been received. In remote control operation the sequence is started when the command INITiate:IMMediate or INITiate:REStArt is sent.

For more information about the SCPI commands refer to the Sequence Analyzer online help (or in pdf format, the User's and Programmer's Reference).

Mode Parameters
Save and Recall

6 Front Panel Sequence Setup

This chapter tells you how to set up a sequence using the test set front panel.

The chapter topics are:

- [Front Panel List Sequencer Setup](#)
- [Saving a Sequence](#)
- [Importing a tsv file into a spreadsheet](#)

Front Panel List Sequencer Setup

This chapter shows how to create a sequence (or modify parameters of an existing sequence) from the front panel of the test set. You can then save the sequence to a file using the Save menu. (To recall a previously saved sequence see [“Save and Recall” on page 78](#)).

NOTE Setting up a sequence from the front panel does not provide access to the full flexibility of the list sequencer (for that, it is preferable to use a spreadsheet to set up the sequence, as described in [Chapter 7, “List Sequencer Spreadsheet Data Entry”, on page 97](#)).

Prior to setting up an acquisition and analysis intervals, the measurement, mode, and list sequencer global parameters as described in [Chapter 5, “Mode Parameters”, on page 51](#), should be set up. The mode and measurement parameters cannot be set up from the front panel in Sequence Analyzer mode, but can be set up from the front panel if you are in the required measurement mode. For example, if you are running GSM/EDGE measurements in the Sequence Analyzer mode, change to the GSM/EDGE mode to set up the GSM/EDGE mode and measurement parameters from the front panel; then return to the Sequence Analyzer mode and follow the process described below.

Select mode

To use the list sequencer you need to be in the Sequence Analyzer mode. To change to this mode proceed as follows:

- Step 1.** Press the **Mode** hardkey.
- Step 2.** Press **Sequence Analyzer** softkey.

Figure 6-1 Mode selection

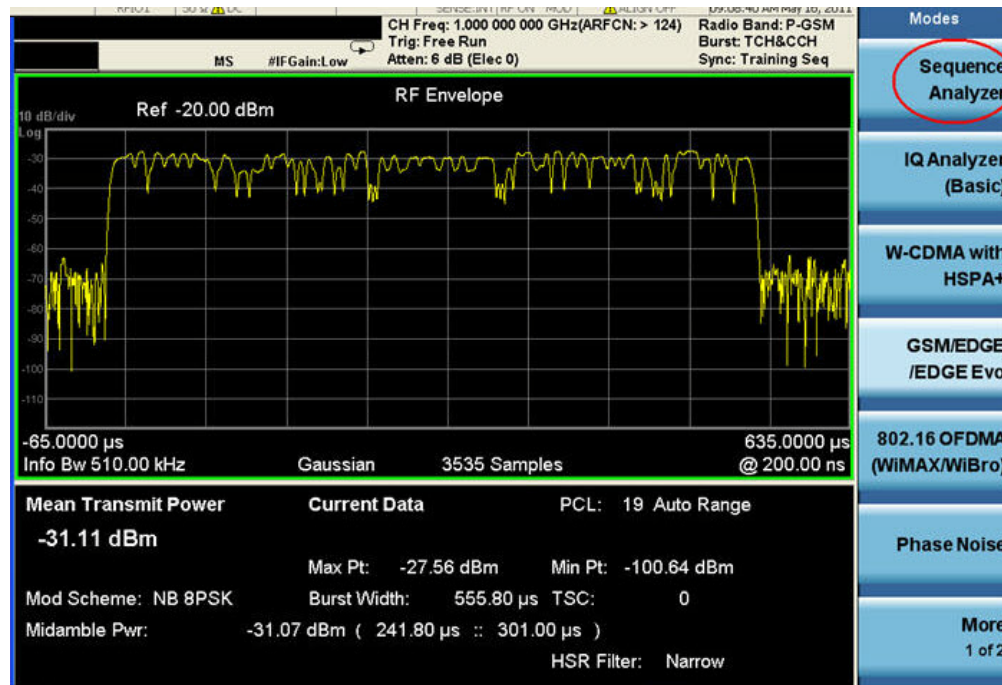

Test set parameter setup

The mechanical attenuation settings should be set up before running the sequence. To set this parameter proceed as follows:

- Press **AMPTD Y Scale** hardkey followed by **Attenuation, Mech Atten** softkeys and set the mechanical attenuation as required.

Note that the Internal Preamp settings are controlled by the Acquisition's Instrument Gain parameter.

Input/Output setup

There are four connectors on the front panel that need to be configured as input and output ports to be used by the list sequencers:

- Step 1. To configure the input port, press the **Input/Output** hardkey and then the **RF Input** and **RF Input Port** softkeys, and select either **RF Input**, **RFIO 1**, or **RFIO 2**. If you select **RF Input**, this refers to whichever of the two half-duplex ports (RF3 I/O or RF4 I/O) is designated as an input.
- Step 2. If you selected **RF Input** in the previous step, press the **Input/Output** hardkey and then the **More**, **RF Output & Test Set Config**, and **Half Duplex Config** softkeys, and press **RF Input Port** to toggle between the RF3 I/O and RF4 I/O settings. Note that designating one of these two ports as the input automatically designates and the other as the output.

Front Panel Sequence Setup

Front Panel List Sequencer Setup

- Step 3. To configure the output port, press the **Input/Output** hardkey and then the **More**, **RF Output & Test Set Config**, and **RF Output Port** softkeys, and press **RF Input Port**. Select **RF Output**, **RFIO 1**, or **RFIO 2**. If you select **RF Output**, this refers to whichever of the two half-duplex ports (RF3 I/O or RF4 I/O) was designated as the output in the previous step.

Corrections

At this point it is useful to apply any amplitude corrections to the signals at the front panel ports. To select the RF port to which you want to apply corrections, take the following steps:

- Step 1. Press the **Input/Output** hardkey and then the **More** and **Corrections** softkeys.
- Step 2. In the **Corrections** menu, select **Properties**.
- Step 3. In the **Properties** menu, press **RF Port** and select the port to which to apply the selected correction.
- Step 4. Returning to the **Corrections** menu, press **More** and toggle **Apply Corrections** to on.

To apply more than one set of corrections to the chosen port, change the selected correction in the **Corrections** menu under **Select Correction**. and then select **Corrections, On** in the **Corrections** menu. Up to six sets of corrections can be applied to a signal.

List sequencer global parameter setup

The list sequencer global parameters can be set up from the front panel from within the Sequence Analyzer mode. To set these parameters proceed as follows:

- Step 1.** Press **Meas Setup, Result Type** and set as required (currently, Measurement Metric is the only supported type).
- Step 2.** Press **Meas Setup, Trigger Timeout** and set as required (select On or Off, and set the time in ms).
- Step 3.** Press **Meas Setup, Include Source in Sequence** and set as required (Yes or No). This setting is available only if **Source, List Sequencer, Sequencer** is On.
- Step 4.** Press **Meas Setup, Abort on Limit Fail** and toggle as required (On or Off).
- Step 5.** Press **Meas Setup, Abort on Error** and toggle as required (On or Off).

Set up the input trigger which is either a signal burst at the input RF port or a signal at one of two input trigger connectors on the back panel. Which trigger is used is specified in the acquisition setup.

Press **Meas Setup, Input Trigger Setup, Video, Trig Slope** and toggle as required (Positive or Negative).
or

- Step 1.** Press **Meas Setup, Input Trigger Setup, External 1, Trigger Level** and set as required (level in Volts).

Step 2. Press **Meas Setup, Input Trigger Setup, External 1, Trig Slope** and set as required (Positive or Negative).

or

Step 1. Press **Meas Setup, Input Trigger Setup, External 2, Trigger Level** and set as required (level in Volts).

Step 2. Press **Meas Setup, Input Trigger Setup, External 2, Trigger Slope** and set as required (Positive or Negative).

Set up the trigger holdoff, if required:

Press **Meas Setup, Input Trigger Setup, Trigger Holdoff, Trig Slope** and toggle as required (Positive or Negative).

Step 1. Press **Meas Setup, Input Trigger Setup, Trigger Holdoff, Trigger Holdoff** and set as required (time in seconds).

Step 2. Press **Meas Setup, Input Trigger Setup, Trigger Holdoff, Holdoff Type** and set as required (Below or Above).

Press **Meas Setup, Multiport Adaptr Input Mode** and toggle as required (List or Fixed). If Fixed is selected, the Multiport Adpater Input Port remains the same throughout the sequence, and is as defined on the **Input/Output** menu (see **“Input/Output setup” on page 83**). If List is selected, the Multiport Adapter Input Port can be set independently for each acquisition, as defined by a sequence parameter (see **“Acquisition setup” on page 87**).

Front Panel Sequence Setup
Front Panel List Sequencer Setup

Basic Measurement setup

If you are including any of the basic measurements in the sequence, set the parameters from the front panel from within the Sequence Analyzer mode as follows:

Step 1. Press **Meas Setup, Basic Meas Setup** and select from the following:

- **Basic Transmit Power Setup**
- **Freq and Phase Error Setup**
- **Basic Discrete PAVT Setup**
- **Basic IQ Data Setup**

Step 2. If you have selected **Basic Transmit Power**, then select a radio standard (**Meas Setup, Acquisition Setup, Radio Setup, Radio Standard**). Optionally, set **Upper** and **Lower limits** to the received power (in dB or -dB). (When you select **Radio Standard**, further selections include **Digital IF BW, Filter Type, Filter BW, and Filter Alpha** settings.)

Step 3. If you have selected **Freq and Phase Error Setup**, specify the **Digital IF BW**, in MHz, and set the **Limit: FreqError** (On or Off, plus the limit value in ppm).

Step 4. If you have selected **Basic Discrete PAVT Setup**, specify the **Filter Type** (Wide, Narrow, Very Narrow, or Extremely Narrow).

Step 5. If you have selected **Basic IQ Data Setup**, then you need to specify the **Digital IF BW**, in MHz, and specify the **Meas Type** (Raw IQ Data or Amplitude and Phase).

Mode-specific measurement setup

If you are running measurements other than the basic measurements, then you have to change modes to set up the associated measurement parameters from the front panel. For more help in each mode, use the mode online help which can be accessed by pressing the Help hardkey from within each mode:

Step 1. Press the **Mode** hardkey.

Step 2. Press the softkey for one of the modes which run within the Sequence Analyzer to select the licensed mode.

Step 3. In the mode, use the **Meas Setup** hardkey to set up the measurement parameters for the measurements you are performing.

Acquisition setup

If you have changed modes to set up the measurements, change back to Sequence Analyzer mode. To set up an acquisition, proceed as follows:

Step 1. Press **Meas Setup, Acquisition Setup**.

Step 2. Use the **Number of Acquisitions** softkey to set the total number of acquisitions in the sequence. Alternatively, add or remove acquisitions using the **Insert Before Acquisition** and **Delete Acquisition** softkeys.

Step 3. To make choices for a particular acquisition, you must make sure it is selected as the “current” acquisition. See the **Current Acquisition** softkey; if it shows “1”, then any settings you make, in the steps described below, will apply only to the first acquisition. To set up a different acquisition, enter a different number.

Step 4. Use the **Avg Number** softkey to specify the number of averages for the acquisition. This setting applies to all analysis steps in the acquisition, but does not apply to other acquisitions in the sequence.

Step 5. Select **Radio Setup, Radio Standard**. Select a radio standard from among these choices:

- None
- GSM
- EDGE
- W-CDMA
- LTE
- LTE TDD
- TDSCDMA
- WLAN

Step 6. Having selected a radio standard, select one of the radio bands for that standard, using the softkeys which are then displayed.

Step 7. Return to the **Radio Setup** menu, and select the **Device Type**. (However, only the MS type is currently supported.)

Step 8. Return to the **Acq Setup** menu, and set the channel or frequency.

If you have set the radio standard and radio band to values other than “None”, use the **Channel** Softkey to select an appropriate channel number (the test set uses the radio standard, radio band, and channel settings to determine frequency).

Or, if you have set the radio standard or radio band as “None”, use the **Frequency** softkey to set the frequency directly.

Step 9. In the **Acq Setup** menu, set the **Peak Power** in dBm.

- Step 10.** In the **Acq Setup** menu, set the **Transition Time** (a period at the beginning of the acquisition, required for frequency or power changes) the acquisition, in ms or other time units.
- Step 11.** In the **Acq Setup** menu, set the **Acquisition Duration**, in ms or other time units.
- Step 12.** In the **Acq Setup** menu, select the **Input Trigger Type** for the acquisition. The choices are:
- Free Run
 - Video (IF Envelope)
 - Internal
 - External 1
 - External 2
- Step 13.** In the **Acq Setup** menu, set the **Video Trigger Level**, in dBm or -dBm.
- Step 14.** In the **Acq Setup** menu, set the **Input Trigger Delay**, in ms or other time units; the delay value specifies a time difference between the acquisition trigger (as configured in the two previous steps) and the actual start of the acquisition.
- Step 15.** In the **Acq Setup** menu, use the **Output Trigger** softkey to select **None** or **Internal**.
- Step 16.** In the **Acq Setup** menu, use the **Multiport Adptr Input, Input Port** softkey to select **None** or **RFIO 0 - RFIO 7**.
- Step 17.** In the **Acq Setup** menu, use the **Acquisition Integration** softkey to select **Normal, Primary, Lower, Upper, or Range Ext**.

Analysis Interval setup

To set up an analysis interval proceed as follows:

- Step 1.** Press **Meas Setup, Acquisition Setup, Analysis Step Setup**.
- Step 2.** Use the **Number of Analysis Steps** softkey to set the total number of analysis steps in the acquisition. Alternatively, add or remove acquisitions using the **Insert Before Analysis Step** and **Delete Analysis Step** softkeys.
- Step 3.** To make choices for a particular analysis step, you must make sure it is selected as the “current” analysis step. See the **Current Analysis Step** softkey; if it shows “1”, then any settings you make, in the steps described below, will apply only to the first analysis step. To set up a different analysis step, enter a different number.
- Step 4.** In the **Analysis Step Setup** menu, use the **Analysis Offset** softkey to specify the delay between the start of the acquisition and the start of the current analysis interval.
- Step 5.** In the **Analysis Step Setup** menu, use the **Analysis Interval** softkey to specify the duration of the current analysis interval.
- Step 6.** In the **Analysis Step Setup** menu, select **Measurement Bit Map** and set the desired measurements from the menu of choices to “On”. The choices are:
 - Basic Transmit Power
 - Basic Freq and Phase Error
 - Basic PAVT
 - Basic IQ Data
 - Power vs Time
 - Output RF Spectrum
 - GMSK Phase & Frequency
 - EDGE EVM
 - Adjacent Chan Power
 - Spectrum Emission Mask
 - Occupied BW
 - Mod Accuracy
 - QPSK EVM
 - Code Domain
 - Phase Discon
 - Loopback BER
 - MIMO EVM

Front Panel Sequence Setup
Front Panel List Sequencer Setup

Step 7. In the **Analysis Step Setup** menu, use the **Expected Power at DUT Output** softkey to set the expected power level in dBm.

To run a Sequence

Once you have set up all mode, measurement, global list sequencer, and acquisition parameters you can start the sequence. The Sequence Analyzer mode typically operates in SINGLE sweep mode and therefore the sequence starts when the front panel hardkey, **Single** or **Restart** is pressed and the appropriate trigger has been received.

Front panel source sequence setup

The source list sequencer can be set up using the front panel to generate an output either separately or simultaneously with the analyzer list sequencer. To access the full flexibility of the list sequencer it is recommended that you use the spreadsheet to set up the sequence (see [Chapter 7, “List Sequencer Spreadsheet Data Entry”, on page 97](#)).

This chapter as well as showing you how to create a sequence from the front panel is useful information if you have already loaded a sequence file into the list sequencer and you are using the front panel to modify parameters. You can subsequently save the changes you make to a new sequence file using the Save menu.

To set up a sequence proceed as follows:

Step 1. Press **Source, List Sequencer, List Sequencer Setup**.

Step 2. Use the **Number of Steps** softkey to set the total number of source steps in the sequence. Alternatively, add or remove steps using the **Insert Step Before, Delete Step, or Clear List** softkeys.

Step 3. To make choices for a particular step, you must make sure it is selected as the “current” step. See the **Current Step** softkey; if it shows “1”, then any settings you make, in the procedure described below, will apply only to the first step. To set up a different step, enter a different number.

Step 4. In the **List Sequencer Setup** menu, select **Step Trigger** for the source step. The choices are:

- Free Run
- Internal
- Manual (Trigger Key)
- **Bus**
- **External 2**

Step 5. In the **List Sequencer Setup** menu, set the **Transition Time** for the source step.

Step 6. In the **List Sequencer Setup** menu, select **Radio Setup, Radio Standard**. Select a radio standard for the source step from among these choices:

- None
- GSM
- EDGE
- W-CDMA
- LTE
- LTE TDD
- TDSCDMA

- Step 7.** Having selected a radio standard, select one of the radio bands for that standard, using the softkeys which are then displayed.
- Step 8.** Return to the **Radio Setup** menu, and select the **Radio Band Link** (Downlink or Uplink.)
- Step 9.** Return to the **List Sequencer Setup** menu, and set the channel or frequency.
- Step 10.** If you have set the radio standard and radio band to values other than “None”, use the **Channel** Softkey to select an appropriate channel number (the test set uses the radio standard, radio band, and channel settings to determine frequency).
- Step 11.** Or, if you have set the radio standard or radio band as “None”, use the **Frequency** softkey to set the frequency directly.
- Step 12.** In the **List Sequencer Setup** menu, set the **Power** in dBm.
- Step 13.** In the **List Sequencer Setup** menu, select the **Waveform** for the source step (use the submenu that is displayed to select a waveform from memory, continue playing the waveform from the previous step in the sequence, generate a CW tone, or select “Off”).
- Step 14.** In the **List Sequencer Setup** menu, set the **Step Duration** for the source step.
- Step 15.** In the **List Sequencer Setup** menu, use the **Output Trigger** softkey to select “On” or “Off”.
- Step 16.** In the **List Sequencer Setup** menu, use the **Multiport Adptr Output Port** softkey to select “List” or “Fixed”.

The values you select are updated on the display as you change them.

To start the sequence, press **Source, List Sequencer** and set the **Sequencer** button to “On”. Then select **Initiate Sequence**.

Front Panel Sequence Setup

Saving a Sequence

Saving a Sequence

To save the sequence that you have set up using the front panel, on the front panel, press **Save, Sequences**. Select the type of sequence (Source, Analyzer, or Source and Analyzer) to be saved. Then select **To File...**

Figure 6-2 Save a Sequence



In the **Save As** dialog box save the file on the D-drive in My Documents\Sequences. The file is automatically saved as a tab separated value (.txt) file. This file can be used to set up the same sequence at a later date using the Recall function.

Figure 6-3 Save As dialog box



Front Panel Sequence Setup
Importing a tsv file into a spreadsheet

Importing a tsv file into a spreadsheet

The tab separated value (tsv) file can be imported into a spreadsheet for ease of viewing and subsequent editing. To do this, open the spreadsheet and select **File, Open**. In the **Open** dialog box, change the **Files of type:** entry to **Text Files (*.prn; *.txt; *.csv)**

Figure 6-4 Spreadsheet Open dialog box

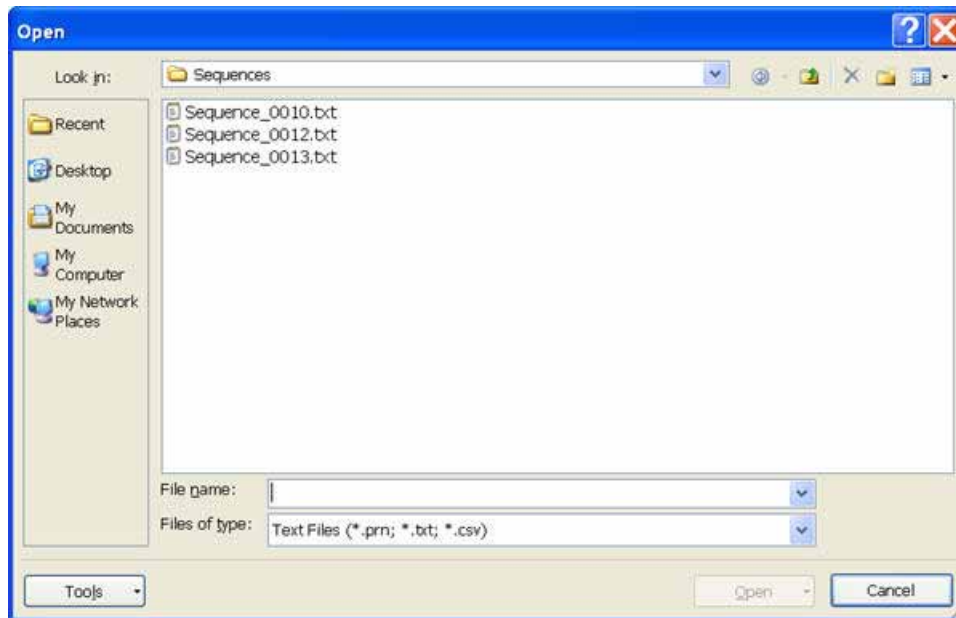

Select a .txt file to open, and select **Open**. The **Text Import Wizard - Step 1 of 3** dialog box opens. The Text Wizard detects that the file is a tab separated values file and automatically selects the **Delimited** radio button. Select **Next >**. The **Delimiters** box should have **Tab** checked. Select **Next >**. Select the **Column data format** as **General**. Select **Finish**.

You can edit the spreadsheet values as required and save the spreadsheet as a new tsv file for use in the Sequence Analyzer mode. Further information on setting up the spreadsheet is available in [Chapter 7, “List Sequencer Spreadsheet Data Entry”, on page 97](#).

7 List Sequencer Spreadsheet Data Entry

This chapter shows you how to make and fill in the spreadsheet, how to generate a tab separated file from the spreadsheet and then how to load this into the list sequencer.

The chapter topics are:

- [Tab separated value file](#)
- [Spreadsheet setup](#)
- [TSV file generation](#)
- [Loading a tsv file into the List Sequencer](#)
- [Tab separated value file editing](#)

Tab separated value file

A tab separated value (tsv) file can be used to store the settings associated with both analyzer and source sequences. There are two ways to generate the tsv file. You can set up the source and analyzer sequences using the front panel (see **Chapter 6**) and then save the sequence settings using the Save front panel hardkey. The values you have entered are saved into a tsv file. Alternatively, you can use a spreadsheet to generate a tsv file. The tsv file generated from the spreadsheet is then saved to the D-drive on the test set in My Documents\Sequences and can be used to set up the List Sequencers.

The tsv file generation can also be done remotely using SCPI commands.

This chapter shows you how to enter data into a spreadsheet to quickly and easily generate a tsv file for use in the list sequencers. A specially designed spreadsheet template is available on the Keysight web or simply use the guidelines below to make your own. You can take a copy of the spreadsheet template and enter values for the Sequence, Acquisitions, Analysis Intervals and source Sequences and Steps as required.

The tsv file which you generate should be stored in My Documents\Sequences on D-drive of the test set, in order to use it in the list sequencers. To import the tsv file into the list sequencers, either specify the file name as a SCPI command parameter or from the front panel use the Recall hardkey menu.

If you set the list sequencers up from the front panel, you can save your sequence settings using the Save hardkey menu (see **“Save and Recall” on page 78**).

Spreadsheet setup

Using a spreadsheet to enter data into the Sequence Analyzer, provides a quick and easy way to generate a tab separated file which is used directly on the test set to set up the source and/or analyzer List Sequencer.

An example of a spreadsheet, showing an analyzer sequence combined with a source sequence, is shown in **Figure 7-1**.

Figure 7-1 Sample spreadsheet

#Seq Number	Radio Standard	Radio Band	Device	Freq(MHz) Chan	Number of Messages	Final Power (dBm)	VarGain Type	Transition Time (ms)	Acquisition Duration (ms)	Input Trigger Type	Input Trigger Level	Input Trigger Delay (ms)	Acquisition Status Trigger	Init Delay (ms)	Multiple Refer Input Port	Huber Adapter Present	Resolution Integration	Any RF Input Port	Analysis Step Number	Analysis Step Duration (ms)	Analysis Step Interval (ms)	Measurement Delay	Signal Power (dBm)	
###																								
1	GSM	PGSM	BTS	512	1	0	LOW	.5	0.72	VIDEO	-10	0	INTERNAL	.20	OFF	OFF	NORMAL	RFInput	1	0.02	0.7	111	-5	
1	GSM	PGSM	BTS	513	1	0	LOW	.5	0.72	VIDEO	-10	0	INTERNAL	.20	OFF	OFF	NORMAL	RFInput	1	0.02	0.1	1025	-5	
1	GSM	PGSM	BTS	1514	1	0	LOW	.5	0.72	VIDEO	-10	0	INTERNAL	.20	OFF	OFF	NORMAL	RFInput	2	0.44	0.1	11	-5	
1																			1	0.02	0.7	111	-5	
2																			2	0.195	0.533	11	-5	
3																			3	0.445	0.533	111	-5	
### Source																								
1	INTERNAL	1	PGSM	UP	722	-55	tw01 wfm	TIME	4.02	OFF														
2	INTERNAL	1.3	PGSM	UP	1058	-35	tw02 adm	COUN	13	OFF														

In order to generate a tab separated values file that can be used in the list sequencers, the spreadsheet layout should adhere to the following rules which can also be seen in the example in **Figure 7-1**:

- All row entries should start in column 1 (leftmost column).
- All rows that start with a single # are treated as comment rows and are ignored by the list sequencers. (The optional rows showing the names of the parameters begin with “#”).
- A row with the string “### Analyzer Parameters ###” in the 1st column marks the start of the Analyzer List Sequencer parameters.
- The next row contains the parameters for the first acquisition in the sequence (shown in red in the illustration), and should have the number 1 in column 1.
- The next row contains the parameters for the first analysis step in the acquisition (shown in blue in the illustration). If there were no analysis steps associated with acquisition 1, then this row would be replaced by a row containing the parameters for acquisition 2.
- In an analysis step row, the analysis number should start and 1 and increment by 1 for every analysis step in an acquisition.
- Rows are populated as required using **Figure 7-1** as a guide (acquisition number should increment by 1 in column 1 for every acquisition).
- If you are using the test set source list sequencer, then this information appears in the spreadsheet after the analyzer sequence information.
- A row with the string “### Source Parameters ###” in the 1st column marks the start of the Source List Sequencer parameters.
- The next row contains the parameters for the first source step, with the number 1 in column 1.

List Sequencer Spreadsheet Data Entry
Spreadsheet setup

- The following rows contain the information for successive source steps with the number in column 1 incrementing in each row.

Table 7-1 Allowed entries for spreadsheet for analyzer list sequencer setup (radio parameters)

Radio Standard	Radio Band								
None									
GSM or EDGE	NONE	PGSM	EGSM	RGSM	DCS1800	PCS1900	GSM450	GSM480	GSM850
	GSM700	TGSM810							
WCDMA	NONE	BAND I	BAND II	BAND III	BAND IV	BAND V	BAND VI	BAND VII	BAND VIII
	BAND IX	BAND X	BAND XI	BAND XII	BAND XIII	BAND XIV			
LTE or LTE TDD	NONE	BAND 1	BAND 2	BAND 3	BAND 4	BAND 5	BAND 6	BAND 7	BAND 8
	BAND 9	BAND 10	BAND 11	BAND 12	BAND 13	BAND 14	BAND 17	BAND 18	BAND 19
	BAND 20	BAND 21	BAND 24	BAND 25	BAND 26	BAND 27	BAND 28		
LTE TDD	NONE	BAND 31	BAND 33	BAND 34	BAND 35	BAND 36	BAND 37	BAND 38	BAND 39
	BAND 40	BAND 41	BAND 42	BAND 43	BAND 44				
TD SCDMA	NONE	BAND A	BAND B	BAND C	BAND D	BAND E	BAND F		

Table 7-2 Allowed entries for spreadsheet for analyzer list sequencer setup (general parameters)

Spreadsheet entry	Allowed values				
Radio Standard	(See previous table)				
Radio Band	(See previous table)				
Device	MS				
Freq/Chan	Enter a frequency in MHz, or a channel number as an integer.				
# Averages	Integer				
Peak Power	Integer				
Instrument Gain Type (not applicable to E6650A)	ZERO	LOW	HIGH		
Transition Time	Real number (in ms)				
Acq duration	Real number (in ms)				
Input Trigger Type	IMMEDIATE	EXTERNAL 1	EXTERNAL 2	VIDEO	INTERNAL
Input Trigger level	Positive or Negative real number (in dBm)				
Input Trigger Delay	Real number (in ms)				
Output Trigger	NONE	INTERNAL	EXTERNAL1		

Table 7-2 Allowed entries for spreadsheet for analyzer list sequencer setup (general parameters)

Instrument Gain LOW Value (not applicable to E6650A)	Positive or Negative real number (in dBm)				
Multiport Adapter Input Port (not applicable to E6650A)	OFF	RFIO 0 - RFIO 7			
Multiport Adapter Preamp (not applicable to E6650A)	OFF	ON			
Acquisition Integration	NORMal	PRIMary	LOWer	UPPer	RANGe
Acquisition RF Input Port	RFIO1	RFIO2	RFIN		

Table 7-3 Allowed entries for spreadsheet for source list sequencer setup (general parameters)

Radio Band							
NONE	PGSM	EGSM	RGSM	DCS1800	PCS1900	GSM450	GSM480
GSM850	GSM700	TGSM810	BANDI	BANDII	BANDIII	BANDIV	BANDV
BANDVI	BANDVII	BANDVIII	BANDIX	BANDX	BANDXI	BANDXII	BANDXIII
BANDXIV	USCELL	USPCS	JAPAN	KOREAN	NMT	IMT2K	UPPER
SECOND	PAMR400	PAMR800	IMTEXT	PCS1DOT9G	AWS	US2DOT5G	PUBLIC
LOWER	BAND1	BAND2	BAND3	BAND4	BAND5	BAND6	BAND7
BAND8	BAND9	BAND10	BAND11	BAND12	BAND13	BAND14	BAND17
BAND18	BAND19	BAND20	BAND21	BAND24	BAND25	BAND26	BAND27
BAND28	BAND31	BAND31	BAND33	BAND34	BAND35	BAND36	BAND37
BAND38	BAND39	BAND40	BAND41	BAND42	BAND43	BAND44	BANDA
BANDB	BANDC	BANDD	BANDE	BANDF			

Table 7-4 Allowed entries for spreadsheet for source list sequencer setup (general parameters)

Spreadsheet entry	Allowed values				
Step Trigger	IMMEDIATE	KEY	BUS	INTERNAL	EXTERNAL
Transition Time	Time (in ms)				
Radio Band	(See previous table)				
Radio Band Link	UP	DOWN			
Freq/Chan	Enter a frequency in MHz, or a channel number as an integer.				
Power	Real value (in dBm)				

List Sequencer Spreadsheet Data Entry
 Spreadsheet setup

Table 7-4 Allowed entries for spreadsheet for source list sequencer setup (general parameters)

Waveform	<filename> (waveform file currently loaded into ARB memory)	CONT	CW	OFF
Step Duration	TIME	COUNT	CONTInuous	
Time / Count	Time (in ms)			
Output Trigger	None		Internal	External 2

NOTE A fast way to populate a spreadsheet which has uniformly distributed values across multiple cells is to enter values in the first two cells in the spreadsheet, select the spreadsheet cells, click and hold the small square at the bottom right of the selection and pull the square across the rows or columns that you require. The parameters are incremented by the same amount as in the first two cells.

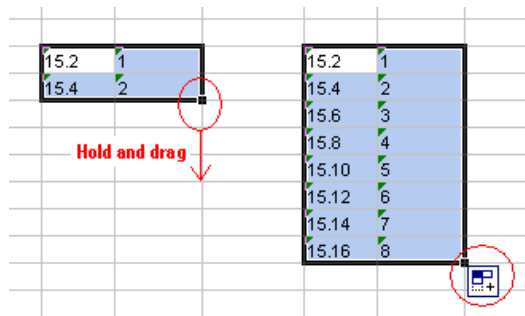

TSV file generation

To save the spreadsheet as a tab separated value file select the file type in the Save As dialog box as Text (Tab delimited)(* .txt). To use the tsv file on the test set, it should be placed in My Documents\Sequences directory on the D-drive of the test set.

Figure 7-2 Saving spreadsheet as tsv file

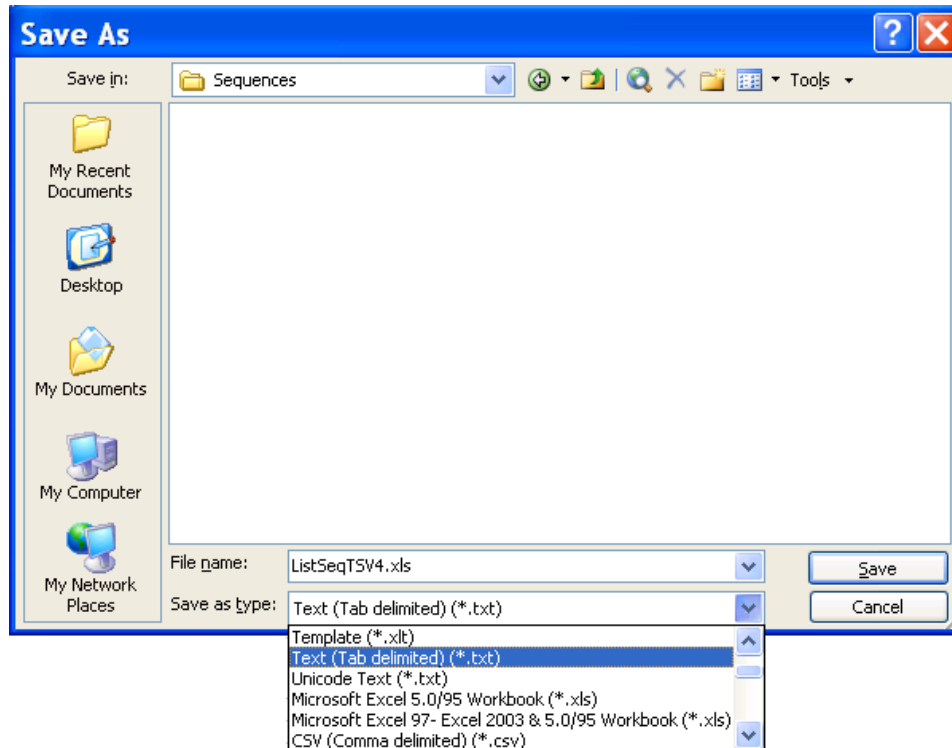

Loading a tsv file into the List Sequencer

Once the tsv file is in the My Documents\Sequences directory on the test set it is imported into the List Sequencer using the Recall hardkey menu.

Step 1. Press **Recall, Sequences**

Step 2. Select from **Source Sequence, Analyzer Sequence** or **Source and Analyzer Sequence.**

Step 3. Select **Open....**

Step 4. In the Open dialog box, select a sequence file and select Open (see [Figure 7-3](#)). The selected file is now ready for use in the list sequencer.

Figure 7-3 Load tsv file

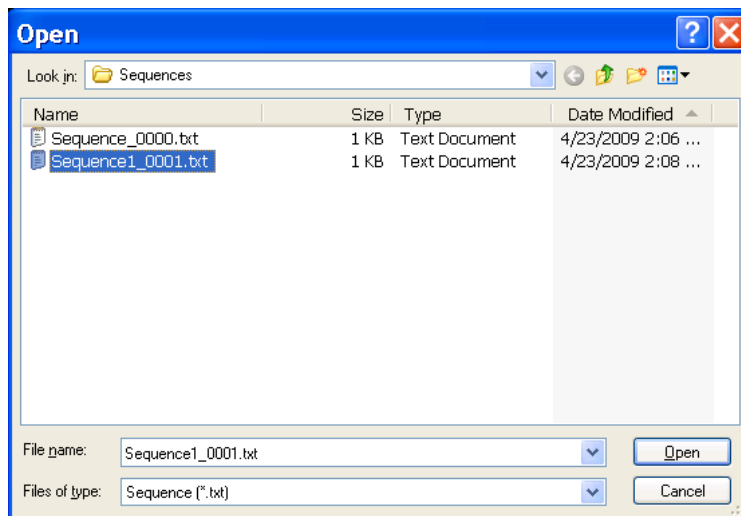

Tab separated value file editing

The tab separated value (tsv) file which is used by the test set to set up the sequence can be edited using a standard text editor. The tsv file is located in the test set on the D-drive at My Documents\Sequences. The default name of the file is Sequence_###.txt, where ### is a number that is automatically appended when the file is saved. It is easier to edit the tsv file if it is imported into a spreadsheet. To do this see **“Importing a tsv file into a spreadsheet” on page 96.**

List Sequencer Spreadsheet Data Entry
Tab separated value file editing

8 List Sequencer Measurement Results

This chapter describes how the measurements from the List Sequencer are returned.

The chapter topics are:

- [Results at virtual front panel](#)
- [Results by SCPI](#)

Sequence Analyzer measurement results

Measurement results for all the measurements within the sequence are displayed on the virtual front panel and are available remotely using SCPI commands.

Results at virtual front panel

When you are in the list sequencer, the virtual front panel display shows you the results for each measurement in all the analysis intervals you have set up. The results are organized by acquisition (and within each acquisition, by analysis interval) as shown in **Figure 8-1**

To view the results for the Sequence you have set up on the virtual front panel, press the **View/Display, Result Metrics**.

Figure 8-1 Front panel results

Acquisition	Step	Measurement	Measurement Item	Result
1 (10.000 MHz)	1	Basic Transmit Power	Transmit Power	3.710 dBm
1	2	Basic Transmit Power	Transmit Power	--- dBm
1	2	Basic Phase Error	Phase Error	--- °
1	3	Basic Transmit Power	Transmit Power	--- dBm
1	4	Basic Transmit Power	Transmit Power	--- dBm
1	4	Basic Frequency Error	Frequency Error	--- Hz
1	5	Basic Transmit Power	Transmit Power	--- dBm
1	6	Basic Transmit Power	Transmit Power	--- dBm
1	6	Basic Phase Error	Phase Error	--- °
1	7	Basic Transmit Power	Transmit Power	--- dBm
1	7	Basic Frequency Error	Frequency Error	--- Hz
1	8	Basic Transmit Power	Transmit Power	--- dBm
1	8	Basic Frequency Error	Frequency Error	--- Hz
1	9	Basic Transmit Power	Transmit Power	--- dBm
1	9	Basic Frequency Error	Frequency Error	--- Hz
1	10	Basic Transmit Power	Transmit Power	--- dBm
1	10	Basic Frequency Error	Frequency Error	--- Hz

Results by SCPI

Three slightly different commands can be used to obtain measurement results. For all of these commands, the subopcode 1, 2, and 3 determine how much of the total measurement result is returned: all of it (1), only a pass/fail result for the sequence (2), or the first failing measurement, identified by acquisition number, analysis step number, and bitmap number of the measurement. If no subopcode is given, 1 is assumed.

NOTE For all of these commands, the subopcode 1, 2, and 3 determine how much of the total measurement result is returned: all of it (1), only a pass/fail result for the sequence (2), or the first failing measurement, identified by acquisition number, analysis step number, and bitmap number of the measurement (3). If no subopcode is specified, 1 is assumed.

`:FETCh:LSEQuencer [1] | 2 | 3?`

As the `FETCh` command only returns the results from the buffer, and does not initiate a sequence, this command would be used to read results previously captured, or else would follow an `:INITiate:LSEQuencer` command.

`:READ:LSEQuencer [1] | 2 | 3?`

The `READ` command initiates the sequence and then returns the results.

`:MEASure:LSEQuencer [1] | 2 | 3?`

The `MEASure` command presets the sequence and measurement parameters to their default values, initiates the sequence, and then returns the results. In most cases, this is not useful in Sequence Analyzer mode; the `FETCh` and `READ` commands are generally used to obtain sequence results.

NOTE Because it presets the sequence and measurement parameters to their default values, the `MEASure` command is usually not useful in Sequence Analyzer mode; sequence results are typically obtained using the `FETCh` and `READ` commands instead.

The same commands can be used more narrowly, to return only the results from a particular acquisition within the sequence (specified by acquisition number):

`:FETCh:LSEQuencer [1] :ACQuire [1] | 2 | 3 | 4 .. 512?`
`:READ:LSEQuencer [1] :ACQuire [1] | 2 | 3 | 4 .. 512?`
`:MEASure:LSEQuencer [1] :ACQuire [1] | 2 | 3 | 4 .. 512?`

To narrow the focus even further, the commands can be used to return only the results from a particular analysis interval (identified by analysis step number) within a particular acquisition:

`:FETCh:LSEQuencer [1] :ACQuire [1] | 2 | ... | 512 :ASTep [1] | 2 | ... | 1000?`
`:READ:LSEQuencer [1] :ACQuire [1] | 2 | ... | 512 :ASTep [1] | 2 | ... | 1000?`
`:MEASure:LSEQuencer [1] :ACQuire [1] | 2 | ... | 512 :ASTep [1] | 2 | ... | 1000?`

To query the actual average count of a specified analysis step:

List Sequencer Measurement Results

Sequence Analyzer measurement results

```
:FETCh:LSEQuencer [1] : ACQuire [1] | 2 | ... | 512:ASTep [1] | 2 | ... | 1000:AVERage?  
:READ:LSEQuencer [1] : ACQuire [1] | 2 | ... | 512:ASTep [1] | 2 | ... | 1000:AVERage?  
:MEASure:LSEQuencer [1] : ACQuire [1] | 2 | ... | 512:ASTep [1] | 2 | ... | 1000:AVERage?
```

The returned actual average count should be equal to the Avg Number if Ignore Error In Average is OFF, and might be less than or equal to the user setting Avg Number when Ignore Error In Average is set to ON.

Asynchronous FETCh SCPI commands are used to get the results back as soon as possible once the queried results are available. Unlike the normal FETCh commands, the asynchronous FETCh commands do not require you to wait for completion of the entire sequence. For example, you can get the results of the 1st acquisition while the instrument is performing the 2nd or the 3rd acquisition, provided you are using asynchronous FETCh commands.

```
:FETCh:LSEQuencer:ASYNc:ACQuire{1:512}:STATe?/qonly/
```

This scpi command is used to query if the results of the specified acquisition are available. If it returns 0, that means the results are still in calculation. Otherwise, it means the specified acquisition results are ready to query.

```
:FETCh:LSEQuencer:ASYNc:ACQuire{1:512}?/qonly/
```

Return the results of specified acquisition once the results are available, whether the whole sequence is completed or not.

NOTE This SCPI command will be blocked until the results are ready. The results definition is the same as for :FETCh:LSEQuencer:ACQuire{1:512}?/qonly/

```
FETCh:LSEQuencer:ASYNc:ACQuire{1:512}:ASTep{1:1000}?/qonly/
```

Return the results of specified analysis step once the results are available, whether if the whole sequence is completed or not.

NOTE This SCPI command will be blocked until the results are ready. The results definition is the same as for :FETCh:LSEQuencer:ACQuire{1:512}:ASTep{1:1000}?/qonly/

```
:INITiated:
```

This SCPI command provides the capability to indicate if the sequence has finished its initialization. It won't return until the instrument is ready to perform a capture.

NOTE The MEASure query MEAS:LSEQ1|2|3? presets the test set to the default state and returns default results. This has limited application, as a preset returns the Sequence settings and Meas Setup parameters to their default settings, so the results are not useful.

For more detailed information about the SCPI commands above refer to the Sequence Analyzer online help (or in pdf format, the User's and Programmer's Reference).

List Sequencer Measurement Results
Sequence Analyzer measurement results

Results format

Assuming that the subopcode used with the `he FETCH` or `READ` command is 1 or none (indicating that full results are requested), the results returned are as in the table below. In this table, each real value is a “double” or 8 bytes (64 bits).

Step	Result	Comment
1	Total number of real values returned for the Sequence, including this one.	Sequence as a whole.
2	Reserved for Keysight use.	
3	Summary Integrity value for entire Sequence. All integrity values OR'd together.	
4	Total number of Acquisitions for entire Sequence.	
5	Summary Integrity value for Acquisition 1.	Acquisition 1
6	Number of Analysis Intervals in Acquisition 1	
7	Summary Integrity value for Analysis Interval 1	Analysis Interval 1 of Acquisition 1
8	Analysis Interval 1 Measurement Bit Map - decimal representation	
9	Integrity value for 1st measurement in Analysis Interval 1	Measurement 1 of Analysis Interval 1 of Acquisition 1
10	Number of results in first measurement in Analysis Interval 1	
11	Measurement results for first measurement in Analysis Interval 1	
12	Integrity value for 2nd measurement in Analysis Interval 1	Measurement 2 of Analysis Interval 1 of Acquisition 1
13	Number of results in 2nd measurement in Analysis Interval 1	
14	Measurement results for 2nd measurement in Analysis Interval 1	
15	...repeat 12 to 14 for all other measurements in Analysis Interval 1	...other measurements of Analysis Interval 1 of Acquisition 1
16	Summary Integrity value for Analysis Interval 2	Analysis Interval 2 of Acquisition 1
17	Analysis Interval 2 Measurement Bit Map - decimal representation	
18	Integrity value for 1st measurement in Analysis Interval 2	Measurement 1 of Analysis Interval 2 of Acquisition 1
19	Number of results in first measurement in Analysis Interval 2	
20	Measurement results for first measurement in Analysis Interval 2	

List Sequencer Measurement Results
 Sequence Analyzer measurement results

21	Integrity value for 2nd measurement in Analysis Interval 2	Measurement 2 of Analysis Interval 2 of Acquisition 1
22	Number of results in 2nd measurement in Analysis Interval 2	
23	Measurement results for 2nd measurement in Analysis Interval 2	
24	...repeat 21 to 23 for all other measurements in Analysis Interval 2	...other measurements of Analysis Interval 2 of Acquisition 1
25	...repeat 16 to 24 for all other Analysis Intervals in Acquisition 1	...other Analysis Intervals of Acquisition 1
26	...repeat 5 to 25 for Acquisition 2 and for all subsequent Acquisitions in the Sequence	...other Acquisitions in the Sequence

List Sequencer Measurement Results
Sequence Analyzer measurement results

For example, if you have a sequence set up as follows:

- Acquisition 1, Analysis Interval 1, GMSK PFER (phase & frequency error) measurement
- Acquisition 1, Analysis Interval 2, Basic Transmit Power & W-CDMA Mod Accuracy measurements
- Acquisition 2, Analysis Interval 1, GMSK PFER measurement
- Acquisition 2, Analysis Interval 2, Basic Transmit Power & W-CDMA Mod Accuracy measurements

the results would be as follows:

Number of values returned	Order of results returned	Total
1	Total number of real values returned for the Sequence, including this one (= 118)	1
1	Reserved for Keysight use.	2
1	Summary Integrity value for entire Sequence. All integrity values OR'd together.	3
1	Total number of Acquisitions for entire sequence (= 2).	4
1	Summary Integrity value for Acquisition 1.	5
1	Number of Analysis Intervals in Acquisition 1 (= 2)	6
1	Summary Integrity value for Analysis Interval 1	7
1	Analysis Interval 1 Measurement Bit Map, decimal representation (= 64, GMSK PFER)	8
1	Integrity value for first measurement in Analysis Interval 1	9
1	Number of results in GMSK PFER in Analysis Interval 1 (= 17)	10
17	Measurement results for GMSK PFER in Analysis Interval 1	27
1	Summary Integrity value for Analysis Interval 2	28
1	Analysis Interval 2 Measurement Bit Map, decimal representation (= 2049, with Bit 0 and Bit 11 set)	29
1	Integrity value for Basic Transmit Power in Analysis Interval 2	30
1	Number of results in Basic Transmit Power in Analysis Interval 2 (= 4)	31
4	Measurement results for Basic Transmit Power in Analysis Interval 2	35
1	Integrity value for W-CDMA Mod Accuracy in Analysis Interval 2	36
1	Number of results in W-CDMA Mod Accuracy in Analysis Interval 2 (= 24)	37
24	Measurement results for W-CDMA Mod Accuracy in Analysis Interval 2	61
1	Summary Integrity value for Acquisition 2	62

List Sequencer Measurement Results
Sequence Analyzer measurement results

1	Number of Analysis Intervals in Acquisition 2 = 2	63
1	Summary Integrity value for Analysis Interval 1	64
1	Analysis Interval 1 Measurement Bit Map, decimal representation (= 64, GMSK PFER)	65
1	Integrity value for first measurement in Analysis Interval 1	66
1	Number of results in GMSK PFER in Analysis Interval 1 (= 17)	67
17	Measurement results for GMSK PFER in Analysis Interval 1	84
1	Summary Integrity value for Analysis Interval 2	85
1	Analysis Interval 2 Measurement Bit Map, decimal representation (= 2049, with Bit 0 and Bit 11 set)	86
1	Integrity value for Basic Transmit Power in Analysis Interval 2	87
1	Number of results in Basic Transmit Power in Analysis Interval 2 (= 4)	88
4	Measurement results for Basic Transmit Power in Analysis Interval 2	92
1	Integrity value for W-CDMA Mod Accuracy in Analysis Interval 2	93
1	Number of results in W-CDMA Mod Accuracy in Analysis Interval 2 (= 24)	94
24	Measurement results for W-CDMA Mod Accuracy in Analysis Interval 2	11 8

9 Sequence Setup Commands

This chapter describes the SCPI commands which can be used to set parameters for an analyzer sequence or source sequence.

The chapter topics are:

- [Programming Analyzer Sequences \(Combination Commands\)](#)
- [Programming Analyzer Sequences \(Parameter-Specific Commands\)](#)
- [Programming Source Sequences \(Combination Command\)](#)
- [Programming Source Sequences \(Parameter-Specific Commands\)](#)

Programming Analyzer Sequences (Combination Commands)

Analyzer sequence parameters can be set as a group (using a pair of combination commands which set all of the acquisition parameters and analysis step parameters for an acquisition) or independently (using a larger set of parameter-specific commands). This section describes the combination commands.

Acquisition Parameters (Combination)

The parameters for an acquisition can be set by means of a single SCPI command, as described below. To set just one parameter (for a single acquisition, or for all acquisitions in the sequence at once), see [“Acquisition Parameters \(Parameter-Specific Commands\)” on page 119](#).

Remote Command	<pre>[:SENSe]:LSEQuencer:ACQuire [1] 2 3 4 . . . 512 :SETup NONE GSM EDGE WCDMA CDMA2K CDMA1XEV LTE, NONE PGSM EGSM RGSM DCS1800 PCS1900 TGSM810 GSM450 GSM480 GSM850 GSM700 BANDI BANDII BANDIII BANDIV BANDV BANDVI BANDVII BANDVIII BANDIX BANDX BANDXI BANDXII BANDXIII BANDXIV USCELL USPCS JAPAN KOREAN NMT IMT2K UPPER SECOND PAMR400 PAMR800 IMTEXT USPCS1DOT9G AWS US2DOT5G PUBLIC LOWER BAND1 BAND2 BAND3 BAND4 BAND5 BAND6 BAND7 BAND8 BAND9 BAND10 BAND11 BAND12 BAND13 BAND14 BAND17 BAND18 BAND19 BAND20 BAND21 BAND24 BAND25 BAND26 BAND27 BAND28 BAND31 BAND33 BAND34 BAND35 BAND36 BAND37 BAND38 BAND39 BAND40 BAND41 BAND42 BAND43 BAND44 BANDA BANDB BANDC BANDD BANDE BANDF, BTS MS, <real>, <integer>, <ampl>, LOW ZERO HIGH, <time>, <time>, IMMEDIATE VIDEO INTERNAL EXT1 EXT2, <amptd>, <time>, NONE INT, <relative ampl>, OFF RFIO0 RFIO1 RFIO2 RFIO3 RFIO4 RFIO5 RFIO6 RFIO7, ON OFF, NORMAl PRIMary LOWer UPPer RANGe SMIMo, RFIO1 RFIO2 RFIN RFIO3 RFIO4 [:SENSe]:LSEQuencer:ACQuire [1] 2 3 4 . . . 512 :SETup?</pre>
Example	<pre>:LSEQ:ACQ1 GSM, PGSM, MS, 10, 10, 0dB, LOW, 5ms, 50ms, VID, -10dBm, 0, NONE, -20, RFIO0, ON, NORM, RFIO1 :LSEQ:ACQ1?</pre>

Notes	<p>The parameters are:</p> <p><enum> - specifies the Radio Standard for the Acquisition.</p> <p><enum> - specifies the Radio Band for the Acquisition.</p> <p><enum> - specifies the DeviceType for the Acquisition.</p> <p><real> - specifies the Frequency or Channel Number for the Acquisition. The channel number and frequency are combined to one parameter. If the radio band is set to NONE, this value is interpreted as a frequency value in Hz. If the radio band is set to a valid band, this value is interpreted as a channel number.</p> <p><integer> - specifies the Number of Averages for the Acquisition.</p> <p><ampl> - specifies the peak expected power in dB for the Acquisition.</p> <p><enum> - specifies the Instrument Gain Type for the Acquisition (this parameter does not apply to Model E6650A).</p> <p><time> - specifies the Transition Time for the Acquisition.</p> <p><time> - specifies the Duration of the Acquisition.</p> <p><enum> - specifies the Input Trigger Type for the Acquisition.</p> <p><ampl> - specifies the Input Trigger Level for the Acquisition.</p> <p><time> - specifies the Input Trigger Delay for the Acquisition.</p> <p><enum> - specifies the Output Trigger for the Acquisition.</p> <p><relative ampl> - specifies the dB value of Instrument Gain when Instrument Gain Type is set to LOW (this parameter does not apply to Model E6650A).</p> <p><enum> - specifies the step Multiport Adapter Input path selection for the Acquisition (this parameter does not apply to Model E6650A).</p> <p><enum> - specifies the step Multiport Adapter Preamplify On/Off state for the Acquisition (this parameter does not apply to Model E6650A).</p> <p><enum> - specifies the Acquisition Integration (for frequency span extension or dynamic range extension) of the Acquisition.</p> <p><enum> - specifies the Acquisition RF Input Port of the Acquisition.</p>
-------	---

Sequence Setup Commands

Programming Analyzer Sequences (Combination Commands)

Analysis Step Parameters (Combination)

The parameters for an analysis step within an acquisition can be set by means of a single SCPI command, as described below. To set just one parameter (for a single analysis interval, or for all analysis intervals in the acquisition at once), see [“Analysis Step Parameters \(Parameter-Specific Commands\)” on page 131](#).

Remote Command	<code>[[:SENSe]:LSEQuencer:ACQuire [1] 2 3 4 . . 512 :ASTep [1] 2 3 4...1000:SETup <time>, <time>, <integer>, <ampl></code>
Example	<code>:LSEQ:ACQ1:ASTEP1:SETup 20,20,1, -10</code> <code>:LSEQ:ACQ1:ASTEP1:SETup?</code>
Notes	The parameters are: <code><time></code> - specifies the Analysis Offset for the Analysis Step. <code><time></code> - specifies the Analysis Interval for the Analysis Step. <code><integer></code> - specifies the Measurement Bitmap for the Analysis Step (this is the decimal equivalent of the bits selected). <code><ampl></code> - specifies the Expected Power at DUT Output for the Analysis Step.

Programming Analyzer Sequences (Parameter-Specific Commands)

Each of these commands can be used to change just one parameter within an analyzer sequence.

Acquisition Parameters (Parameter-Specific Commands)

This section describes the 18 parameters which configure the test set for an acquisition.

An additional 5 parameters are used to define analysis intervals within an acquisition, as described in **“Analysis Step Parameters (Parameter-Specific Commands)” on page 131**.

1: Acq Number

As acquisitions are simply numbered sequentially within the sequence, there is no parameter-specific command for setting the number of an acquisition. However, in the commands given below, it is necessary to identify the acquisition by number in the ACQUIRE value.

2: Radio Standard

For a description of this parameter, see **“2: Radio Standard” on page 23**. The parameter-specific commands are described below.

SCPI Command	<p>To set the radio standard as an individual value:</p> <pre>[:SENSe] :LSEQuencer :ACQuire { 1 : 512 } :SETup :RADio :STANdard NONE GSM EDGE WCDMA LTE LTETDD TDSCDMA</pre> <pre>[:SENSe] :LSEQuencer :ACQuire { 1 : 512 } :SETup :RADio : STANdard?</pre> <p>To set the radio standard as an array:</p> <pre>[:SENSe] :LSEQuencer :LIST :SETup :RADio :STANdard <enum> , <enum> , <enum> , ...</pre> <pre>[:SENSe] :LSEQuencer :LIST :SETup :RADio :STANdard?</pre> <p>The array form of the command is used to make a different setting for each acquisition in the sequence (the number of array values must match the number of acquisitions; otherwise a "settings conflict" error will occur).</p>
SCPI Examples	<pre>:LSEQ:ACQ2:SET:RAD:STAN LTE :LSEQ:ACQ2:SET:RAD:STAN? :LSEQ:LIST:SET:RAD:STAN NONE,WCDMA,LTE,WCDMA :LSEQ:LIST:SET:RAD:STAN?</pre>

3: Radio Band

For a description of this parameter, see **“3: Radio Band” on page 24**. The parameter-specific commands are described below.

Sequence Setup Commands

Programming Analyzer Sequences (Parameter-Specific Commands)

To set Radio Band to None:

<p>SCPI Command</p>	<p>To set the radio band as an individual value:</p> <pre>[:SENSe] :LSEQuencer :ACQuire { 1 : 512 } :SETup :RADio :BAND NONE</pre> <pre>[:SENSe] :LSEQuencer :ACQuire { 1 : 512 } :SETup :RADio :BAND?</pre> <p>To set the radio band as an array:</p> <pre>[:SENSe] :LSEQuencer :LIST :SETup :RADio :BAND <enum> , <enum> , <enum> , ...</pre> <pre>[:SENSe] :LSEQuencer :LIST :SETup :RADio :BAND?</pre> <p>The array form of the command is used to make a different setting for each acquisition in the sequence (the number of array values must match the number of acquisitions; otherwise a "settings conflict" error will occur).</p>
<p>SCPI Examples</p>	<pre>:LSEQ:ACQ2:SET:RAD:BAND NONE</pre> <pre>:LSEQ:ACQ2:SET:RAD:BAND?</pre> <pre>:LSEQ:LIST:SET:RAD:BAND NONE,NONE,NONE,NONE</pre> <pre>:LSEQ:LIST:SET:RAD:BAND?</pre>

To set a GSM Radio Band:

<p>SCPI Command (for specifying a GSM radio band)</p>	<p>To set the radio band as an individual value:</p> <pre>[:SENSe] :LSEQuencer :ACQuire { 1 : 512 } :SETup :RADio :BAND NONE PGSM EGSM RGSM DCS1800 PCS1900 TGSM810 GSM450 GSM480 GSM700 GSM850</pre> <pre>[:SENSe] :LSEQuencer :ACQuire { 1 : 512 } :SETup :RADio :BAND?</pre> <p>To set the radio band as an array:</p> <pre>[:SENSe] :LSEQuencer :LIST :SETup :RADio :BAND <enum> , <enum> , <enum> , ...</pre> <pre>[:SENSe] :LSEQuencer :LIST :SETup :RADio :BAND?</pre> <p>The array form of the command is used to make a different setting for each acquisition in the sequence (the number of array values must match the number of acquisitions; otherwise a "settings conflict" error will occur).</p>
<p>SCPI Examples (for specifying a GSM radio band)</p>	<pre>:LSEQ:ACQ2:SET:RAD:BAND NONE</pre> <pre>:LSEQ:ACQ2:SET:RAD:BAND?</pre> <pre>:LSEQ:LIST:SET:RAD:BAND PGSM,NONE,GSM850,PGSM</pre> <pre>:LSEQ:LIST:SET:RAD:BAND?</pre>

To set an EDGE Radio Band:

<p>SCPI Command (for specifying an EDGE radio band)</p>	<p>To set the radio band as an individual value:</p> <pre>[:SENSe] :LSEQuencer :ACQuire { 1 : 512 } :SETup :RADio :BAND NONE PGSM EGSM RGSM DCS1800 PCS1900 TGSM810 GSM450 GSM480 GSM700 GSM850</pre> <pre>[:SENSe] :LSEQuencer :ACQuire { 1 : 512 } :SETup :RADio :BAND?</pre> <p>To set the radio band as an array:</p> <pre>[:SENSe] :LSEQuencer :LIST :SETup :RADio :BAND <enum> , <enum> , <enum> , ...</pre> <pre>[:SENSe] :LSEQuencer :LIST :SETup :RADio :BAND?</pre> <p>The array form of the command is used to make a different setting for each acquisition in the sequence (the number of array values must match the number of acquisitions; otherwise a "settings conflict" error will occur).</p>
<p>SCPI Examples (for specifying an EDGE radio band)</p>	<pre>:LSEQ:ACQ2:SET:RAD:BAND NONE :LSEQ:ACQ2:SET:RAD:BAND? :LSEQ:LIST:SET:RAD:BAND PGSM,NONE,GSM850,PGSM :LSEQ:LIST:SET:RAD:BAND?</pre>

To set a WCDMA/HSPA Radio Band:

<p>SCPI Command (for specifying a WCDMA/HSPA radio band)</p>	<p>To set the radio band as an individual value:</p> <pre>[:SENSe] :LSEQuencer :ACQuire { 1 : 512 } :SETup :RADio :BAND NONE BANDI BANDII BANDIII BANDIV BANDV BANDVI BANDVII BANDVIII BANDIX BANDX BANDXI BANDXII BANDXIII BANDXIV</pre> <pre>[:SENSe] :LSEQuencer :ACQuire { 1 : 512 } :SETup :RADio :BAND?</pre> <p>To set the radio band as an array:</p> <pre>[:SENSe] :LSEQuencer :LIST :SETup :RADio :BAND <enum> , <enum> , <enum> , ...</pre> <pre>[:SENSe] :LSEQuencer :LIST :SETup :RADio :BAND?</pre> <p>The array form of the command is used to make a different setting for each acquisition in the sequence (the number of array values must match the number of acquisitions; otherwise a "settings conflict" error will occur).</p>
<p>SCPI Examples (for specifying a WCDMA/HSPA radio band)</p>	<pre>:LSEQ:ACQ2:SET:RAD:BAND NONE :LSEQ:ACQ2:SET:RAD:BAND? :LSEQ:LIST:SET:RAD:BAND BANDII, NONE, BANDIII, BANDXII :LSEQ:LIST:SET:RAD:BAND?</pre>

Sequence Setup Commands

Programming Analyzer Sequences (Parameter-Specific Commands)

To set an LTE FDD Radio Band:

<p>SCPI Command (for specifying an LTE FDD radio band)</p>	<p>To set the radio band as an individual value:</p> <pre>[:SENSe] :LSEQuencer :ACQuire { 1 : 512 } :SETup :RADio :BAND NONE BAND1 BAND2 BAND3 BAND4 BAND5 BAND6 BAND7 BAND8 BAND9 BAND10 BAND11 BAND12 BAND13 BAND14 BAND17 BAND18 BAND19 BAND20 BAND21 BAND24 BAND25 BAND26 BAND27 BAND28 BAND31</pre> <pre>[:SENSe] :LSEQuencer :ACQuire { 1 : 512 } :SETup :RADio :BAND?</pre> <p>To set the radio band as an array:</p> <pre>[:SENSe] :LSEQuencer :LIST :SETup :RADio :BAND <enum>, <enum>, <enum>, ...</pre> <pre>[:SENSe] :LSEQuencer :LIST :SETup :RADio :BAND?</pre> <p>The array form of the command is used to make a different setting for each acquisition in the sequence (the number of array values must match the number of acquisitions; otherwise a "settings conflict" error will occur).</p>
<p>SCPI Examples (for specifying an LTE FDD radio band)</p>	<pre>:LSEQ:ACQ2:SET:RAD:BAND NONE :LSEQ:ACQ2:SET:RAD:BAND? :LSEQ:LIST:SET:RAD:BAND BAND1, NONE, BAND24, BAND21 :LSEQ:LIST:SET:RAD:BAND?</pre>

To set an LTE TDD Radio Band:

<p>SCPI Command (for specifying an LTE TDD radio band)</p>	<p>To set the radio band as an individual value:</p> <pre>[:SENSe] :LSEQuencer :ACQuire { 1 : 512 } :SETup :RADio :BAND NONE BAND33 BAND34 BAND35 BAND36 BAND37 BAND38 BAND39 B AND40 BAND41 BAND42 BAND43 BAND44</pre> <pre>[:SENSe] :LSEQuencer :ACQuire { 1 : 512 } :SETup :RADio :BAND?</pre> <p>To set the radio band as an array:</p> <pre>[:SENSe] :LSEQuencer :LIST :SETup :RADio :BAND <enum>, <enum>, <enum>, ...</pre> <pre>[:SENSe] :LSEQuencer :LIST :SETup :RADio :BAND?</pre> <p>The array form of the command is used to make a different setting for each acquisition in the sequence (the number of array values must match the number of acquisitions; otherwise a "settings conflict" error will occur).</p>
<p>SCPI Examples (for specifying an LTE TDD radio band)</p>	<pre>:LSEQ:ACQ2:SET:RAD:BAND NONE :LSEQ:ACQ2:SET:RAD:BAND? :LSEQ:LIST:SET:RAD:BAND BAND33, NONE, BAND34, BAND41 :LSEQ:LIST:SET:RAD:BAND?</pre>

To set an TD-SCDMA Radio Band:

SCPI Command (for specifying an TD-SCDMA radio band)	<p>To set the radio band as an individual value:</p> <pre>[:SENSe] :LSEQuencer :ACQuire { 1 : 512 } :SETup :RADio :BAND NONE BANDA BANDB BANDC BANDD BANDE BANDF</pre> <pre>[:SENSe] :LSEQuencer :ACQuire { 1 : 512 } :SETup :RADio :BAND?</pre> <p>To set the radio band as an array:</p> <pre>[:SENSe] :LSEQuencer :LIST :SETup :RADio :BAND <enum> , <enum> , <enum> , ...</pre> <pre>[:SENSe] :LSEQuencer :LIST :SETup :RADio :BAND?</pre> <p>The array form of the command is used to make a different setting for each acquisition in the sequence (the number of array values must match the number of acquisitions; otherwise a "settings conflict" error will occur).</p>
SCPI Examples (for specifying an TD-SCDMA radio band)	<pre>:LSEQ:ACQ2:SET:RAD:BAND NONE</pre> <pre>:LSEQ:ACQ2:SET:RAD:BAND?</pre> <pre>:LSEQ:LIST:SET:RAD:BAND BAND1, NONE, BANDB, BANDE</pre> <pre>:LSEQ:LIST:SET:RAD:BAND?</pre>

4: Device (for Channel)

For a description of this parameter, see [“4: Device \(for Channel\)” on page 24](#). The parameter-specific commands are described below.

SCPI Command	<p>To set the device as an individual value:</p> <pre>[:SENSe] :LSEQuencer :ACQuire { 1 : 512 } :SETup :RADio :DEVIce BTS MS</pre> <pre>[:SENSe] :LSEQuencer :ACQuire { 1 : 512 } :SETup :RADio :DEVIce?</pre> <p>To set the device as an array:</p> <pre>[:SENSe] :LSEQuencer :LIST :SETup :RADio :DEVIce <enum> , <enum> , <enum> , ...</pre> <pre>[:SENSe] :LSEQuencer :LIST :SETup :RADio :DEVIce?</pre> <p>The array form of the command is used to make a different setting for each acquisition in the sequence (the number of array values must match the number of acquisitions; otherwise a "settings conflict" error will occur).</p>
SCPI Examples	<pre>:LSEQ:ACQ2:SET:RAD:DEV BTS</pre> <pre>:LSEQ:ACQ2:SET:RAD:DEV?</pre> <pre>:LSEQ:LIST:SET:RAD:DEV BTS, BTS, BTS</pre> <pre>:LSEQ:LIST:SET:RAD:DEV?</pre>

5: Frequency / Channel

For a description of this parameter, see [“5: Frequency / Channel” on page 25](#). The parameter-specific commands are described below.

SCPI Command	<p>To set the channel number/frequency as an individual value:</p> <pre>[:SENSe] :LSEQuencer :ACQuire { 1 : 512 } :SETup :CNFRrequency <real></pre> <pre>[:SENSe] :LSEQuencer :ACQuire { 1 : 512 } :SETup :CNFRrequency?</pre> <p>To set the channel number/frequency as an array:</p> <pre>[:SENSe] :LSEQuencer :LIST :SETup :CNFRFrequency <real>, <real>, <real>, ...</pre> <pre>[:SENSe] :LSEQuencer :LIST :SETup :CNFRFrequency?</pre> <p>The array form of the command is used to make a different setting for each acquisition in the sequence (the number of array values must match the number of acquisitions; otherwise a "settings conflict" error will occur).</p>
SCPI Examples	<pre>:LSEQ:ACQ2:SET:CNFR 150</pre> <pre>:LSEQ:ACQ2:SET:CNFR?</pre> <pre>:LSEQ:LIST:SET:CNFR 1102,1e9,1.3e9,2300</pre> <pre>:LSEQ:LIST:SET:CNFR?</pre>

6: Number of Averages

For a description of this parameter, see [“6: Number of Averages” on page 25](#). The parameter-specific commands are described below.

SCPI Command	<p>To set the average number as an individual value:</p> <pre>[:SENSe] :LSEQuencer :ACQuire { 1 : 512 } :SETup :AVERAge :NUMBer <integer></pre> <pre>[:SENSe] :LSEQuencer :ACQuire { 1 : 512 } :SETup :AVERAge :NUMBer?</pre> <p>To set the average number as an array:</p> <pre>[:SENSe] :LSEQuencer :LIST :SETup :AVERAge :NUMBer <integer>, <integer>, <integer>, ...</pre> <pre>[:SENSe] :LSEQuencer :LIST :SETup :AVERAge :NUMBer?</pre> <p>The array form of the command is used to make a different setting for each acquisition in the sequence (the number of array values must match the number of acquisitions; otherwise a "settings conflict" error will occur).</p>
SCPI Examples	<pre>:LSEQ:ACQ2:SET:AVER:NUMB 3</pre> <pre>:LSEQ:ACQ2:SET:AVER:NUMB?</pre> <pre>:LSEQ:LIST:SET:AVER:NUMB 2,3,4,5</pre> <pre>:LSEQ:LIST:SET:AVER:NUMB?</pre>

NOTE The Number of Averages must not be greater than one when the Measurement Bit Mask (page 132) includes Basic IQ Data.

7: Peak Power

For a description of this parameter, see “7: Peak Power” on page 25. The parameter-specific commands are described below.

SCPI Command	<p>To set the peak power as an individual value:</p> <pre>[:SENSe] :LSEQuencer :ACQuire { 1 : 512 } :SETup :PPOWer < amp > [:SENSe] :LSEQuencer :ACQuire { 1 : 512 } :SETup :PPOWer ?</pre> <p>To set the peak power as an array:</p> <pre>[:SENSe] :LSEQuencer :LIST :SETup :PPOWer < amp > , < amp > , < amp > , ... [:SENSe] :LSEQuencer :LIST :SETup :PPOWer ?</pre> <p>The array form of the command is used to make a different setting for each acquisition in the sequence (the number of array values must match the number of acquisitions; otherwise a "settings conflict" error will occur).</p>
SCPI Examples	<pre>:LSEQ:ACQ2:SET:PPOW 20 dBm :LSEQ:ACQ2:SET:PPOW? :LSEQ:LIST:SET:PPOW 0,10dBm,15dBm :LSEQ:LIST:SET:PPOW?</pre>

8: Instrument Gain Type

NOTE This sequence parameter is used by some Keysight models for which Auto Set RF Levels can be on or off. For E6650A, Auto Set RF Levels is always on, and the test set automatically selects this setting for the acquisition, so this parameter is ignored by the sequencer.

9: Transition Time

For a description of this parameter, see [“9: Transition Time” on page 26](#). The parameter-specific commands are described below.

SCPI Command	<p>To set the transition time as an individual value:</p> <pre>[:SENSe] :LSEQuencer:ACQuire { 1 : 512 } :SETup:TIME: TRANSition <time></pre> <pre>:SENSe] :LSEQuencer:ACQuire { 1 : 512 } :SETup:TIME: TRANSition?</pre> <p>To set the transition time as an array:</p> <pre>[:SENSe] :LSEQuencer:LIST:SETup:TIME:TRANSition <time>, <time>, <time>, ...</pre> <pre>[:SENSe] :LSEQuencer:LIST:SETup:TIME:TRANSition?</pre> <p>The array form of the command is used to make a different setting for each acquisition in the sequence (the number of array values must match the number of acquisitions; otherwise a "settings conflict" error will occur).</p>
SCPI Examples	<pre>:LSEQ:ACQ2:SET:TIME:TRAN 10ms</pre> <pre>:LSEQ:ACQ2:SET:TIME:TRAN?</pre> <pre>:LSEQ:LIST:SET:TIME:TRAN 500us,1ms,2ms</pre> <pre>:LSEQ:LIST:SET:TIME:TRAN?</pre>

10: Acquisition Duration

For a description of this parameter, see [“10: Acquisition Duration” on page 26](#). The parameter-specific commands are described below.

SCPI Command	<p>To set the acquisition duration as an individual value:</p> <pre>[:SENSe] :LSEQuencer:ACQuire { 1 : 512 } :SETup:TIME:DURation <time></pre> <pre>[:SENSe] :LSEQuencer:ACQuire { 1 : 512 } :SETup:TIME:DURation?</pre> <p>To set the acquisition duration as an array:</p> <pre>[:SENSe] :LSEQuencer:LIST:SETup:TIME:DURation <time>, <time>, <time>, ...</pre> <pre>[:SENSe] :LSEQuencer:LIST:SETup:TIME:DURation?</pre>
SCPI Examples	<pre>:LSEQ:ACQ2:SET:TIME:DUR 10ms</pre> <pre>:LSEQ:ACQ2:SET:TIME:DUR?</pre> <pre>:LSEQ:LIST:SET:TIME:DUR 500us,1ms,2ms</pre> <pre>:LSEQ:LIST:SET:TIME:DUR?</pre>

11: Input Trigger (also known as Input Trigger Type)

For a description of this parameter, see [“11: Input Trigger \(also known as Input Trigger Type\)” on page 27](#). The parameter-specific commands are described below.

SCPI Command	<p>To set the input trigger as an individual value:</p> <pre>[:SENSe] :LSEQuencer:ACQuire {1:512} :SETup:TRIGger [:INPut] IMMEDIATE VIDeo INTernal EXTernal1 EXTernal2 [:SENSe] :LSEQuencer:ACQuire {1:512} :SETup:TRIGger [:INPut] ?</pre> <p>To set the input trigger as an array:</p> <pre>[:SENSe] :LSEQuencer:LIST:SETup:TRIGger [:INPut] <enum>, <enum>, <enum>, ... [:SENSe] :LSEQuencer:LIST:SETup:TRIGger [:INPut] ?</pre> <p>The array form of the command is used to make a different setting for each acquisition in the sequence (the number of array values must match the number of acquisitions; otherwise a "settings conflict" error will occur).</p>
SCPI Examples	<pre>:LSEQ:ACQ2:SET:TRIG:INP IMM :LSEQ:ACQ2:SET:TRIG:INP? :LSEQ:LIST:SET:TRIG:INP IMM,INT,VID :LSEQ:LIST:SET:TRIG:INP?</pre>

12: Input Trigger Level

For a description of this parameter, see [“12: Input Trigger Level” on page 27](#). The parameter-specific commands are described below.

SCPI Command	<p>To set the input trigger level as an individual value:</p> <pre>[:SENSe] :LSEQuencer:ACQuire {1:512} :SETup:TRIGger [:INPut] :LEVEl <ampgt; [:SENSe] :LSEQuencer:ACQuire {1:512} :SETup:TRIGger [:INPut] :LEVEl ?</pre> <p>To set the input trigger level as an array:</p> <pre>[:SENSe] :LSEQuencer:LIST:SETup:TRIGger [:INPut] : LEVEl <ampgt;, <ampgt;, <ampgt;, ... [:SENSe] :LSEQuencer:LIST:SETup:TRIGger [:INPut] :LEVEl ?</pre> <p>The array form of the command is used to make a different setting for each acquisition in the sequence (the number of array values must match the number of acquisitions; otherwise a "settings conflict" error will occur).</p>
SCPI Examples	<pre>:LSEQ:ACQ2:SET:TRIG:INP:LEV -10dBm :LSEQ:ACQ2:SET:TRIG:INP:LEV? :LSEQ:LIST:SET:TRIG:INP:LEV 0,-10dBm,-20dBm :LSEQ:LIST:SET:TRIG:INP:LEV?</pre>

13: Input Trigger Delay

For a description of this parameter, see [“13: Input Trigger Delay” on page 27](#). The parameter-specific commands are described below.

SCPI Command	<p>To set the input trigger delay as an individual value:</p> <pre>[:SENSe] :LSEQuencer :ACQuire { 1 : 512 } :SETup :TRIGger [:INPut] :DELay <time></pre> <pre>[:SENSe] :LSEQuencer :ACQuire { 1 : 512 } :SETup :TRIGger [:INPut] :DELay?</pre> <p>To set the input trigger delay as an array:</p> <pre>[:SENSe] :LSEQuencer :LIST :SETup :TRIGger [:INPut] :DELay <time>, <time>, <time>, ...</pre> <pre>[:SENSe] :LSEQuencer :LIST :SETup :TRIGger [:INPut] :DELay?</pre>
SCPI Examples	<pre>:LSEQ:ACQ2:SET:TRIG:INP:DEL -200us :LSEQ:ACQ2:SET:TRIG:INP:DEL? :LSEQ:LIST:SET:TRIG:INP:DEL 0,-200us,-100us :LSEQ:LIST:SET:TRIG:INP:DEL?</pre>

14: Output Trigger

For a description of this parameter, see [“14: Output Trigger” on page 28](#). The parameter-specific commands are described below.

SCPI Command	<p>To set the output trigger type as an individual value:</p> <pre>[:SENSe] :LSEQuencer :ACQuire { 1 : 512 } :SETup :TRIGger :OUTPut NONE INTernal</pre> <pre>[:SENSe] :LSEQuencer :ACQuire { 1 : 512 } :SETup :TRIGger : OUTPut?</pre> <p>To set the output trigger type as an array:</p> <pre>[:SENSe] :LSEQuencer :LIST :SETup :TRIGger :OUTPut <enum>, <enum>, <enum>, ...</pre> <pre>[:SENSe] :LSEQuencer :LIST :SETup :TRIGger :OUTPut?</pre> <p>The array form of the command is used to make a different setting for each acquisition in the sequence (the number of array values must match the number of acquisitions; otherwise a "settings conflict" error will occur).</p>
SCPI Examples	<pre>:LSEQ:ACQ2:SET:TRIG:OUTP NONE :LSEQ:ACQ2:SET:TRIG:OUTP? :LSEQ:LIST:SET:TRIG:OUTP NONE,INT,NONE :LSEQ:LIST:SET:TRIG:OUTP?</pre>

15: Instrument Gain LOW Value (dB)

NOTE This sequence parameter is used by some Keysight models for which Auto Set RF Levels can be on or off. For E6650A, Auto Set RF Levels is always on, and the test set automatically selects this setting for the acquisition, so this parameter is ignored by the sequencer.

16: Multiport Adapter Input Port

NOTE This sequence parameter is used by some Keysight models which are designed to operate in connection with a Multiport Adapter. For E6650A, which does not currently support that kind of operation, this parameter is ignored by the sequencer.

17: Multiport Adapter Preamp

NOTE This sequence parameter is used by some Keysight models which are designed to operate in connection with a Multiport Adapter. For E6650A, which does not currently support that kind of operation, this parameter is ignored by the sequencer.

18: Acquisition Integration

For a description of this parameter, see [“18: Acquisition Integration” on page 29](#). The parameter-specific commands are described below.

Remote Command	<p>To set the Acquisition Integration as an individual value:</p> <pre>[:SENSe] :LSEQuencer:ACQuire { 1:512 } :SETup:INTEgration NORMal PRIMary LOWer UPPer RANGe SMIMo</pre> <pre>[:SENSe] :LSEQuencer:ACQuire { 1:512 } :SETup:INTEgration?</pre> <p>To set the Acquisition Integration as an array:</p> <pre>[:SENSe] :LSEQuencer:LIST:SETup:INTEgration <enum>, <enum>, <enum>, ...</pre> <pre>[:SENSe] :LSEQuencer:LIST:SETup:INTEgration?</pre> <p>The array form of the command is used to make a different setting for each acquisition in the sequence (the number of array values must match the number of acquisitions; otherwise a "settings conflict" error will occur).</p>
Example	<pre>:LSEQ:ACQ2:SET:INT PRIM :LSEQ:ACQ2:SET:INT? :LSEQ:LIST:SET:INT PRIM,LOW,UPP,RANG :LSEQ:LIST:SET:INT?</pre>

Sequence Setup Commands

Programming Analyzer Sequences (Parameter-Specific Commands)

19: Acquisition RF Input Port

There is no separate command for setting this parameter; see the last parameter described under **“Acquisition Parameters (Combination)” on page 116**.

Analysis Step Parameters (Parameter-Specific Commands)

Each of these commands can be used to change just one parameter of an analysis step within an acquisition.

1: Analysis Number

As analysis steps are simply numbered sequentially within the acquisition, there is no parameter-specific command for setting the number of an analysis step. However, in the commands given below, it is necessary to identify the analysis interval by number in the ASTep value.

2: Analysis Offset

For a description of this parameter, see **“2: Analysis Offset” on page 31**. The parameter-specific commands are described below.

SCPI Command	<p>To set the analysis offset as an individual value:</p> <pre>[:SENSe] :LSEQuencer :ACQuire { 1 : 512 } :ASTep { 1 : 1000 } :SETup : TIME :OFFSet <time></pre> <pre>[:SENSe] :LSEQuencer :ACQuire { 1 : 512 } :ASTep { 1 : 1000 } :SETup : TIME :OFFSet ?</pre> <p>To set the analysis offset as an array:</p> <pre>[:SENSe] :LSEQuencer :ACQuire { 1 : 512 } :LIST :SETup :TIME : OFFSet <time> , <time> , <time> , ...</pre> <pre>[:SENSe] :LSEQuencer :ACQuire { 1 : 512 } :LIST :SETup :TIME : OFFSet ?</pre> <p>The array form of the command is used to make a different setting for each analysis interval in the acquisition (the number of array values must match the number of analysis intervals; otherwise a "settings conflict" error will occur).</p>
SCPI Examples	<pre>:LSEQ:ACQ2:AST3:SET:TIME:OFFS 10ms :LSEQ:ACQ2:AST3:SET:TIME:OFFS? :LSEQ:ACQ2:LIST:SET:TIME:OFFS 500us,1ms,2ms :LSEQ:ACQ2:LIST:SET:TIME:OFFS?</pre>

Sequence Setup Commands

Programming Analyzer Sequences (Parameter-Specific Commands)

3: Analysis Interval

For a description of this parameter, see [“3: Analysis Interval” on page 31](#). The parameter-specific commands are described below.

SCPI Command	<p>To set the analysis interval as an individual value:</p> <pre>[:SENSE] :LSEQuencer :ACQuire { 1 : 512 } :ASTep { 1 : 1000 } :SETup : TIME : INTerval <time></pre> <pre>[:SENSE] :LSEQuencer :ACQuire { 1 : 512 } :ASTep { 1 : 1000 } :SETup : TIME : INTerval ?</pre> <p>To set the analysis interval as an array:</p> <pre>[:SENSE] :LSEQuencer :ACQuire { 1 : 512 } :LIST :SETup :TIME : I NTerval <time> , <time> , <time> , ...</pre> <pre>[:SENSE] :LSEQuencer :ACQuire { 1 : 512 } :LIST :SETup :TIME : INTerval ?</pre> <p>The array form of the command is used to make a different setting for each analysis interval in the acquisition (the number of array values must match the number of analysis intervals; otherwise a "settings conflict" error will occur).</p>
SCPI Examples	<pre>:LSEQ:ACQ2:AST3:SET:TIME:INT 10ms :LSEQ:ACQ2:AST3:SET:TIME:INT? :LSEQ:ACQ2:LIST:SET:TIME:INT 500us,1ms,2ms :LSEQ:ACQ2:LIST:SET:TIME:INT?</pre>

4: Measurement Bitmap

For a description of this parameter, see [“4: Measurement Bitmap” on page 32](#). The parameter-specific commands are described below.

SCPI Command	<p>To set the measurement bitmap as an individual value:</p> <pre>[:SENSE] :LSEQuencer :ACQuire { 1 : 512 } :ASTep { 1 : 1000 } :SETup : MBitMap <Integer></pre> <pre>[:SENSE] :LSEQuencer :ACQuire { 1 : 512 } :ASTep { 1 : 1000 } :SETup : MBitMap ?</pre> <p>To set the measurement bitmap as an array:</p> <pre>[:SENSE] :LSEQuencer :ACQuire { 1 : 512 } :LIST :SETup :MBitMap <Integer> , <Integer> , <Integer> , ...</pre> <pre>[:SENSE] :LSEQuencer :ACQuire { 1 : 512 } :LIST :SETup :MBitMap ?</pre> <p>The array form of the command is used to make a different setting for each analysis interval in the acquisition (the number of array values must match the number of analysis intervals; otherwise a "settings conflict" error will occur).</p>
SCPI Examples	<pre>:LSEQ:ACQ2:SET:MPA:MBIT 1 :LSEQ:ACQ2:SET:MPA:MBIT? :LSEQ:LIST:SET:MPA:MBIT 1,256,1032 :LSEQ:LIST:SET:MPA:MBIT?</pre>

5: Expected Power at DUT Output

For a description of this parameter, see **“5: Expected Power at DUT Output” on page 34**. The parameter-specific commands are described below.

<p>SCPI Command</p>	<p>To set the expected power as an individual value:</p> <pre>[:SENSe] :LSEQuencer :ACQuire { 1 : 512 } :ASTep { 1 : 1000 } :SETup : EPOWer < amp ></pre> <pre>[:SENSe] :LSEQuencer :ACQuire { 1 : 512 } :ASTep { 1 : 1000 } :SETup : EPOWer ?</pre> <p>To set the expected power as an array:</p> <pre>[:SENSe] :LSEQuencer :ACQuire { 1 : 512 } :LIST :SETup :EPOWer < amp > , < amp > , < amp > , ...</pre> <pre>[:SENSe] :LSEQuencer :ACQuire { 1 : 512 } :LIST :SETup :EPOWer ?</pre> <p>The array form of the command is used to make a different setting for each analysis interval in the acquisition (the number of array values must match the number of analysis intervals; otherwise a "settings conflict" error will occur).</p>
<p>SCPI Examples</p>	<pre>:LSEQ:ACQ2:SET:MPA:EPOW 20dBm :LSEQ:ACQ2:SET:MPA:EPOW? :LSEQ:LIST:SET:MPA:EPOW 0,20dBm,10dBm :LSEQ:LIST:SET:MPA:EPOW?</pre>

Sequence Setup Commands

Programming Source Sequences (Combination Command)

Programming Source Sequences (Combination Command)

The 11 parameters for a source sequence can be set as a group, using a command which combines all these parameters, or independently, using a set of parameter-specific commands. The combination command is shown below.

Remote Command:	<pre>:SOURCE:LIST:STEP[1] 2 3 4..1000:SETup IMMediate INTernal KEY BUS EXternal2, <time>, NONE PGSM EGSM RGSM DCS1800 PCS1900 TGSM810 GSM450 GSM480 GSM700 GSM850 BANDI BANDII BANDIII BANDIV BANDV BANDVI BANDVII BANDVIII BANDIX BANDX BANDXI BANDXII BANDXIII BANDXIV USCELL USPCS JAPAN KOREAN NMT IMT2K UPPER SECOND PAMR400 PAMR800 IMTEXT PCS1DOT9G AWS US2DOT5G PUBLIC LOWER NONE BAND1 BAND2 BAND3 BAND4 BAND5 BAND6 BAND7 BAND8 BAND10 BAND11 BAND12 BAND13 BAND14 BAND17 BAND18 BAND19 BAND20 BAND21 BAND24 BAND25 BAND26 BAND27 BAND28 BAND31 BAND33 BAND34 BAND35 BAND36 BAND37 BAND38 BAND39 BAND40 BAND41 BAND42 BAND43 BAND44 BANDA BANDB BANDC BANDD BANDE BANDF, DOWN UP, <freq>, <ampl>, <string>, TIME COUNT CONTinuous, <time>, ON OFF 1 0, [<int>], :SOURce:LIST:STEP[1] 2 3 4..1000:SETup?</pre>
Example:	<pre>:SOUR:LIST:STEP1:SET INT, 1ms, PGSM, DOWN, 10, -25 dBm, "GSM_Test1.bin", TIME, 10ms, OFF, 255</pre>

Notes:	<p>The parameters are: (There is a total of 11 items in each step, the following is a list of the items in the order they must appear in the remote command.)</p> <ol style="list-style-type: none"> 1. Step Trigger <enum> - specifies the input trigger for the step. 2. Transition Time <time> - specifies the transition time for the step in seconds. 3. Radio Band <enum> - specifies the radio band for the step. 4. Radio Band Link <enum> - specifies the radio band link direction for the step. 5. Frequency/Channel Number <freq>/<chan num> - specifies the frequency in Hz or the channel number for the step. The channel number and frequency are combined as one parameter that represents the frequency or channel number depending on the radio band setting. If the radio band is set to NONE, this value is interpreted as a frequency value in Hz. If the radio band is set to a valid band, this value is interpreted as a channel number. 6. Power <ampl> - specifies the output power for the step in dBm. 7. Waveform <string> - specifies the waveform for playback during the step. The step can output either a new ARB waveform, continue playback of the previous waveform, or output a CW tone. The options for specifying these are: <filename> - plays the specified waveform from the start. The filename value is the name of the file within ARB playback memory, it does not include the windows path to the file on the HDD. If you enter a filename for a waveform that does not reside within ARB playback memory, an error is generated. CONT - continues playback of the ARB file from the previous step CW - outputs a CW tone OFF - disable RF output 8. Step Duration <enum> - specifies the duration of the step. The duration can be specified to be either time, or play count of the ARB file associated with the step, or continuous. If Waveform is set to "CW", this value cannot be set to Play Count and an error will be generated. If continuous is selected, the following Time or Count value is ignored. 9. Time or Count <time/int> - specifies time duration in seconds or play count of the ARB file associated with the step. 10. Output Trigger <Boolean> - specifies the output trigger for the step.
--------	---

Programming Source Sequences (Parameter-Specific Commands)

Each of these commands can be used to change just one parameter of a source step within a sequence.

1: Step Number

As source steps are simply numbered sequentially within the sequence, there is no parameter-specific command for setting the number of a source step. However, in the commands given below, it is necessary to identify the source step by number in the STEP value.

2: Step Trigger

For a description of this parameter, see [“2: Step Trigger” on page 37](#). The parameter-specific commands are described below.

Remote Command:	:SOURce:LIST:STEP [1] 2 3...1000:SETup:INPut:TRIGger IMMediate INTernal EXTernal2 KEY BUS :SOURce:LIST:STEP [1] 2 3...1000:SETup:INPut:TRIGger?
Example:	:SOUR:LIST:STEP2:SET:INP:TRIG BUS :SOUR:LIST:STEP2:SET:INP:TRIG?

3: Transition Time (also known as Setup Time)

For a description of this parameter, see [“3: Transition Time \(also known as Setup Time\)” on page 37](#). The parameter-specific commands are described below.

Remote Command:	:SOURce:LIST:STEP [1] 2 3...1000:SETup:TRANSition:TIME <time> :SOURce:LIST:STEP [1] 2 3...1000:SETup:TRANSition:TIME?
Example:	:SOUR:LIST:STEP2:SET:TRAN:TIME 1ms :SOUR:LIST:STEP2:SET:TRAN:TIME?

4: Radio Band

For a description of this parameter, see **“4: Radio Band” on page 38**. The parameter-specific commands are described below.

Remote Command:	<pre>:SOURCE:LIST:STEP [1] 2 3...1000:SETup:RADio: BAND NONE PGSM EGSM RGSM DCS1800 PCS1900 TGSM810 GSM450 GSM480 GSM700 GSM850 BANDI BANDII BANDIII BANDIV BANDV BANDVI BANDVII BANDVIII BANDIX BANDX BANDXI BANDXII BANDXIII BANDXIV USCELL USPCS JAPAN KOREAN NMT IMT2K UPPER SECOND PAMR400 PAMR800 IMTEXT PCS1DOT9G AWS US2DOT5G PUBLIC LOWER NONE BAND1 BAND2 BAND3 BAND4 BAND5 BAND6 BAND7 BAND8 BAND10 BAND11 BAND12 BAND13 BAND14 BAND17 BAND18 BAND19 BAND20 BAND21 BAND24 BAND25 BAND26 BAND27 BAND28 BAND31 BAND33 BAND34 BAND35 BAND36 BAND37 BAND38 BAND39 BAND40 BAND41 BAND42 BAND43 BAND44 BANDA BANDB BANDC BANDD BANDE BANDF :SOURCE:LIST:STEP [1] 2 3...1000:SETup:RADio: BAND?</pre>
Example:	<pre>:SOUR:LIST:STEP2:SET:RAD:BAND PGSM :SOUR:LIST:STEP2:SET:RAD:BAND?</pre>

5: Radio Band Link

For a description of this parameter, see **“5: Radio Band Link” on page 38**. The parameter-specific commands are described below.

Remote Command:	<pre>:SOURCE:LIST:STEP [1] 2 3...1000:SETup:RADio: BAND: LINK DOWN UP :SOURCE:LIST:STEP [1] 2 3...1000:SETup:RADio: BAND: LINK?</pre>
Example:	<pre>:SOUR:LIST:STEP2:SET:RAD:BAND:LINK DOWN :SOUR:LIST:STEP2:SET:RAD:BAND:LINK?</pre>

6: Frequency/Channel

For a description of this parameter, see **“6: Frequency/Channel” on page 39**. The parameter-specific commands are described below.

Remote Command:	<pre>:SOURCE:LIST:STEP [1] 2 3...1000:SETup:CNFRequency <double> :SOURCE:LIST:STEP [1] 2 3...1000:SETup:CNFRequency?</pre>
Example:	<pre>:SOUR:LIST:STEP2:SET:CNFR 1GHz :SOUR:LIST:STEP2:SET:CNFR 124 :SOUR:LIST:STEP2:SET:CNFR?</pre>

Sequence Setup Commands

Programming Source Sequences (Parameter-Specific Commands)

7: Power

For a description of this parameter, see [“7: Power” on page 39](#). The parameter-specific commands are described below.

Remote Command:	<code>:SOURce:LIST:STEP [1] 2 3...1000:SETup:AMPLitude <double></code> <code>:SOURce:LIST:STEP [1] 2 3...1000:SETup:AMPLitude?</code>
Example:	<code>:SOUR:LIST:STEP2:SET:AMPL -50dBm</code> <code>:SOUR:LIST:STEP2:SET:AMPL?</code>

8: Waveform

For a description of this parameter, see [“8: Waveform” on page 39](#). The parameter-specific commands are described below.

Remote Command:	<code>:SOURce:LIST:STEP [1] 2 3...1000:SETup:WAVEform <string></code> <code>:SOURce:LIST:STEP [1] 2 3...1000:SETup:WAVEform?</code>
Example:	<code>:SOUR:LIST:STEP2:SET:WAV “CW”</code> <code>:SOUR:LIST:STEP2:SET:WAV?</code>

9: Step Duration

For a description of this parameter, see [“9: Step Duration” on page 39](#). The parameter-specific commands are described below.

Remote Command:	<code>:SOURce:LIST:STEP [1] 2 3...1000:SETup:DURation:TYPE</code> <code>TIME COUNT CONTinuous</code> <code>:SOURce:LIST:STEP [1] 2 3...1000:SETup:DURation:TYPE?</code>
Example:	<code>:SOUR:LIST:STEP2:SET:DUR:TYPE TIME</code> <code>:SOUR:LIST:STEP2:SET:DUR:TYPE?</code>

10: Time / Count

For a description of this parameter, see [“10: Time / Count” on page 40](#). The parameter-specific commands are described below.

Remote Command:	<code>:SOURce:LIST:STEP [1] 2 3...1000:SETup:DURation:TCOUNT</code> <code><double></code> <code>:SOURce:LIST:STEP [1] 2 3...1000:SETup:DURation:TCOUNT?</code>
Example:	<code>:SOUR:LIST:STEP2:SET:DUR:TCO 1s</code> <code>:SOUR:LIST:STEP2:SET:DUR:TCO 10</code> <code>:SOUR:LIST:STEP2:SET:DUR:TCO?</code>

11: Output Trigger

For a description of this parameter, see **“11: Output Trigger” on page 40**. The parameter-specific commands are described below.

Remote Command:	<pre>:SOURce:LIST:STEP [1] 2 3...1000:SETup:OUTPut:TRIGger ON OFF 1 0 :SOURce:LIST:STEP [1] 2 3...1000:SETup:OUTPut:TRIGger</pre>
Example:	<pre>:SOUR:LIST:STEP2:SET:OUTP:TRIG ON :SOUR:LIST:STEP2:SET:OUTP:TRIG?</pre>

Sequence Setup Commands
Programming Source Sequences (Parameter-Specific Commands)

10 Programming a Sequence

This chapter provides you with a step-by-step how to program the test set to set up a GSM/EDGE Sequence, run the Sequence to acquire data and then retrieve the results, using the SCPI remote control commands. From this example you can go on to build your own Sequence to capture and measure data from your mobile device.

- [Sequence Programming Example](#)

Sequence Programming Example

The example used in this chapter uses the GSM radio standard. GSM/EDGE measurements can be made in the Sequence Analyzer mode only if you have the GSM/EDGE measurement application licensed in the test set. The SCPI commands for setting each of the GSM/EDGE measurements from inside the Sequence Analyzer mode are listed in [Chapter 13](#). Changes to these parameters made from within the Sequence Analyzer mode result in changes to the equivalent parameters in the measurement mode.

The sample sequence, shown in [Figure 10-1](#), shows a simple sequence that can be used to calibrate a mobile device. It consists of four sets of stepped power sequences, using PGSM and EGSM radio standards. This section shows you how to build up a program to set the test set up to acquire this data and provide measurement results. Some of the parameters in the program are set to example values which you would modify as needed.

The calibration sequence is shown in [Figure 10-1](#) and the associated spreadsheet is shown in [Figure 10-2](#). To allow the test set to make measurements the sequence is divided up into four acquisitions, and in each acquisition there are 15 analysis intervals. From the spreadsheet you can see that the Measurement Bitmap value of 10011 sets the test set up to perform the measurements of Basic Transmit Power, Basic Frequency and Phase, and EDGE Power Vs. Time.

Figure 10-1 Calibration sequence

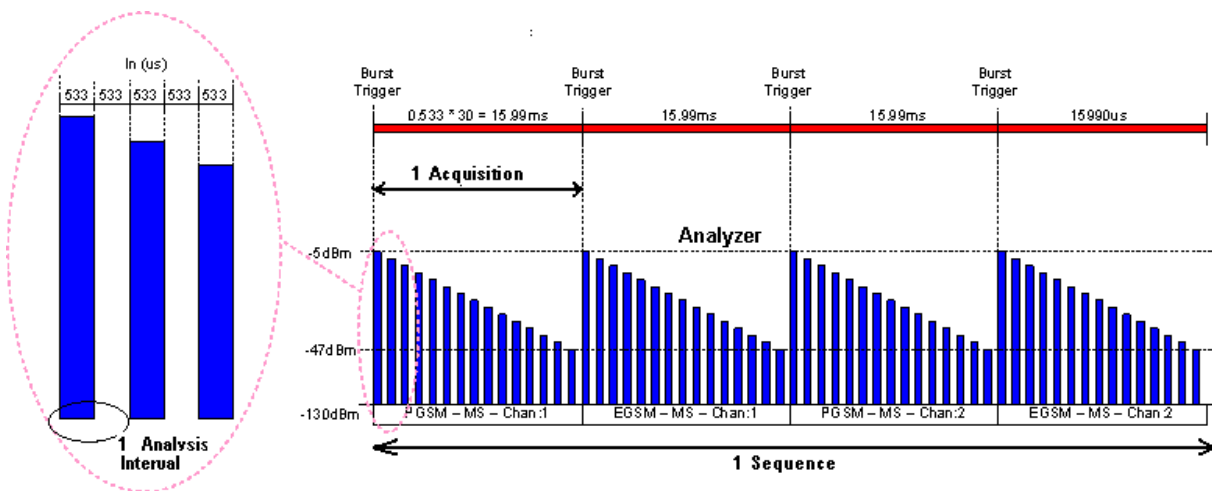

Figure 10-2 Calibration sequence spreadsheet

Acq Number	Radio Standard	Radio Band	Device	Freq(MHz)	Ch. Chan	Number of Averages	Peak Power(dBm)	Intr Gain Type	Transition Time(ms)	Acquisition Duration(ms)	Input Trigger Type	Input Trigger Level	Input Trigger Delay(ms)	Acquisition Output Trigger	Intr Gain LOV value(dB)	Analysis Step Number	Analysis Step Offset(ms)	Step Interval (ms)	Measurement Bias	DLT Output (dBm)
1	GSM	PGSM	MS	1	1	0	LOW	0.2	15.99	VIDeo	-10	0	NONE	-20						
																1	0	0.533	10101	-5
																2	1.066	0.533	10101	-8
																3	2.132	0.533	10101	-11
																4	3.198	0.533	10101	-14
																5	4.264	0.533	10101	-17
																6	5.33	0.533	10101	-20
																7	6.396	0.533	10101	-23
																8	7.462	0.533	10101	-26
																9	8.528	0.533	10101	-29
																10	9.594	0.533	10101	-32
																11	10.66	0.533	10101	-35
																12	11.726	0.533	10101	-38
																13	12.792	0.533	10101	-41
																14	13.858	0.533	10101	-44
																15	14.924	0.533	10101	-47
2	GSM	EGSM	MS	1	1	0	LOW	0.2	15.99	VIDeo	-10	0	NONE	-20						
																1	0	0.533	10101	-5
																2	1.066	0.533	10101	-8
																3	2.132	0.533	10101	-11
																4	3.198	0.533	10101	-14
																5	4.264	0.533	10101	-17
																6	5.33	0.533	10101	-20
																7	6.396	0.533	10101	-23
																8	7.462	0.533	10101	-26
																9	8.528	0.533	10101	-29
																10	9.594	0.533	10101	-32
																11	10.66	0.533	10101	-35
																12	11.726	0.533	10101	-38
																13	12.792	0.533	10101	-41
																14	13.858	0.533	10101	-44
																15	14.924	0.533	10101	-47
3	GSM	PGSM	MS	2	1	0	LOW	0.2	15.99	VIDeo	-10	0	NONE	-20						
																1	0	0.533	10101	-5
																2	1.066	0.533	10101	-8
																3	2.132	0.533	10101	-11
																4	3.198	0.533	10101	-14

To set up the program use the following series of steps

- Set up the test set attenuation
- Set up the RF input and output ports
- Define the measurement parameters
- Define the number of acquisitions
- Define the number of analysis intervals
- Set up the input trigger
- Set up the List Sequencer measurement parameters
- Use one command for first acquisition 1 setup
- Use one command for first analysis interval setup
- Get the results

Programming a Sequence

Sequence Programming Example

Set up the test set attenuation

Set up 20dB of mechanical attenuation; this is fixed for whole Sequence:

```
:SENSe:LSEQuencer:POWer:RF:ATTenuation 20
```

Set up the RF input and output ports

In this example use the RF I/O 1 port as both input and output:

```
:SENSe:FEED:RF:PORT[:INPut] RFIO1
```

```
:SENSe:FEED:RF:PORT:OUTPut RFIO1
```

Set up the List Sequencer measurement parameters

Set trigger timeout:

```
:SENSe:LSEQuencer:TIMEout:TRIGger 2 s
```

Set include source in sequence; for this example the source is not included in the sequence:

```
:SENSe:LSEQuencer:INCLude:SOURce 0
```

Set Abort on Limit Fail to ON:

```
:SENSe:LSEQuencer:ABORT:LIMit:FAIL:STATe ON
```

Set the Abort on Error parameter to ON:

```
:SENSe:LSEQuencer:ABORT:ERRor:STATe ON
```

Set up the input trigger

The input trigger is set for each acquisition (below), but set the trigger polarity for the duration of a sequence as follows (in the case of the EXTERNAL1 and EXTERNAL2 triggers, set the level as well):

```
:TRIGger:LSEQuencer:VIDeo:SLOPe POSitive
```

```
:TRIGger:LSEQuencer:EXTernal1:SLOPe POSitive|NEGative:
```

```
:TRIGger:LSEQuencer:EXTernal1:LEVel <level>
```

```
:TRIGger:LSEQuencer:EXTernal2:SLOPe POSitive|NEGative:
```

```
:TRIGger:LSEQuencer:EXTernal2:LEVel <level>
```

Define the measurement parameters

The measurements that need to be set up are Basic Transmit Power, Basic Frequency and GSMK PVT.

Basic Transmit Power

The Basic Transmit Power measurement parameters are listed in [“Basic Transmit Power” on page 178](#).

For this example the following commands are used to set up the Basic Transmit Power measurement (the digital IF bandwidth, the filter type, and the upper and lower limits for the test):

```
:SENSe:LSEQuencer:BTXPower:GSM:DIF:BANDwidth:RESolution 40 MHz
:SENSe:LSEQuencer:BTXPower:GSM:DIF:FILTEr:TYPE FLATtop
:SENSe:LSEQuencer:BTXPower:LIMit:UPPer 9
:SENSe:LSEQuencer:BTXPower:LIMit:LOWer -10
```

Basic Frequency and Phase Error

For this example the following commands are used to set up the Basic Frequency and Phase Error measurement (the digital IF bandwidth and frequency error limit for the test):

For this example, the following command sets up the Info BW parameter:

```
:SENSe:LSEQuencer:BFERor:DIF:BANDwidth:RESolution 40 MHz
:SENSe:LSEQuencer:BFERor:LIMit:PPM 100
```

EDGE PVT

To set up the EDGE PVT measurement see the list of SCPI commands in [“EDGE Power vs. Time \(PvT\)” on page 193](#) and select the ones that you want to define, using the List Sequencer SCPI variation of the commands.

Define the number of acquisitions

There are four Acquisitions in this Sequence:

```
:SENSe:LSEQuencer:NUMBer:ACQuisition 4
```

Define the number of analysis intervals

There are 15 Analysis Intervals per Acquisition in this Sequence:

```
:SENSe:LSEQuencer:ACQuire1:NUMBer:ASTeps 15
```

Use one command for first acquisition 1 setup

You can use one command to set up all the Acquisition parameters as follows:

```
:SENSe:LSEQuencer:ACQuire1:SETup
GSM, PGSM, MS, 1, 1, 0, LOW, 0.2ms, 15.99ms, VIDEo, -10, 0, NONE, -20
```

which sets up Acquisition 1 with the following

- Radio standard: GSM
- Radio band: PGSM
- Device type: mobile station
- Channel number: 1
- Number of averages: 1

Programming a Sequence

Sequence Programming Example

- Peak power: dB
- Instrument gain type: LOW
- Transition time: 0.2 ms
- Acquisition duration: 15.99 ms
- Input trigger type: Video
- Input trigger level: -10 dB
- Input trigger delay: 0 ms
- Output trigger: NONE
- Instrument gain "LOW" value: -20 dB

Use one command for first analysis interval setup

You can use one command to set up the analysis interval parameters as follows:

```
:SENSe:LSEQuencer:ACQuire1:ASTep1:SETup 0ms,0.533ms,19,-5
```

which sets up Analysis Interval 1 with the following

- Analysis step offset: 0 ms
- Analysis step interval: 533 ms
- Measurement bitmap: 19 (equivalent to binary 10011), which gives results for the following measurements:
 - Basic Transmit Power
 - Basic Frequency and Phase
 - EDGE Power vs. Time
- Expected power at the DUT output: -5 dB

The program for the first 15 intervals of Acquisition 1 is as follows

```
:SENSe:LSEQuencer:ACQuire1:ASStep1:SETup 0ms,0.533ms,19,-5
:SENSe:LSEQuencer:ACQuire1:ASStep2:SETup 1.066ms,0.533ms,19,-8
:SENSe:LSEQuencer:ACQuire1:ASStep3:SETup 2.132ms,0.533ms,19,-11
:SENSe:LSEQuencer:ACQuire1:ASStep4:SETup 3.198ms,0.533ms,19,-14
:SENSe:LSEQuencer:ACQuire1:ASStep5:SETup 4.264ms,0.533ms,19,-17
:SENSe:LSEQuencer:ACQuire1:ASStep6:SETup 5.33ms,0.533ms,19,-20
:SENSe:LSEQuencer:ACQuire1:ASStep7:SETup 6.396ms,0.533ms,19,-23
:SENSe:LSEQuencer:ACQuire1:ASStep8:SETup 7.462ms,0.533ms,19,-26
:SENSe:LSEQuencer:ACQuire1:ASStep9:SETup 8.528ms,0.533ms,19,-29
:SENSe:LSEQuencer:ACQuire1:ASStep10:SETup 9.594ms,0.533ms,19,-32
:SENSe:LSEQuencer:ACQuire1:ASStep11:SETup 10.66ms,0.533ms,19,-35
:SENSe:LSEQuencer:ACQuire1:ASStep12:SETup 11.726ms,0.533ms,19,-38
:SENSe:LSEQuencer:ACQuire1:ASStep13:SETup 12.792ms,0.533ms,19,-41
:SENSe:LSEQuencer:ACQuire1:ASStep14:SETup 13.858ms,0.533ms,19,-44
:SENSe:LSEQuencer:ACQuire1:ASStep15:SETup 14.924ms,0.533ms,19,-47
```

These program steps are duplicated for each Acquisition, replacing the Acquisition number appropriately.

So, for Acquisition 2, the Acquisition setup is

```
:SENSe:LSEQuencer:ACQuire2:SETup
GSM,EGSM,MS,1,1,0,LOW,0.2ms,15.99ms,VIDeo,-10,0,NONE,-20
```

with previous steps repeated, but with Acquisition 2 specified:

```
:SENSe:LSEQuencer:ACQuire2:ASStep1:SETup 0ms,0.533ms,19,-5
:SENSe:LSEQuencer:ACQuire2:ASStep2:SETup 1.066ms,0.533ms,19,-8
:SENSe:LSEQuencer:ACQuire2:ASStep3:SETup 2.132ms,0.533ms,19,-11
:SENSe:LSEQuencer:ACQuire2:ASStep4:SETup 3.198ms,0.533ms,19,-14
:SENSe:LSEQuencer:ACQuire2:ASStep5:SETup 4.264ms,0.533ms,19,-17
:SENSe:LSEQuencer:ACQuire2:ASStep6:SETup 5.33ms,0.533ms,19,-20
:SENSe:LSEQuencer:ACQuire2:ASStep7:SETup 6.396ms,0.533ms,19,-23
:SENSe:LSEQuencer:ACQuire2:ASStep8:SETup 7.462ms,0.533ms,19,-26
:SENSe:LSEQuencer:ACQuire2:ASStep9:SETup 8.528ms,0.533ms,19,-29
:SENSe:LSEQuencer:ACQuire2:ASStep10:SETup 9.594ms,0.533ms,19,-32
```

Programming a Sequence

Sequence Programming Example

```
:SENSe:LSEQuencer:ACQUire2:ASTep11:SETup 10.66ms,0.533ms,19,-35
:SENSe:LSEQuencer:ACQUire2:ASTep12:SETup 11.726ms,0.533ms,19,-38
:SENSe:LSEQuencer:ACQUire2:ASTep13:SETup 12.792ms,0.533ms,19,-41
:SENSe:LSEQuencer:ACQUire2:ASTep14:SETup 13.858ms,0.533ms,19,-44
:SENSe:LSEQuencer:ACQUire2:ASTep15:SETup 14.924ms,0.533ms,19,-47
```

For Acquisition 3 the Acquisition setup is

```
:SENSe:LSEQuencer:ACQUire3:SETup
GSM,PGSM,MS,2,1,0,LOW,0.2ms,15.99ms,VIDeo,-10,0,NONE,-20
```

with previous steps repeated, this time with Acquisition 3 specified:

```
:SENSe:LSEQuencer:ACQUire3:ASTep1:SETup 0ms,0.533ms,19,-5
:SENSe:LSEQuencer:ACQUire3:ASTep2:SETup 1.066ms,0.533ms,19,-8
:SENSe:LSEQuencer:ACQUire3:ASTep3:SETup 2.132ms,0.533ms,19,-11
:SENSe:LSEQuencer:ACQUire3:ASTep4:SETup 3.198ms,0.533ms,19,-14
:SENSe:LSEQuencer:ACQUire3:ASTep5:SETup 4.264ms,0.533ms,19,-17
:SENSe:LSEQuencer:ACQUire3:ASTep6:SETup 5.33ms,0.533ms,19,-20
:SENSe:LSEQuencer:ACQUire3:ASTep7:SETup 6.396ms,0.533ms,19,-23
:SENSe:LSEQuencer:ACQUire3:ASTep8:SETup 7.462ms,0.533ms,19,-26
:SENSe:LSEQuencer:ACQUire3:ASTep9:SETup 8.528ms,0.533ms,19,-29
:SENSe:LSEQuencer:ACQUire3:ASTep10:SETup 9.594ms,0.533ms,19,-32
:SENSe:LSEQuencer:ACQUire3:ASTep11:SETup 10.66ms,0.533ms,19,-35
:SENSe:LSEQuencer:ACQUire3:ASTep12:SETup 11.726ms,0.533ms,19,-38
:SENSe:LSEQuencer:ACQUire3:ASTep13:SETup 12.792ms,0.533ms,19,-41
:SENSe:LSEQuencer:ACQUire3:ASTep14:SETup 13.858ms,0.533ms,19,-44
:SENSe:LSEQuencer:ACQUire3:ASTep15:SETup 14.924ms,0.533ms,19,-47
```

And finally, the fourth Acquisition is set up as follows:

```
:SENSe:LSEQuencer:ACQUire4:SETup
GSM,EGSM,MS,2,1,0,LOW,0.2ms,15.99ms,VIDeo,-10,0,NONE,-20
```

with the previous analysis steps repeated but with Acquisition 4 specified:

```
:SENSe:LSEQuencer:ACQUire4:ASTep1:SETup 0ms,0.533ms,19,-5
:SENSe:LSEQuencer:ACQUire4:ASTep2:SETup 1.066ms,0.533ms,19,-8
:SENSe:LSEQuencer:ACQUire4:ASTep3:SETup 2.132ms,0.533ms,19,-11
:SENSe:LSEQuencer:ACQUire4:ASTep4:SETup 3.198ms,0.533ms,19,-14
:SENSe:LSEQuencer:ACQUire4:ASTep5:SETup 4.264ms,0.533ms,19,-17
```

```
:SENSe:LSEQuencer:ACQUire4:ASTep6:SETup 5.33ms,0.533ms,19,-20  
:SENSe:LSEQuencer:ACQUire4:ASTep7:SETup 6.396ms,0.533ms,19,-23  
:SENSe:LSEQuencer:ACQUire4:ASTep8:SETup 7.462ms,0.533ms,19,-26  
:SENSe:LSEQuencer:ACQUire4:ASTep9:SETup 8.528ms,0.533ms,19,-29  
:SENSe:LSEQuencer:ACQUire4:ASTep10:SETup 9.594ms,0.533ms,19,-32  
:SENSe:LSEQuencer:ACQUire4:ASTep11:SETup 10.66ms,0.533ms,19,-35  
:SENSe:LSEQuencer:ACQUire4:ASTep12:SETup 11.726ms,0.533ms,19,-38  
:SENSe:LSEQuencer:ACQUire4:ASTep13:SETup 12.792ms,0.533ms,19,-41  
:SENSe:LSEQuencer:ACQUire4:ASTep14:SETup 13.858ms,0.533ms,19,-44  
:SENSe:LSEQuencer:ACQUire4:ASTep15:SETup 14.924ms,0.533ms,19,-47
```

Get the results

Measurement results can be obtained using the `FETCh` and `READ` commands, as described in [“Results by SCPI” on page 109](#).

Programming a Sequence
Sequence Programming Example

11 Example Test Scenarios

This chapter provides some basic examples of non-signaling tests performed in the Sequence Analyzer mode.

The chapter topics are:

- **Non-Signaling Test Requirements**
- **Calibration Example**
- **Verification Example**

Non-Signaling Test Requirements

The EXF test set is generally used in a non-signaling test environment, in which the cellular mobile device under test does not engage in actual call-processing with a base station or base-station emulator.

In the absence of call-processing, the mobile device must be tested by other means. Although the requirements of non-signaling test vary greatly from one device to another, they include at least some combination of the following elements:

- Test modes designed into the DUT itself, and activated either by commands from a PC controller or by an RF stimulus from the test set.
- Proprietary software tools created by the maker of the mobile device, for the purpose of communicating with the DUT from a PC controller and activating whatever device functions are required during a test.
- An RF stimulus applied by the test set to the DUT, using an ARB waveform file that includes any encoding (synchronization channels, for example) which the DUT must receive during testing. Although the test set is not a base-station emulator, the RF stimulus it provides can mimic the expected input from a base station to a sufficient degree to support testing of this kind.
- Software tools (such as Keysight Signal Studio) for creating ARB waveforms which the test set will play during testing.
- Signal analysis of the RF output from the DUT, including a wide variety of measurements and radio formats (all of which can be included within one test sequence).
- Time-coordination between the test set's stimulus and measurement operations and the DUT's transmit and receive operations (this is accomplished by configuring the test sequence).
- Software tools (such as Keysight Sequence Studio) for creating a test sequence and aligning its steps with a measured signal.

Because mobile devices (and modes on the same device) differ so greatly, setting up a non-signaling test requires very detailed knowledge of that device's characteristics and test requirements. Such information is not only device-specific, it is also the private intellectual property of the device manufacturer, and cannot easily be shared here. For that reason, it will be necessary to present test examples somewhat generically, with identifying details omitted.

Calibration Example

In this example, the built-in test functions of the DUT are used to implement an FTD (fast device tune) calibration sequence for mobile phone in cdma2000 mode.

The hardware setup is illustrated below. The PC controller communicates with the DUT and with the EXF test set by way of USB cables. RF signals are exchanged bi-directionally between the DUT's C2K antenna port and the test set's RFIO 1 port.

Figure 11-1 Hardware Setup for Calibration Example



Example Test Scenarios

Calibration Example

The maker of the mobile device has created an application for running the device from a controller; this tool is used to configure, operate, and calibrate the DUT.

By means of this application, the DUT is commanded to transmit an uplink signal for a series of 16 channels (and to step through 5 power levels for each channel). The test set measures the 5 RF power levels at each uplink frequency, so that this test data can be used to create calibration factors which are stored in the DUT and later used to adjust its transmit level at different frequencies.

Table 11-1 Uplink and Downlink Frequencies

#	Channel	Uplink Freq	Downlink Freq
1	1013	824.7	869.7
2	46	826.38	871.38
3	98	827.94	872.94
4	150	829.5	874.5
5	202	831.06	876.06
6	254	832.62	877.62
7	306	834.18	879.18
8	358	835.74	880.74
9	410	837.3	882.3
10	462	838.86	883.86
11	514	840.42	885.42
12	566	841.98	886.98
13	618	843.54	888.54
14	670	845.1	890.1
15	722	846.66	891.66
16	779	848.37	893.37

Because a frequency change cannot occur during an acquisition, the sequence needs to include 16 separate acquisitions (one for each channel). The 5 descending power levels which the DUT transmits on each channel have a duration of 20 ms; therefore, a 100 ms interval needs to be set aside for each channel. (However, the acquisitions will each be shortened to 95 ms, so that there is a brief gap to arm the trigger for the next acquisition.)

Figure 11-2 The First 2 of 16 Channel Outputs from DUT

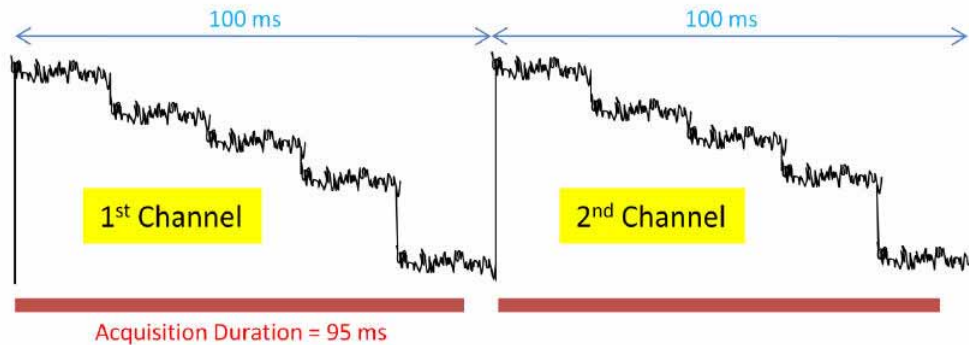

Once the DUT has been commanded to begin sending out the uplink signals, we can use the Sequence Studio application to create a sequence. We begin by creating a single acquisition, with the frequency set to 824.7 MHz (the uplink frequency for the first channel), and the acquisition set up to trigger on the RF burst from the DUT. By downloading this simple sequence to the test set and reading back the sequence trace from the test set, we obtain a graphical display of the uplink signal and its 5 descending levels.

Figure 11-3 The First of 16 Acquisitions in the Sequence

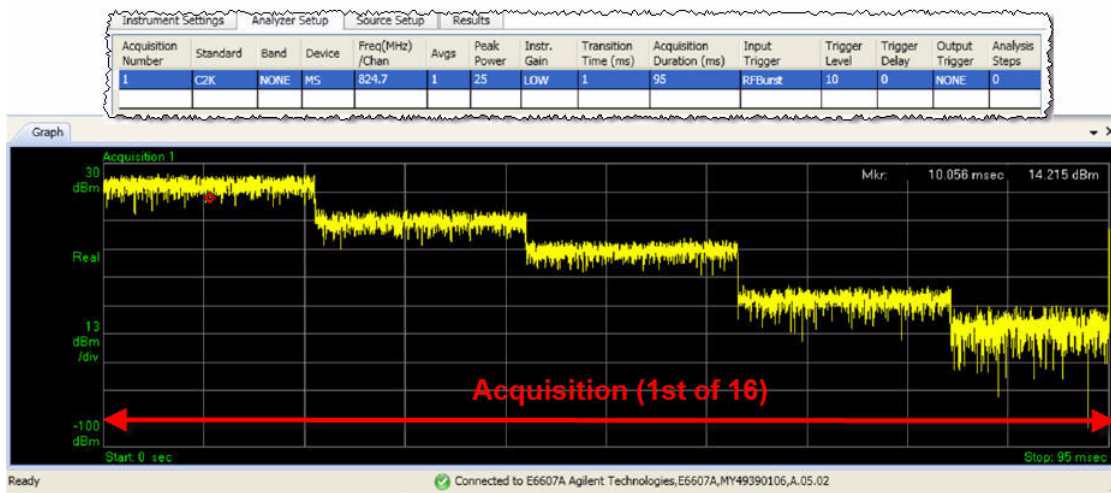

Example Test Scenarios

Calibration Example

We then use Sequence Studio to add 5 analysis intervals to the acquisition, which appear on the graph as 5 blue bars. The bars can be positioned on the screen, both horizontally (to specify the timing and duration of the interval of measurement) and vertically (to specify the expected power level during that interval, so that there is a reference for pass/fail power results). For each interval, a separate combination of measurements can be selected. In this case, Basic Tx Power is selected for each interval, as that is the type of result needed for the calibration procedure.

Figure 11-4 Analysis Intervals Added to the Acquisition

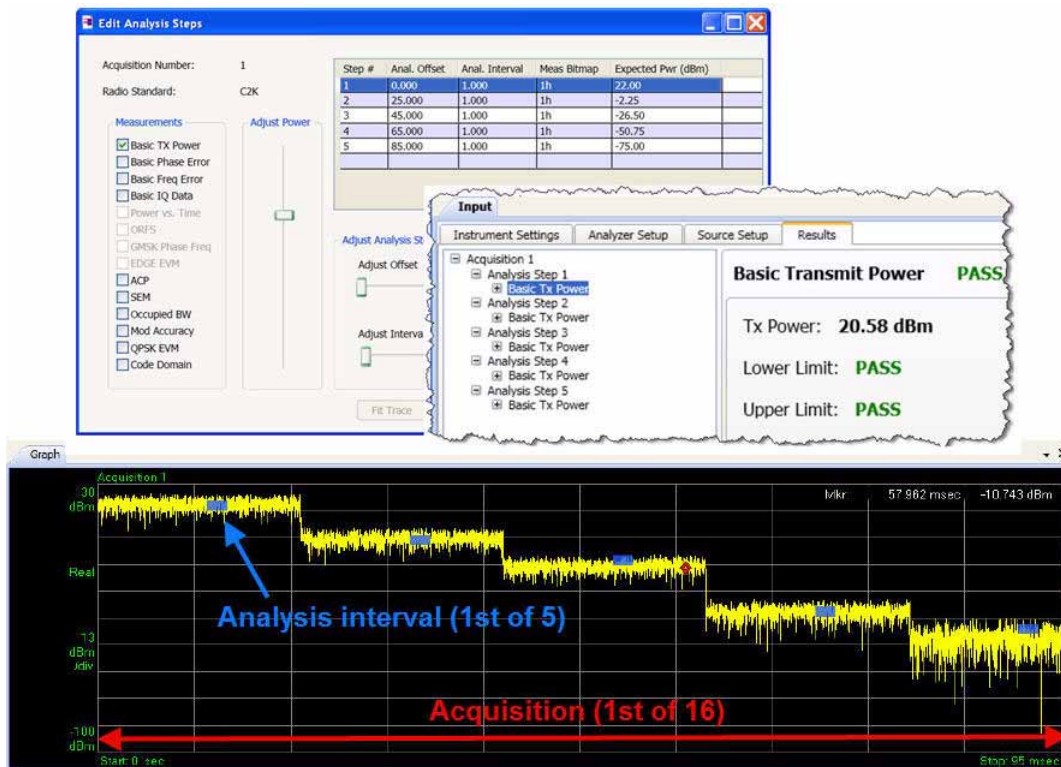

The sequence is completed by adding the remaining 15 acquisitions for the other channels on the list, and adding to each acquisition the set of 5 analysis intervals for the power levels to be measured for each channel.

Figure 11-5 Adding the Remaining 15 Acquisitions to the Sequence

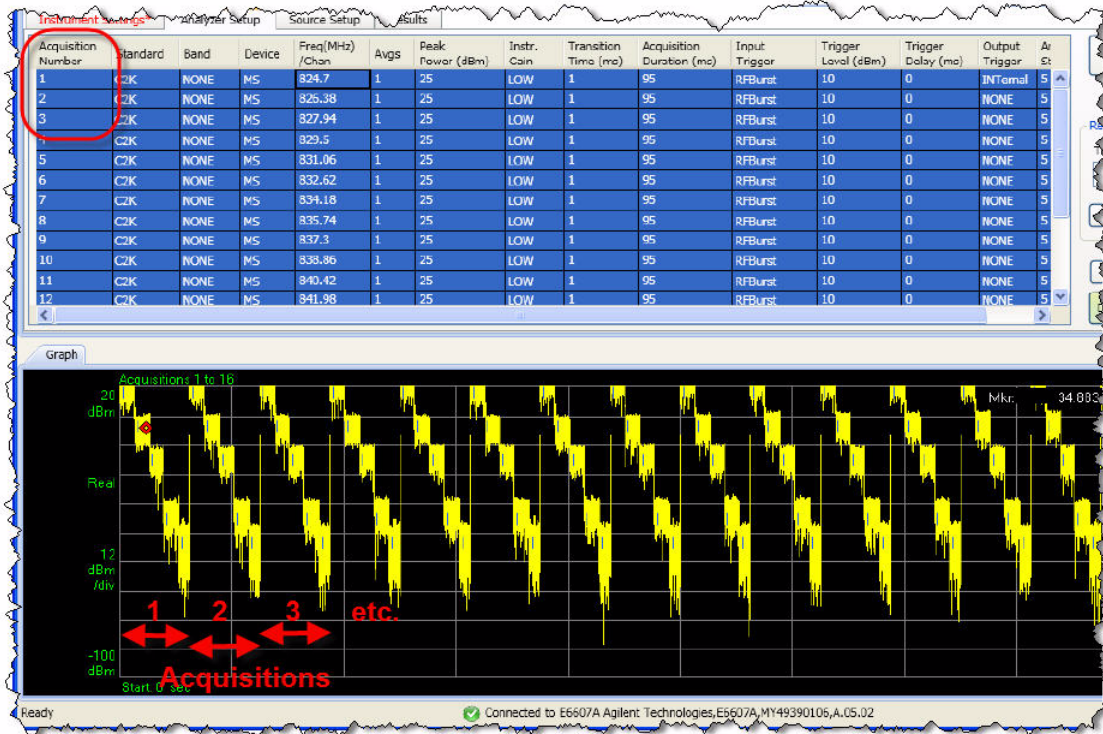

Example Test Scenarios

Calibration Example

When the sequence has been completely set up, Sequence Studio can then save it in any of three formats: a text file containing the sequence parameters as tab-separated values, a set of SCPI commands, or a sequence file (.seq) in a proprietary format which is readable by the EXF test set. The first two formats are illustrated below. (The SCPI commands for a sequence would typically be incorporated into a larger test program which also controls the DUT.)

Figure 11-6 Sequence Exported as Tab Separated Values or SCPI Commands

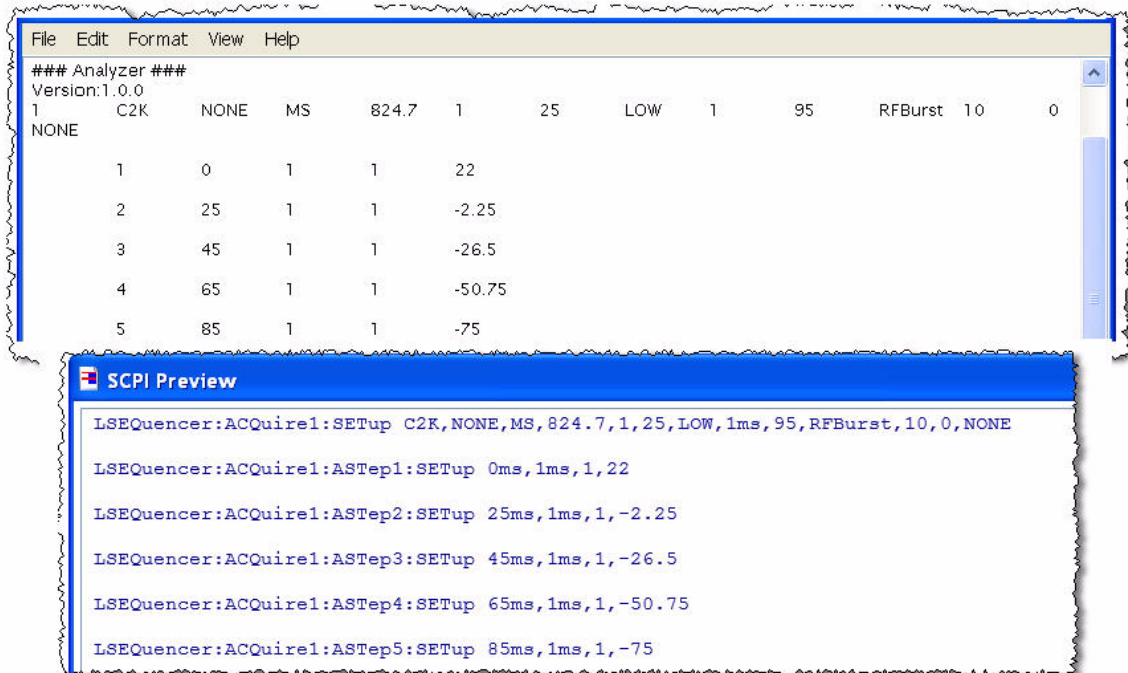

In this example, the DUT-control application runs the sequence, collects the measurement data, and saves calibration factors to the DUT to correct for any differences between expected and measured power.

Verification Example

In this example, we run a verification test known as ILPC (for inter-loop power control) on a WCDMA mobile device.

The test set supplies a 2140 MHz downlink signal to the DUT, and measures a 1950 MHz uplink signal returned by the DUT. The test set uses the same input/output port (RFIO 1) to provide the downlink signal and measure the uplink signal.

ILPC verification requires that the downlink signal be modulated with certain kinds of data which the mobile device would expect to receive from a base station. The test set cannot fully simulate a base station, but in this test the signal from the test set includes the minimum channels (for synchronization and power control of the device) that the ILPC test requires. This is made possible by including those channels in an ARB waveform file, downloading the file to the test set, and using the file to modulate the test set's RF output.

During the ILPC test, the DUT receives (in the downlink signal) inputs which should cause it to increase or decrease the RF power level of the uplink signal. The test set then measures the uplink signal transmitted by the DUT, to confirm that the expected power changes were made.

Figure 11-7 Hardware setup for verification example

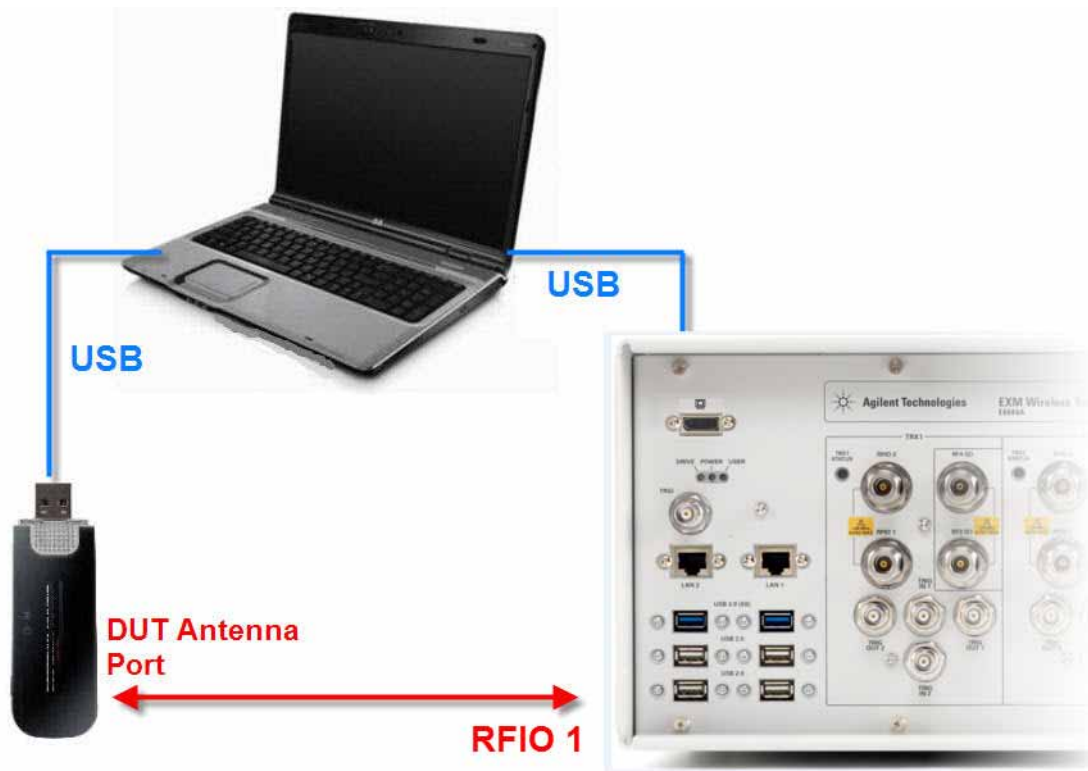

Example Test Scenarios

Verification Example

Implementing this test involves the use of three applications on the PC controller:

- Keysight Signal Studio (N7600B) for 3GPP W-CDMA. This is a tool for creating W-CDMA waveform files.
- A proprietary application, made by the manufacturer of the mobile device, which controls the device through a USB connection.
- Keysight Sequence Studio (U9066A). This is a tool for creating sequences for the EXF test set.

Creating Waveforms

To begin with, we will use Keysight Signal Studio N7600B to create the waveform file which will modulated the downlink signal to the DUT. Two versions of the waveform file will be created: one which sets the DUT to a fixed maximum power level, and one which causes the DUT to step through a rising and falling power sequence.

In Signal Studio, we delete the default Carrier 1, and add a new carrier, selecting “Adv W-CDMA/HSDPA DL” as the carrier type. (This is the advanced version of the W-CDMA download waveform; the basic versions do not support the type of waveform coding that is needed for the ILPC test.)

Figure 11-8 Adding a New Carrier

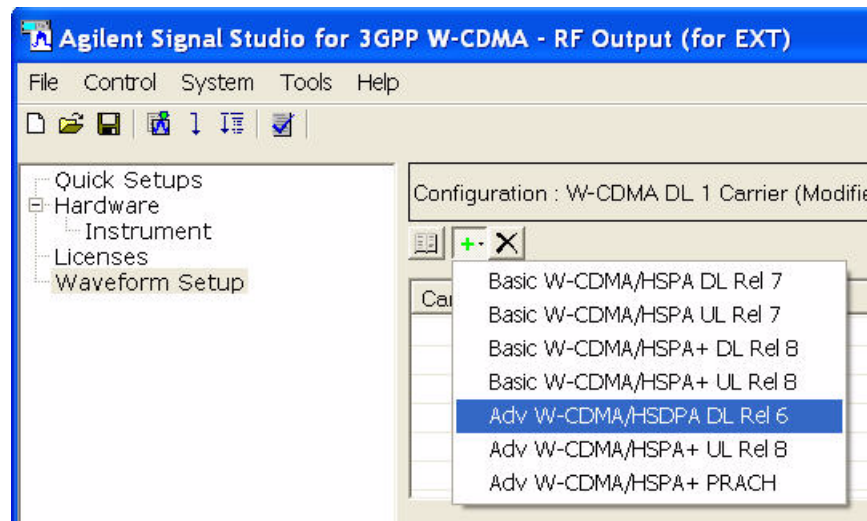

Under the new Carrier 1, we set the Number of Frames to 12.

Figure 11-9 Setting the Number of Frames to 12

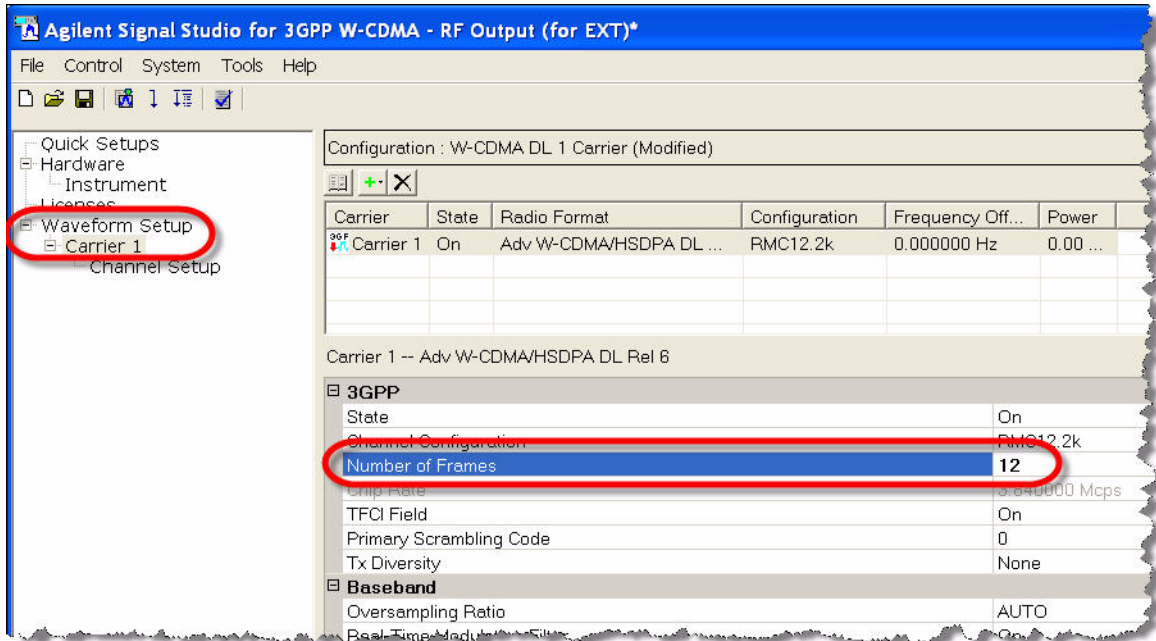

Under Channel Setup for Carrier 1, we find that the waveform includes 22 channels. Most are not necessary for ILPC; we delete all but these five channels: P-CCPCH, PSCH, SSCH, CPICH, and DPCH.

Example Test Scenarios
 Verification Example

Figure 11-10 Deleting Unnecessary Channels

Channel	State	Power	Rate	Spread Code	Data
CH1:P-CCPCH	On	-12.00	15.0	1	BCH
CH2:PSCH	On	-15.01	15.0	N/A	N/A
CH3:SSCH	On	-15.01	15.0	N/A	N/A
CH4:CPICH	On	-10.00	15.0	0	00000000
CH5:PICH	On	-15.00	15.0	2	Paging Indicator
CH6:DPCH	On	-16.60	30.0	96	DCH
CH7:OCNS	On	-9.91	30.0	2	PN9
CH8:OCNS	On	-11.91	30.0	11	PN9
CH9:OCNS	On	-11.91	30.0	17	PN9
CH10:OCNS	On	-13.91	30.0	23	PN9
CH11:OCNS	On	-13.91	30.0	29	PN9
CH12:OCNS	On	-13.91	30.0	35	PN9
CH13:OCNS	On	-13.91	30.0	41	PN9
CH14:OCNS	On	-13.91	30.0	47	PN9
CH15:OCNS	On	-13.91	30.0	53	PN9
CH16:OCNS	On	-13.91	30.0	59	PN9
CH17:OCNS	On	-13.91	30.0	65	PN9
CH18:OCNS	On	-13.91	30.0	71	PN9
CH19:OCNS	On	-13.91	30.0	77	PN9
CH20:OCNS	On	-13.91	30.0	83	PN9
CH21:OCNS	On	-13.91	30.0	89	PN9
CH22:OCNS	On	-13.91	30.0	95	PN9

Channel	State	Power	Rate	Spread Code	Data
CH1:P-CCPCH	On	-12.00	15.0	1	BCH
CH2:PSCH	On	-15.01	15.0	N/A	N/A
CH3:SSCH	On	-15.01	15.0	N/A	N/A
CH4:CPICH	On	-10.00	15.0	0	00000000
CH5:DPCH	On	-16.60	30.0	96	DCH

Most of the five remaining channels can be left as they are. However, DPCH requires two changes. Under Channel Setup, we change the Spreading Code to 9 (as that is the default code for this DUT). We also change the TPC pattern to “All Up”. This means that the Transmit Power Control commands, which the waveform will include in each timeslot, will instruct the DUT to set the uplink signal it transmits to maximum power. (Later we will create an alternative version of the waveform, which uses a different TPC pattern.)

Figure 11-11 Configuring DPCH

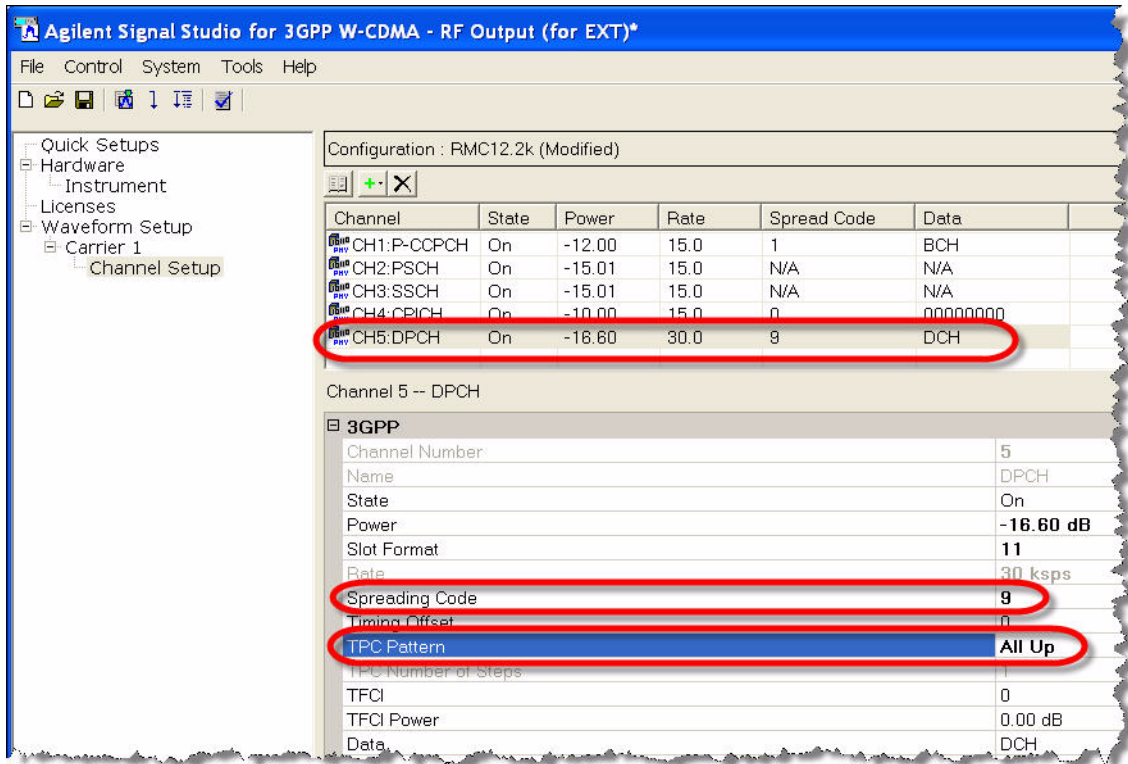

Under Waveform Setup, we change the name of the waveform to “All_Up”.

Figure 11-12 Naming the Waveform “All_Up”

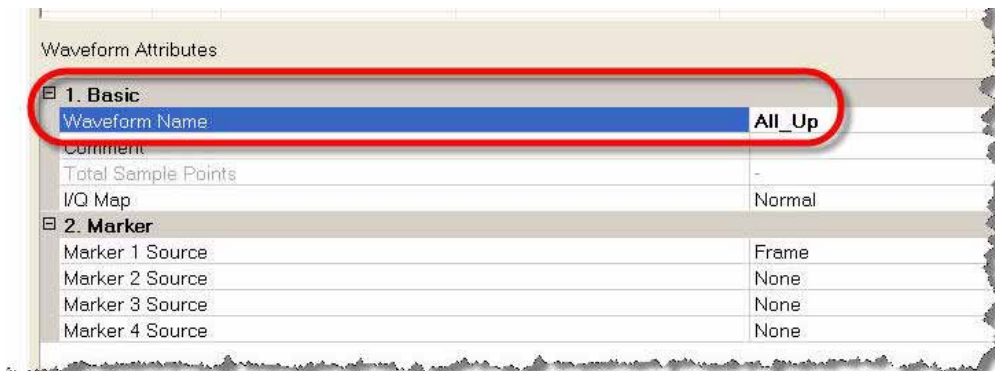

Because, in this case, the Signal Studio application on the PC is connected directly to the EXF test set, we can now generate the waveform and download it directly to the test set by clicking the Generate and Download icon. The waveform file is saved as **All_Up.wfm** in the **D:\NVARB** directory on the hard drive of the test set. If there is no direct connection to the test set, the alternative method is to select “Export Waveform Data” on the File menu, save the waveform file to a USB memory device, and use that device to transfer the file to the hard drive of the test set.

Example Test Scenarios
Verification Example

Figure 11-13 Generating and Downloading the Waveform

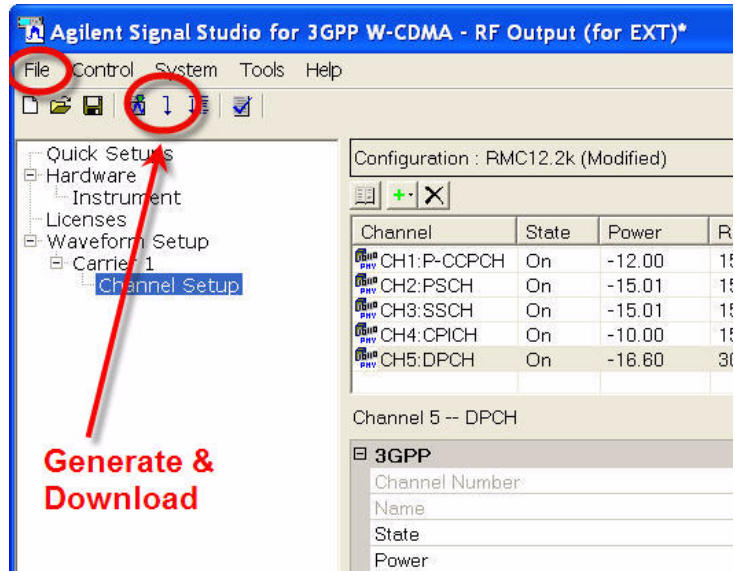

The waveform we have already created can be used to verify that the DUT can receive the downlink signal, synchronize to it, and respond to it. However, to perform the actual ILPC test, we need to create a second waveform which includes TPC commands which correspond to a falling and rising pattern of DUT transmit power, as 2):

Figure 11-14 ILPC Power Profile

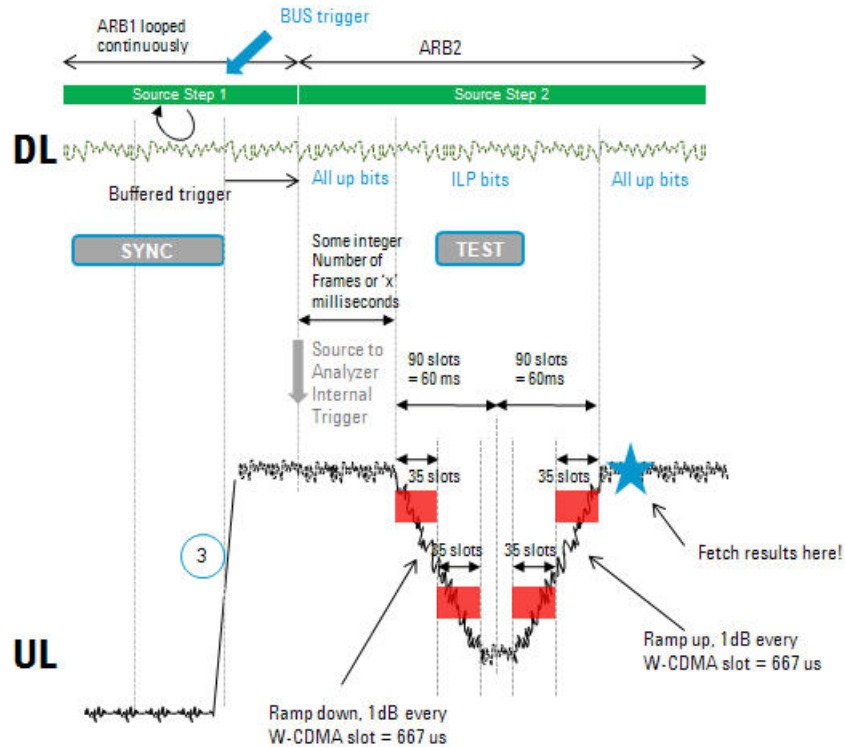

The “down” (0) or “up” (1) values for the TPC commands correspond to falling or rising power in 1 dB or 2 dB increments (depending on the step size that has been set up on the DUT).

To create this series of down commands and up commands, in the Channel Setup for DPCH we change the TPC pattern to “User Defined Bits” and enter a sequence of 90 zeroes followed by 90 ones.

At this point we use the control application for the DUT to instruct the device to start W-CDMA and acquire the pilot (that is, receive and sync up with the downlink signal from the test set). When those instructions have been successfully issued (as indicated by the status messages which the application generates), we instruct the DUT to begin transmitting its uplink signal to the test set.

At this point, the DUT should be transmitting the uplink signal to the test set.

Example Test Scenarios

Verification Example

On the test set, we select the IQ Analyzer mode, and the Complex Spectrum measurement. We set the center frequency to 1950 MHz, and verify that a strong uplink signal is present.

Figure 11-16 Verifying the “All Up” Uplink Signal

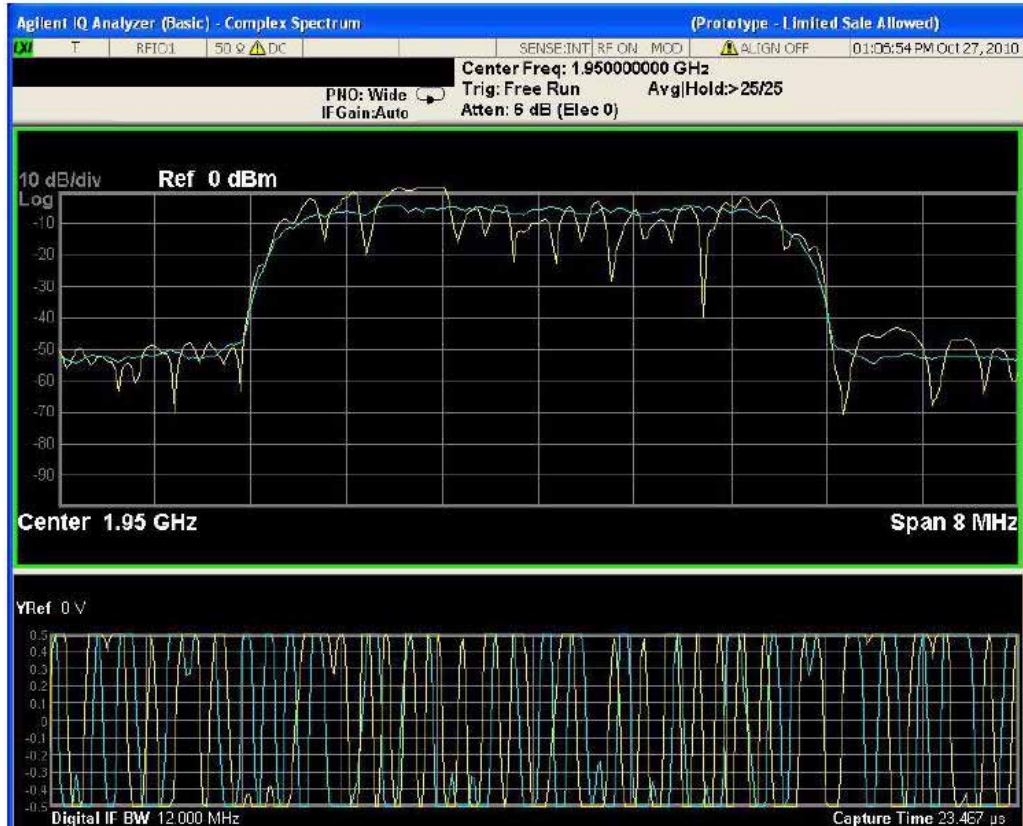

The uplink signal is fixed at maximum power, according to the instructions encoded in the **All_Up.wfm** waveform. The next step will be to use a different waveform file for the downlink. Before changing it, however, we use the DUT control software to shut down the mobile device’s W-CDMA mode temporarily.

On the test set’s Source menu, as described before, we select an ARB waveform (this time the **ILPC.wfm** waveform, which encodes instructions to ramp the power of the uplink signal down and up.)

Once again, we use the control application for the DUT to instruct the device to start W-CDMA and acquire the pilot. Then we instruct the DUT to begin transmitting its uplink signal to the test set. This time, the uplink signal should exhibit the falling and rising power profile which is encoded in the **ILPC.wfm** waveform file. To verify this, we need to configure the IQ Analyzer mode of the test set:

1. Set the Trigger mode to Video, with an absolute level of 0 dBm. The key sequence is: **Trigger, Video, Video, 0**.
2. Select the IQ Waveform measurement. The key sequence is: Meas, **IQ Waveform**.
3. Set Meas Time to 140 ms. The key sequence is: **Meas Setup, Meas Time, 140, ms**.

In this measurement setup, the expected falling and rising power profile should be visible in the IQ Waveform display of the uplink signal from the DUT.

Figure 11-17 Verifying the “ILPC” Uplink Signal

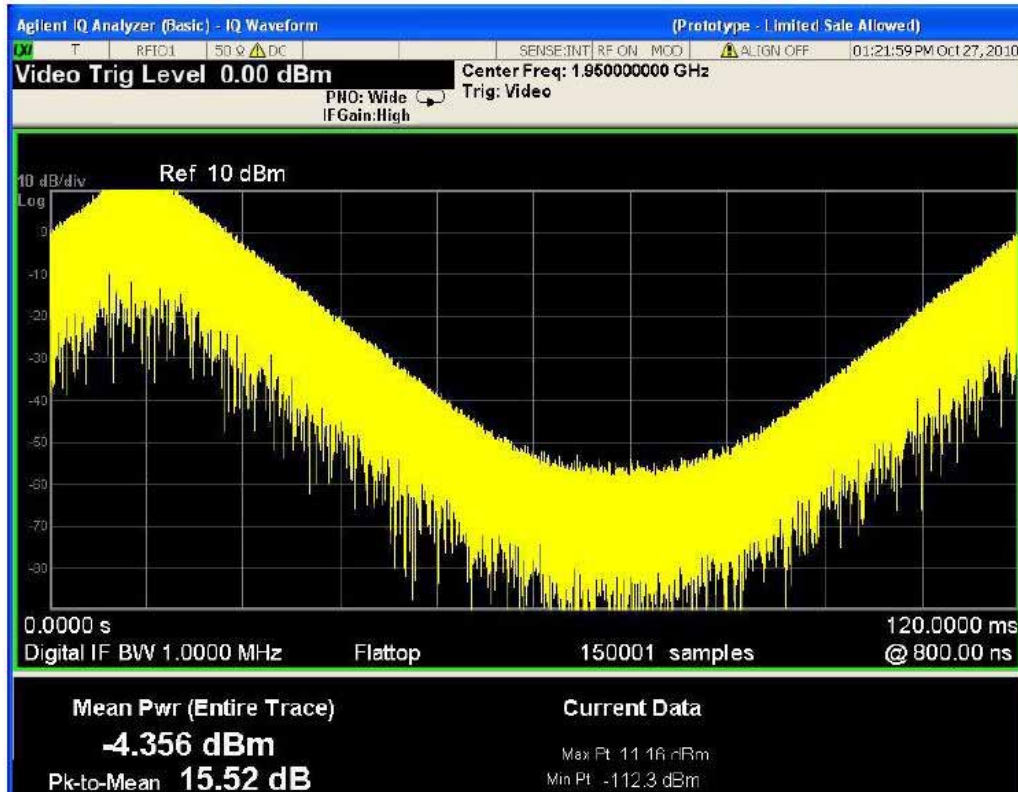

Viewing the uplink signal in this way provides a rough, immediate confirmation that the DUT is modifying its output power in response to the coding of the downlink waveform. To determine more exactly how the DUT is responding, we will set up a sequence with multiple analysis intervals.

Example Test Scenarios

Verification Example

Setting Up The Sequence

With Keysight I/O Libraries running, and “EXT1” established as the VISA alias for the test set, we launch the Sequence Studio application, and click on the “Connect” icon to connect Sequence Studio to the test set. The “Not Connected” message at the bottom of the window is replaced by “Connected to E6650A...”, and the “Connect” icon becomes a “Disconnect” icon.

Figure 11-18 Connecting Sequence Studio to the Test Set

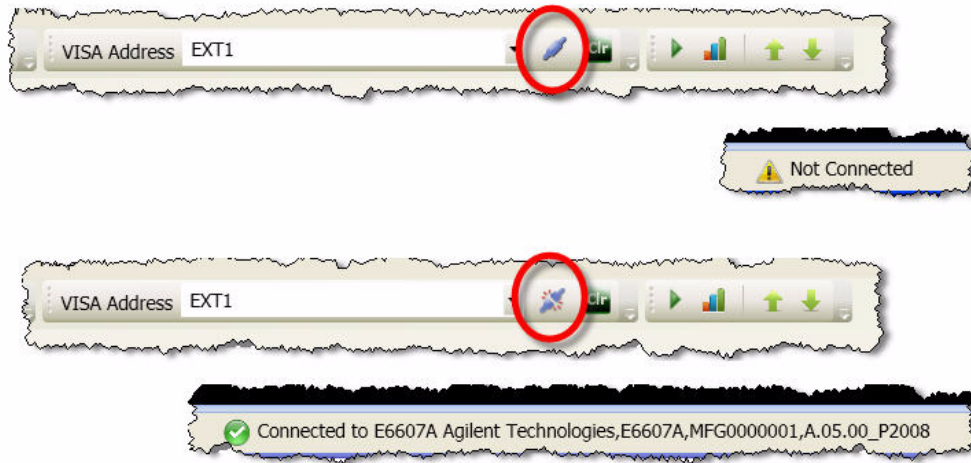

Connecting to the EXF causes the test set’s global instrument settings to be uploaded automatically to Sequence Studio; we will modify these settings as needed for the purposes of the ILPC test. (For example, we will set the IF BW settings on all of the “Basic” measurement tabs to 3.84 MHz.) The title of the “Instrument Settings” tab is shown in red and marked with an asterisk until we have actually transferred the changes in the settings to the test set by clicking the **Download to Instrument** button).

Figure 11-19 Instrument Settings for Sequence Studio

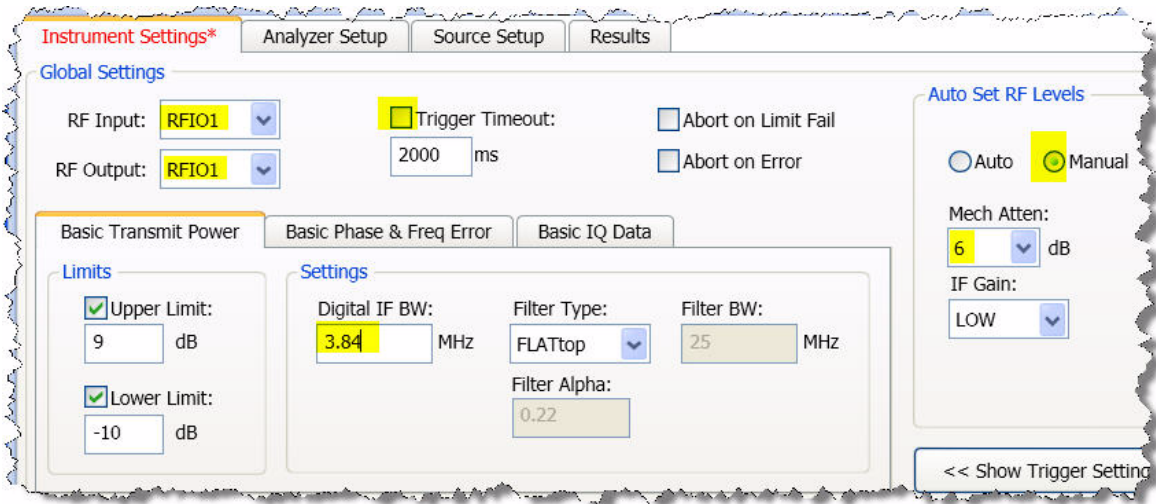

We create an acquisition row for the 1950 MHz uplink, with a long duration (140 MHz) so that the entire falling and rising power sequence can be included.

Figure 11-20 New Acquisition Row

Analyzer Setup							
Acquisition Number	Standard	Band	Device	Freq(MHz) /Chan	Avgs	Peak Power (dBm)	Instr. Gain
1	NONE	NONE	MS	1950	1	25	ZERO

Transition Time (ms)	Acquisition Duration (ms)	Input Trigger	Trigger Level (dBm)	Trigger Delay (ms)	Output Trigger
0.25	140	VIDeo	10	0	NONE

We download this sequence to the test by clicking the **Download to Instrument** button, and click the **Read Sequence Trace** button so that the captured data can be seen in the graph display.

Example Test Scenarios
Verification Example

Figure 11-21 Reading the Sequence Trace

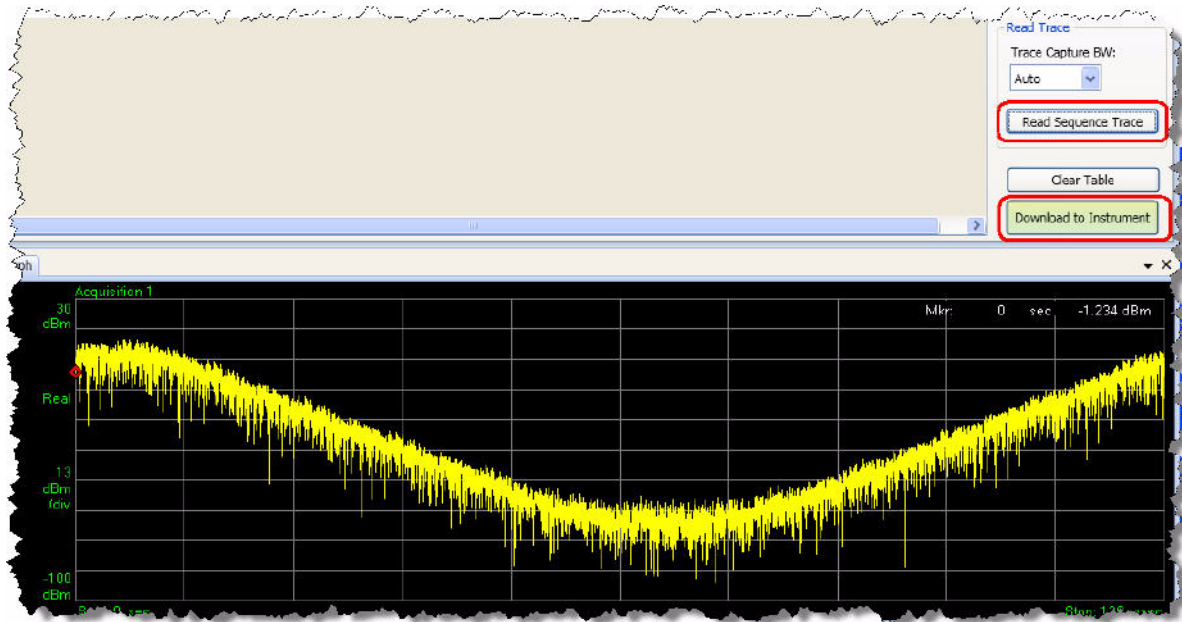

To add measurements to the acquisition, we click **Edit Analysis Steps** and add steps to the table. For the selected step (highlighted in the table), we select a measurements from the checkboxes (**Basic Tx Power** in this case); the **Meas Bitmap** column in the table is automatically updated to reflect our selection of measurements. The **Analysis Offset**, **Analysis Interval**, and **Expected Power** values can be entered in the table directly, but it is more convenient to adjust these values graphically, using the slider bars on the display; the blue bars representing the analysis intervals on the screen change position and width accordingly.

Figure 11-22 Adding Analysis Intervals

Acquisition Number: 1
Radio Standard: NONE

Measurements: Basic TX Power, Basic Phase & Freq, Discrete PAVT, Basic IQ Data

Adjust Power: [Slider]

Step #	Anal. Offset	Anal. Interval	Meas Bitmap	Expected Pwr (dBm)
1	0.000	1.000	1h	25.00
2	12.000	1.000	1h	18.33
3	24.000	1.000	1h	11.67
4	36.000	1.000	1h	5.00
5	48.000	1.000	1h	-1.67
6	60.000	1.000	1h	-8.33
7	72.000	1.000	1h	-15.00
8	84.000	1.000	1h	-21.67
9	96.000	1.000	1h	-28.33

Example Test Scenarios
Verification Example

If the analysis intervals are extremely narrow compared to the width of the captured trace (as they are in this example), it may be difficult to see the blue bars of the analysis interval on the display. To remedy this, the display includes a Zoom feature. Click the rectangle icon, and drag across a rectangular region of the displayed trace to zoom in on it.

Figure 11-23 Zooming the Sequence Trace

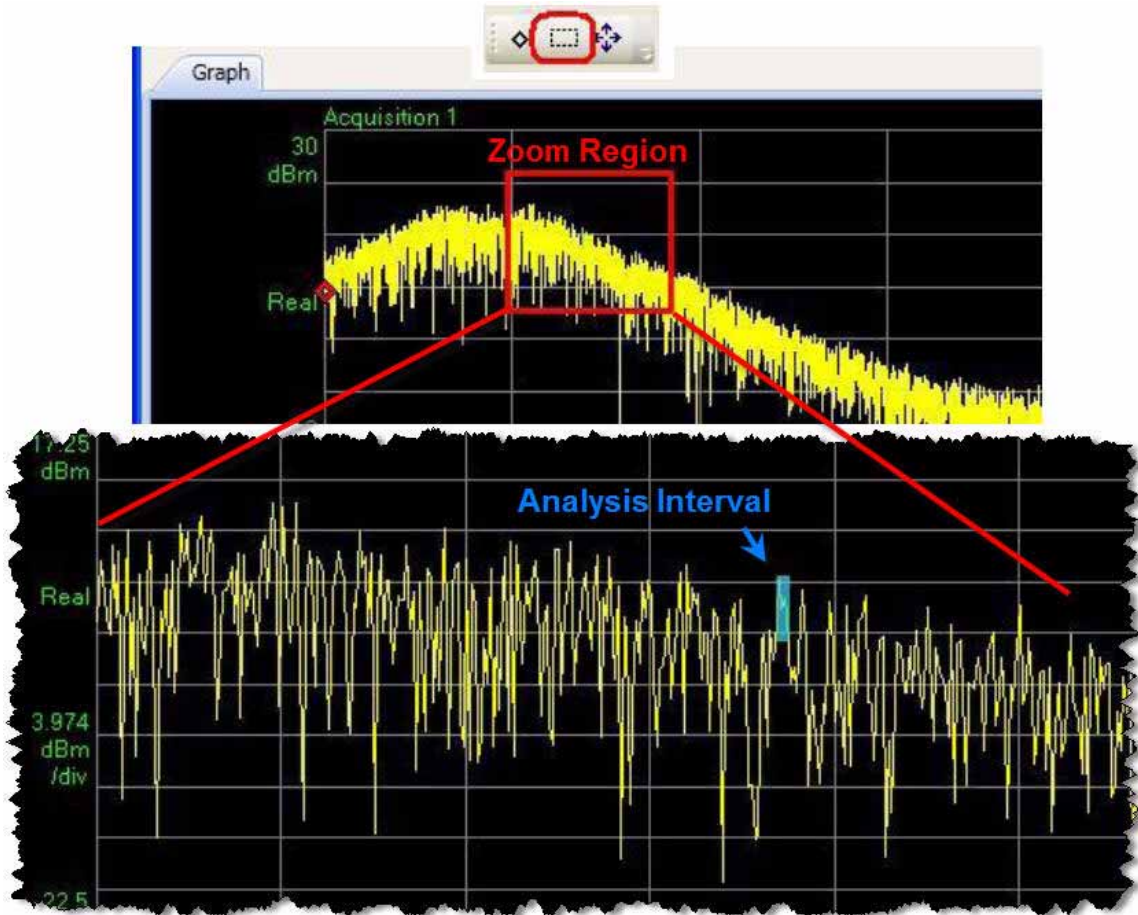

To run the sequence, we click **Download to Instrument** and then press the **Cancel (Esc) / Local** key, followed by the **Restart** key, on the front panel of the EXF test set. To bring up the results, we click the Fetch Results icon on the Sequence Studio toolbar; the results are sorted by acquisition and by analysis steps within each acquisition.

Figure 11-24 Fetching Results

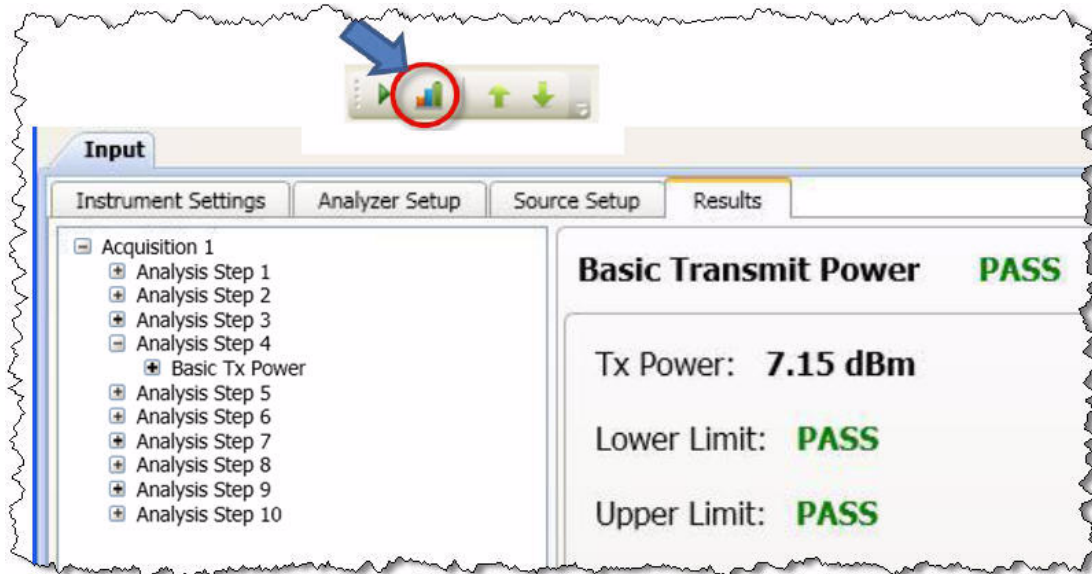

Example Test Scenarios
Verification Example

12 Basic Measurements Programming Commands

There are some basic measurements that are available on the test set without the need to be licensed. These are defined in this chapter.

The chapter topics are:

- **Basic Transmit Power**
- **Basic Frequency and Phase Error**
- **Basic Discrete PAVT**
- **Basic IQ Data**

Basic Transmit Power

The basic transmit power is a measure of the RMS or average power in the received RF signal for the duration specified in the Analysis Interval.

To set up a basic transmit power measurement in the List Sequencer from the front panel do the following:

Step 1. Set the test set to the Sequence Analyzer mode:

Press **Mode, Sequence Analyzer, Mode Preset**.

Step 2. Set up the Basic Transmit Power parameters:

Press **Meas Setup, Basic Meas Setup, Basic Transmit Power Setup**.

Press **Upper Limit** to specify upper limit of power.

Press **Lower Limit** to specify lower limit of power.

Press **Radio Standard [none], Digital IF BW** and adjust as required.

Press **Filter Type** and select as required (**Gaussian, Flattop, Root Raised Cosine, or Short Nyquist**).

Press **Filter BW** and adjust as required (not applicable to flattop filtering).

Press **Filter Alpha** and adjust as required (not applicable to flattop filtering).

Step 3. Set up an Acquisition in the test set. To do this see **“Front Panel List Sequencer Setup” on page 82)**

Figure 12-1 Basic Transmit Power measurement

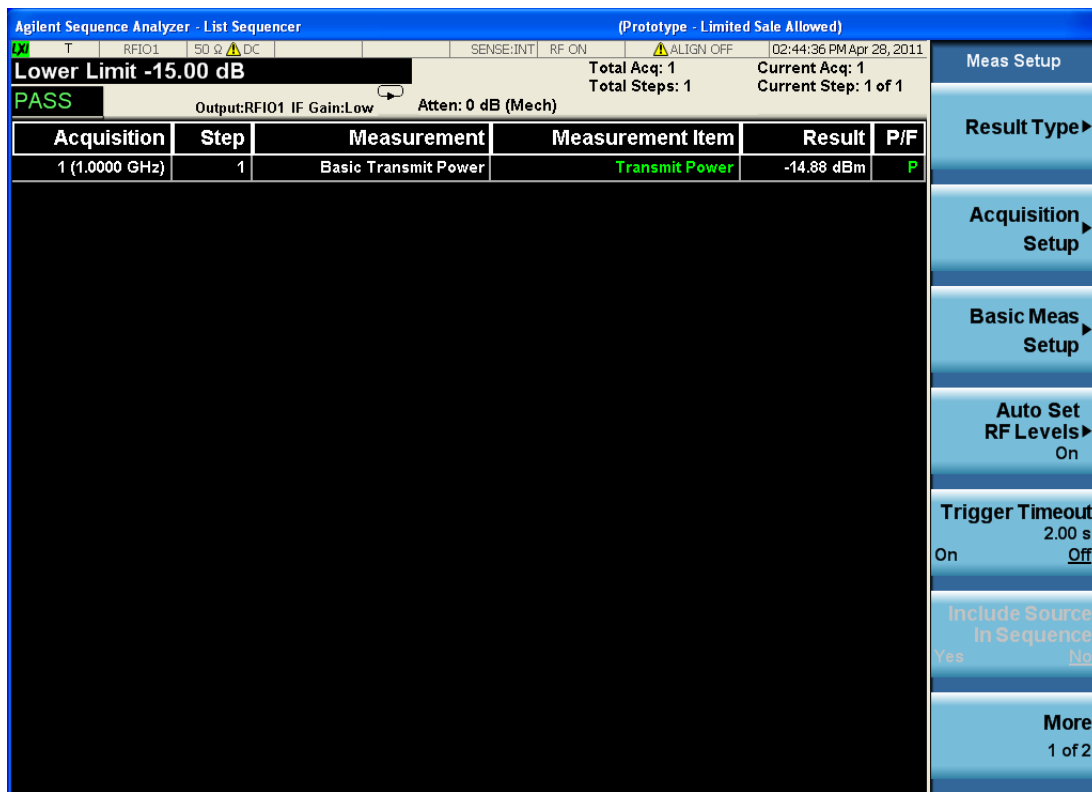

Step 4. Press the **Single** hardkey to run the Sequence.

Basic transmit power measurement SCPI commands

The Basic Transmit Power measurement requires the following parameters to be specified:

- Radio Standard
- Digital IF BW
- Filter Type
- Filter Bandwidth
- Filter Alpha
- Upper and Lower limits

Radio Standard is specified as part of the Acquisition and is a node in some of the SCPI commands so does not have an explicit SCPI command. The following commands are used to set up the remaining parameters:

```
[ :SENSE ] :LSEQuencer:BTXPower: [NONE] :DIF:BANDwidth|BWIDth [:RESolution] <freq>
```

```
[ :SENSE ] :LSEQuencer:BTXPower: [NONE] :DIF:FILTer:TYPE  
GAUSSian|FLATtop|RRC|SNYquist
```

```
[ :SENSE ] :LSEQuencer:BTXPower: [NONE] :DIF:FILTer:BANDwidth|BWIDth  
[:RESolution] <freq>
```

```
[ :SENSe ] :LSEQuencer:BTXPower: [NONE] :DIF:FILTer:ALPHa <real>
```

```
[ :SENSe ] :LSEQuencer:BTXPower:LIMit:UPPer:STATe OFF|ON|0|1
```

```
[ :SENSe ] :LSEQuencer:BTXPower:LIMit:UPPer <rel_ampl>
```

```
[ :SENSe ] :LSEQuencer:BTXPower:LIMit:LOWer:STATe OFF|ON|0|1
```

```
[ :SENSe ] :LSEQuencer:BTXPower:LIMit:LOWer <rel_ampl>
```

For more detailed information about the SCPI commands above refer to the Sequence Analyzer online help (or in pdf format, the User's and Programmer's Reference).

Basic Measurements Programming Commands

Basic Transmit Power

Basic transmit power results

The parameters and default setting for this command are detailed in the following table. The first SCPI parameter is Index 0.

Index	Result Parameter
0	Overall Pass/Fail result - shows the mask test result (0.0 = pass, 1.0 = fail, -1.0 not tested)
1	Upper Limit Pass/Fail Result shows the upper limit test result (0.0 = pass, 1.0 = fail, -1.0 not tested)
2	Lower Limit Pass/Fail Result shows the upper limit test result (0.0 = pass, 1.0 = fail, -1.0 not tested)
3	Basic Tx Power is the accumulated power over the measurement interval set for this Analysis Interval. It is a floating point number.

Basic Frequency and Phase Error

The basic frequency error is a measure of the frequency error in the received RF signal relative to the frequency that is measured in the first Analysis Interval. The basic phase error is a measure of the phase error in the received RF signal with reference to the frequency set for the Acquisition for the duration specified in the Analysis Interval.

To set up a basic frequency and phase error measurement in the List Sequencer for a GSM signal from the front panel, do the following:

Step 1. Set the test set to the Sequence Analyzer mode:

Press **Mode, Sequence Analyzer, Mode Preset**.

Step 2. Set up the GSM/EDGE Basic Frequency and Phase Error parameters:

Press **Meas Setup, Basic Meas Setup, Basic Phase Error Setup**.
Change the **Info BW** as required.

Step 3. Set up an Acquisition in the test set. To do this see **“Front Panel List Sequencer Setup” on page 82)**

Figure 12-2 Basic Frequency and Phase Error measurement



Step 4. Press the **Single** hardkey to run the Sequence.

Basic Measurements Programming Commands

Basic Frequency and Phase Error

Basic Frequency and Phase Error Measurement SCPI Commands

The Basic Frequency and Phase Error measurement requires the following parameters to be specified:

- Digital IF BW
- Limit Freq Error

The following commands are used to set up these parameters:

```
[ :SENSE ] :LSEQuencer:BFERor:DIF:BAWdth[ :RESolution] <freq>
```

```
[ :SENSE ] :LSEQuencer:BFERor:LIMit:PPM OFF|ON|0|1
```

```
[ :SENSE ] :LSEQuencer:BFERor:LIMit:PPM <real>
```

For more detailed information about the SCPI commands above refer to the Sequence Analyzer online help (or in pdf format, the User's and Programmer's Reference).

Basic Frequency and Phase Error results

The parameters and default setting for this command are detailed in the following table. The first SCPI parameter is Index 0.

Index	Result Parameter
0	Pass/Fail Result shows the test result against the "Limit: Freq Error" ppm value. 0:Pass, 1:Fail, -1:Not tested.
1	Frequency Error is a floating point number that represents the frequency error in Hz between the test set's tuned analyzer freq for the acquisition and the current analysis step. The frequency error is the average of all samples in the measurement interval of the analysis step. This is the difference between the measured phase trajectory and the reference phase trajectory.
2	Phase Error is a floating point number that represents the phase error in degrees between the test set's tuned analyzer phase for the acquisition and the current analysis step. The phase of each sample in the analysis interval is calculated and averaged. The result returned is an average of the phase of each sample.

Basic Discrete PAVT

This measurement returns the amplitude, phase and frequency errors of each step. For the first step, frequency errors are referenced to the frequency set for the acquisition, and phase is taken as zero. The amplitude, frequency and phase errors of the remaining steps are referenced to the first step. Because Basic Discrete PAVT needs to set the channel filter, it is exclusive with other measurements; once Basic Discrete PAVT measurement is selected for one analysis of this acquisition, only Basic Discrete PAVT is allowed for all analyses of this acquisition.

To set up a basic discrete PAVT measurement in the List Sequencer for a GSM signal from the front panel do the following:

Step 1. Set the test set to the Sequence Analyzer mode:

Press **Mode, Sequence Analyzer, Mode Preset**.

Step 2. Set up the GSM/EDGE Basic Discrete PAVT parameters:

Press **Meas Setup, Basic Meas Setup, Basic Frequency Error Setup**.
Change the **Info BW** as required.

Step 3. Set up an Acquisition in the test set. To do this see **“Front Panel List Sequencer Setup” on page 82)**

Figure 12-3 Basic Discrete PAVT measurement

Agilent Sequence Analyzer - List Sequencer (Prototype - Limited Sale Allowed)

Lower Limit -15.00 dB Total Acq: 1 Current Acq: 1
Total Steps: 1 Current Step: 1 of 1

Output:RFIO1 IF Gain:Low Atten: 0 dB (Mech)

Acquisition	Step	Measurement	Measurement Item	Result	P/F
1 (1.0000 GHz)	1	Basic Discrete PAVT	Basic Discrete PAVT	(Remote Only)	---

Meas Setup
Result Type ▶
Acquisition Setup ▶
Basic Meas Setup ▶
Auto Set RF Levels ▶
On
Trigger Timeout 2.00 s
On Off
Include Source In Sequence
Yes No
More
1 of 2

Step 4. Press the **Single** hardkey to run the Sequence.

Basic Measurements Programming Commands

Basic Discrete PAVT

Basic Discrete PAVT Measurement SCPI Commands

The Basic Discrete PAVT measurement requires the following parameters to be specified:

- Filter Type
- Interval Count
- Interval Centers
- Interval Widths

The following commands are used to set up these parameters:

```
[ :SENSe ] :LSEQuencer:PCALibration:FILTEr WIDE|NARRow|VNARrow|ENARrow
```

```
[ :SENSe ] :LSEQuencer:PCALibration:STEP:COUNT <integer>
```

```
[ :SENSe ] :LSEQuencer:PCALibration:STEP:CENTEr <time>, ..., < time >
```

```
[ :SENSe ] :LSEQuencer:PCALibration:WIDTh <time>, ..., < time >
```

For more detailed information about the SCPI commands above refer to the Sequence Analyzer online help (or in pdf format, the User's and Programmer's Reference).

Basic Discrete PAVT Results

The parameters and default setting for this command are detailed in the following table. The first SCPI parameter is Index 0.

Index	Result Parameter
0	Number of steps to be measured.
1	Returns a 512 length list of comma-separated values for the amplitude of each step. The first step amplitude result is absolute value. The results of other steps are referenced to the first step and they are relative value.
2	Returns a 512 length list of comma-separated values for the phase error of each step. The first step phase error result is as the zero. The results of other steps are referenced to the first step phase.
3	Returns a 512 length list of comma-separated values for the frequency error of each step. The first step frequency error result is referenced to the frequency set of the acquisition. The results of other steps are referenced to the first step frequency error result.

Basic IQ Data

If Basic IQ data is included in the Measurement Bit Mask, then this allows for a limited amount of IQ data to be returned over SCPI, to allow for further analysis outside the test set. Other measurement results are shown on the front panel and can also be accessed remotely over SCPI, but the Basic IQ data is only available over SCPI. The amount of data that can be output is specified in the test set specifications document which is available on the Keysight website, www.keysight.com/find/e6650a.

NOTE In any acquisition, averaging must not be on (greater than one) when any of the measurement bit masks within the acquisition includes Basic IQ data.

There are two parameters associated with Basic IQ and these are Info BW and Min Sample Rate. These two parameters apply to the whole Sequence unless changed by a Delta parameter. Information bandwidth or Info BW is a parameter that is set the hardware filter in front of the analog-to-digital (ADC) converter.

Basic IQ measurement SCPI commands

The Basic IQ measurement requires the following parameters to be specified:

- Digital IF BW
- Measurement Type (raw IQ data samples or amplitude/phase pairs)

The following commands are used to set up these parameters:

```
[ :SENSe ] :LSEQuencer:BIQData:DIF:BANDwidth[:RESolution] <freq>
```

```
[ :SENSe ] :LSEQuencer:BIQData:TYPE RDATA|APHase
```

For more detailed information about the SCPI commands above refer to the Sequence Analyzer online help (or in pdf format, the User's and Programmer's Reference).

Basic Measurements Programming Commands

Basic IQ Data

Basic IQ Data Results

The parameters and default setting for this command are detailed in the following table. The first SCPI parameter is Index 0.

Index	Result Parameter
0	Number of IQ Pairs or Amplitude/Phase Pairs.
1	Info Band width used to capture IQ Pairs.
2	Sample Interval used to capture IQ Pairs.
3	Sample Frequency used to capture IQ Pairs.
4	Peak power of the measurement interval. NAN will be returned if the measurement type is set to IQ samples pairs.
5	Average power of the measurement interval. NAN will be returned if the measurement type is set to IQ samples pairs.

13 GSM/EDGE Programming Commands

This chapter lists all the commands used to set up the GSM/EDGE measurements from within the List Sequencer.

NOTE See also: mode parameters related to GSM/EDGE, as described in **“Mode and Measurement Parameters”** on page 52.

The chapter topics are:

- **GMSK Phase and Frequency (PFER)**
- **GSM Loopback BER**
- **EDGE Power vs. Time (PvT)**
- **EDGE Error Vector Magnitude (EVM)**
- **EDGE Output RF Spectrum (ORFS)**
- **EDGE Loopback BER**

GSM/EDGE Programming

GSM/EDGE measurements can be made in the List Sequencer when you have the GSM/EDGE measurement application licensed in the test set. The SCPI commands for setting each of the GSM/EDGE measurements from inside the Sequence Analyzer mode are listed in this chapter. Changes to these parameters made from within the List Sequencer result in changes to the equivalent parameters in the measurement mode.

The GSM/EDGE measurements that are supported in the List Sequencer are:

- GMSK Phase and Frequency Error (PFER)
- GSM Loopback BER
- EDGE Power vs. Time (PvT)
- EDGE Error Vector Magnitude (EVM)
- EDGE Output RF Spectrum (ORFS)
- EDGE Loopback BER

GMSK Phase and Frequency (PFER)

This section provides the remote control SCPI commands for the GMSK Phase and Frequency (PFER) measurement from within the List Sequencer. This measurement is available only if you have the GSM/EDGE measurement application licensed on the test set.

For more detailed information about the GMSK PFER measurement, refer to the online help associated with the GSM/EDGE measurement application, which is also available in PDF format (“User’s and Programmer’s Reference”) on the Keysight website, www.keysight.com/find/e6650a.

You can also refer to the measurement guide for the X-series GSM/EDGE measurement application, which is available on the Keysight website, www.keysight.com/find/mxa.

PFER measurement SCPI commands

There is a set of SCPI commands available to program the GMSK PFER measurement when it is used in the GSM/EDGE mode. To set up the GSM measurements from within the Sequence Analyzer mode you need to prefix the SCPI commands with `LSEQuencer:EDGE`. For example, the `[:SENSE] :PFERror` part of the PFER SCPI commands are replaced with:
`[:SENSE] :LSEQuencer:EDGE:PFERror`

NOTE “EDGE” (and not “GSM”) is used to designate the GSM/EDGE mode in commands

The following commands are used to set up the PFER measurement.

```
[ :SENSE ] :LSEQuencer:EDGE:PFERror:BSYNc:SOURce  
:CALCulate:LSEQuencer:EDGE:PFERror:LIMit:TEST [ :STATe ] OFF | ON | 0 | 1  
:CALCulate:LSEQuencer:EDGE:PFERror:LIMit:BTS:RPHase  
:CALCulate:LSEQuencer:EDGE:PFERror:LIMit:MS:RPHase  
:CALCulate:LSEQuencer:EDGE:PFERror:LIMit:BTS:PPHase  
:CALCulate:LSEQuencer:EDGE:PFERror:LIMit:MS:PPHase  
:CALCulate:LSEQuencer:EDGE:PFERror:LIMit:BTS:FERRor  
:CALCulate:LSEQuencer:EDGE:PFERror:LIMit:MBTS:FERRor  
:CALCulate:LSEQuencer:EDGE:PFERror:LIMit:PBTS:FERRor  
:CALCulate:LSEQuencer:EDGE:PFERror:LIMit:MS:FERRor
```

PFER results

Index	Result Parameter
0	Overall PFER pass/fail result. It combines all the pass/fail values from the results below and OR's them together. If any fail, this result is 0.0 = pass, 1.0 = fail.
1	RMS Phase Error pass/fail result (0.0 = pass, 1.0 = fail)
2	Peak Phase Error pass/fail result (0.0 = pass, 1.0 = fail)
3	Frequency Error pass/fail result (0.0 = pass, 1.0 = fail)
4	Average RMS Phase Error is a floating point number (in degrees) of the RMS phase error between the measured phase and the ideal phase over the entire burst. The calculation is based on symbol decision points and points halfway between symbol decision points (that is, 2 points/symbol). If part of an average group, the RMS values are averaged.
5	Maximum RMS Phase Error is a floating point number (in degrees) of the RMS phase error between the measured phase and the ideal phase over the entire burst. The calculation is based on symbol decision points and points halfway between symbol decision points (i.e. 2 points/symbol). If part of an average group, then it takes the highest RMS value.
6	Average Peak Phase Error is a floating point number (in degrees) of the peak phase error of all the individual symbol decision points (prior to the RMS averaging process). If part of an average group, the RMS values are averaged.
7	Maximum Peak Phase Error is a floating point number (in degrees) of the peak phase error of all the individual symbol decision points (prior to the RMS averaging process). If part of an average group, then it takes the highest.
8	Peak Phase Error Symbol Position is a floating point number (in symbols) representing the symbol number at which the peak phase error occurred. If part of an average group, then it takes the result of the last burst.
9	Maximum Peak Phase Error Symbol Position is a floating point number (in symbols) representing the symbol number at which the peak phase error occurred.
10	Average Frequency Error is a floating point number (in Hz) of the frequency error over the entire measurement area. This is the difference between the measured phase trajectory and the reference phase trajectory.
11	Maximum Frequency Error is a floating point number (in Hz) of the frequency error over the measurement area. This measurement takes the peak frequency error from each burst and identifies the highest value.
12	Average I/Q Origin Offset is a floating point number (in dB) of the I and Q error (magnitude squared) offset from the origin over the entire measurement area.
13	Maximum I/Q Origin Offset is a floating point number (in dB) of the maximum I and Q error (magnitude squared) offset over the entire measurement area.
14	Average T0 Offset is a floating-point number of the time interval (in seconds) between the slot boundary and T0. T0 is the transition time from symbol 13 to symbol 14 of the midamble training Sequence for each time slot. The 'RF Sync Delay' under 'Mode Setup' is not considered in this measurement.

15	Maximum T0 Offset is a floating-point number of the time interval (in seconds) between the trigger point to T0. T0 means the transition time from symbol 13 to symbol 14 of the midamble training Sequence for each time slot. Takes the T0 Offset from each burst and identifies the highest. The 'RF Sync Delay' under 'Mode Setup' is not considered in this measurement.
16	<p>Detected Training Sequence Code (TSC) is a floating point number of detected TSC in the last measurement burst. The returned value is</p> <p>0~7 for Burst Type: Normal 10 for Burst Type: Sync, 20 for Burst Type: Access (if TSC detected).</p> <p>If TSC (Normal), Extended Training Sequence Bits (Sync) or Synch Sequence Bits (Access) are not detected, the returned value is -999.0.</p> <p>If Amptd or NONE (Power vs Time only) is specified in Sync Type, the returned value is -999.0.</p> <p>In multi slot condition, the returned value is the detected TSC of the specified slot (Time Slot ON) or the first evaluated slot (Time Slot OFF).</p>

NOTE The following QPSK EVM results, which would be returned if the measurement were run in the GSM/EDGE measurement mode, are not returned when the measurement is run in Sequence Analyzer mode:

- Unprocessed I/Q Trace Data
 - Phase Error Trace
 - Phase Error With Frequency Trace
 - Log Magnitude Trace
 - I/Q Corrected Trace
 - Demodulated Data
 - Trace Phase Sample
 - Trace Bit 0 Decision Offset
 - Trace Sync Start
 - Trace Time Sample
-

GSM Loopback BER

This section provides the remote control SCPI commands for the GSM Loopback BER measurement from within the List Sequencer. This measurement is available only if you have the GSM/EDGE measurement application licensed on the test set.

The GSM Loopback BER measurement is based on the GMSK Phase and Frequency (PFER) measurement, and uses remote commands associated with that measurement.

For more detailed information about the GMSK Phase and Frequency measurement, refer to the online help associated with the GSM/EDGE measurement application, which is also available in PDF format (“User’s and Programmer’s Reference”) on the Keysight website, www.keysight.com/find/e6650a.

Loopback BER measurement SCPI commands

The following commands are used to set up the Loopback BER measurement from within the sequence analyzer mode.

```
[ :SENSe ] :LSEQuencer :EDGE :PFERror :BSYNc :SOURce
```

NOTE “EDGE” (and not “GSM”) is used to designate the GSM/EDGE mode in commands

Loopback BER results

Index	Result Parameter
0	Loopback bit error ratio.
1	Total tested bit number.
2	Failed bit number.
3	Reserve.

EDGE Power vs. Time (PvT)

This section provides the remote control SCPI commands for the EDGE Power vs. Time (PvT) measurement from within the List Sequencer. This measurement is available only if you have the GSM/EDGE measurement application licensed on the test set.

For more detailed information about the PvT measurement, refer to the online help associated with the GSM/EDGE measurement application, which is also available in PDF format (“User’s and Programmer’s Reference”) on the Keysight website, www.keysight.com/find/e6650a.

You can also refer to the measurement guide for the X-series GSM/EDGE measurement application, which is available on the Keysight website, www.keysight.com/find/mxa.

EDGE Power vs. Time (PvT) measurement SCPI commands

There is a set of SCPI commands available to program the EDGE PvT measurement when it is used in the GSM/EDGE mode. To set up the GSM measurements from within the Sequence Analyzer mode you need to prefix the SCPI commands with `LSEQuencer:EDGE`. For example, the `[:SENSE] :EPVTime` part of the EDGE PvT SCPI commands are replaced with `[:SENSE] :LSEQuencer:EDGE:EPVTime`.

The following commands are used to set up the EDGE PvT measurement.

```
[ :SENSE ] : ] LSEQuencer:EDGE:EPVTime:BANDwidth [ :RESolution ] <bandwidth>

[ :SENSE ] : LSEQuencer:EDGE:EPVTime:BANDwidth [ :RESolution ] :TYPE
FLATtop | GAUSSian

[ :SENSE ] : LSEQuencer:EDGE:EPVTime:BSYNc:SOURCE
TSEQUence | RFBURst | NONE | RFAMPLitude

:CALCulate:LSEQuencer:EDGE:EPVTime:LIMit:TEST:STATE OFF | ON | 0 | 1

[ :SENSE ] : LSEQuencer:EDGE:EPVTime:MASK:SELect STANDARD | CUSTOM

[ :SENSE ] : LSEQuencer:EDGE:EPVTime:MASK:RPOWER:TYPE UPART | MAMBLE | ESTimated

[ :SENSE ] : LSEQuencer:EDGE:EPVTime:MASK:RPOWER <ampl>

[ :SENSE ] : LSEQuencer:EDGE:EPVTime:BSYNC:SLENgth EVEN | INTEger

[ :SENSE ] : LSEQuencer:EDGE:EPVTime:MASK:LIST:LOWer:ABSolute <real>, ...

[ :SENSE ] : LSEQuencer:EDGE:EPVTime:MASK:LIST:LOWer:POINTs?

[ :SENSE ] : LSEQuencer:EDGE:EPVTime:MASK:LIST:LOWer:RELative <rel_ampl>

[ :SENSE ] : LSEQuencer:EDGE:EPVTime:MASK:LIST:LOWer:TIME <seconds>, ...

[ :SENSE ] : LSEQuencer:EDGE:EPVTime:MASK:LIST:UPPer:ABSolute <real>, ...

[ :SENSE ] : LSEQuencer:EDGE:EPVTime:MASK:LIST:UPPer:POINTs?

[ :SENSE ] : LSEQuencer:EDGE:EPVTime:MASK:LIST:UPPer:RELative <rel_ampl>, ...

[ :SENSE ] : LSEQuencer:EDGE:EPVTime:MASK:LIST:UPPer:TIME <seconds>, ...

[ :SENSE ] : LSEQuencer:EDGE:EPVTime:MASK [ :UPART ] :LOWer:NORMAL QAM16 | QAM32,
<rel_ampl>
```

GSM/EDGE Programming Commands
EDGE Power vs. Time (PvT)

```
[ :SENSe] :LSEQuencer :EDGE :EPVTime :MASK [ :UPARt] :LOWer :HSRate QAM16 | QAM32 ,  

<rel_ampl>
```

EDGE PvT results

Index	Result Parameter
0	Overall Pass/Fail Result shows the mask test result (0.0 = pass, 1.0 = fail, -1.0: Not tested)
1	Power of single burst is the mean power (in dBm) across the useful part of the selected burst in the most recently acquired data, or in the last data acquired at the end of a set of averages. If averaging is on, the power is for the last burst.
2	Power averaged is the power (in dBm) of N averaged analysis step intervals, if averaging is on. The power is averaged across the useful part of the analysis step interval. Average m is a single timeslot from the Acquisition. If there are multiple timeslots in the analysis step interval, only one timeslot is used for average m. This means that N analysis steps are acquired to make the complete average. If average is off, the value of the power averaged is the same as the power single burst value.
3	Start is the index of the data point at the start of the useful part of the burst.
4	Stop is the index of the data point at the end of the useful part of the burst.
5	T0 is the index of the data point where t0 occurred.
6	Burst width is the width of the burst measured at 3 dB below the mean power in the useful part of the burst.
7	Maximum value is the maximum value of the most recently acquired data (in dBm).
8	Minimum value is the minimum value of the most recently acquired data (in dBm).
9	Burst search threshold is the value (in dBm) of the threshold where a valid burst is identified, after the data has been acquired.
10	First error point is the time (in seconds) which indicates the point on the X-scale where the first failure of a signal was detected. If the limit passes, this data has no meaning.

11	<p>Detected Training Sequence Code (TSC) is the most recently detected TSC. The returned value is 0~7 (Burst Type : Normal/Higher Symbol Rate (HSR)) if TSC is detected. If TSC is not detected, the returned value is -999.0. If Amptd or NONE (Power vs Time only) is specified in Sync Type, the returned value is -999.0. In multi slot condition, the returned value is the detected TSC of the specified slot (Time Slot ON) or the first evaluated slot (Time Slot OFF).</p> <p>Note: The returned value in Sync (Synchronization Burst) is.</p> <p>10 if (BN42, BN43..BN105) = (1,0,1,1,1,0,0,1,0,1,1,0,0,0,1,0,0,0,0,0,1,0,0,0,0,0,1, 1,1,1,0,0,1,0,1,1,0,1,0,0,0,1,0,1,0,1,1,1,0,1,1,0,0,0,0,1,1,0,1,1)</p> <p>11 if (BN42, BN43..BN105) = (1,1,1,0,1,1,1,0,0,1,1,0,1,0,1,1,0,0,1,0,1,0,0,0,0,1,1,1,1,1,0,1, 1,1,1,0,1,0,0,0,1,1,1,1,1,0,1,1,0,0,1,0,1,1,0,0,0,1,0,1,0,1)</p> <p>12 if (BN42, BN43..BN105) = (1,1,1,0,1,1,0,0,0,0,1,1,0,1,1,1,0,1,0,1,0,0,0,1,0,1,0,1,1,0, 1,0,0,1,1,1,1,0,0,0,0,0,1,0,0,0,0,0,1,0,0,0,1,1,0,1,0,0,1,1,1,0)</p> <p>The returned value in Access (Access Burst) is</p> <p>20 if (BN8, BN9..BN48) = (0,1,0,0,1,0,1,1,0,1,1,1,1,1,1,1,0,0,1,1,0,0,1,1,0,1,0,1,0,1,0,1,0,0,0,1,1,1,1,0,0,0)</p> <p>21 if (BN8, BN9..BN48) = (0,1,0,1,0,1,0,0,1,1,1,1,1,0,0,0,1,0,0,0,0,1,1,0,0,0,1,0,1,1,1,0,0,1,0,0,1,1,0,1)</p> <p>22 if (BN8, BN9..BN48) = (1,1,1,0,1,1,1,1,0,0,1,0,0,1,1,1,0,1,0,1,0,1,1,0,0,0,0,0,1,1,0,1,1,0,1,1,1,0,1,1,1)</p>
12	<p>Detected Mod scheme is the most recently detected modulation scheme. The returned value is as follows:</p> <p>0 for GMSK 1 for Normal Burst (NB) 8PSK 2 for NB 16QAM 3 for NB 32QAM 11 for higher symbol rate burst (HB) QPSK 12 for HB 16QAM 13 for HB 32QAM</p>
13	Estimated Carrier power (ECP) in dBm
14	<p>Time Offset Power Results in dB</p> <p>If averaged number N = 1, the power measured and calculated at Offset Times relative to the mean power across the useful part of the burst.</p> <p>If averaged number N > 1, Time Offset Results return the limit margin worst case results. That is, 12 time offset results of the burst which has the worst limit margin are returned.</p> <p>12 Time Offsets can be set by SCPI commands.</p>

EDGE Error Vector Magnitude (EVM)

This section provides the remote control SCPI commands for the EDGE Error Vector Magnitude (EVM) measurement from within the List Sequencer. This measurement is available only if you have the GSM/EDGE measurement application licensed on the test set.

For more detailed information about the EDGE EVM measurement, refer to the online help associated with the GSM/EDGE measurement application, which is also available in PDF format (“User’s and Programmer’s Reference”) on the Keysight website, www.keysight.com/find/e6650a.

You can also refer to the measurement guide for the X-series GSM/EDGE measurement application, which is available on the Keysight website, www.keysight.com/find/mxa.

EDGE EVM measurement SCPI commands

There is a set of SCPI commands available to program the EDGE EVM measurement when it is used in the GSM/EDGE mode. To set up the GSM measurements from within the Sequence Analyzer mode you need to prefix the SCPI commands with `LSEQuencer:EDGE`. For example, the `[:SENSe]:EEVM` part of the EVM SCPI commands are replaced with `[:SENSe]:LSEQuencer:EDGE:EEVM`.

The following commands are used to set up the EVM measurement.

```
[:SENSe]:LSEQuencer:EDGE:EEVM:BSYNc:SOURce
:CALCulate:LSEQuencer:EDGE:EEVM:LIMit:TEST[:STATe} OFF|ON|0|1
:CALCulate:LSEQuencer:EDGE:EEVM:LIMit:TYPE
:CALCulate:LSEQuencer:EDGE:EEVM:LIMit:BTS:NORMal:REVM
:CALCulate:LSEQuencer:EDGE:EEVM:LIMit:BTS:EXTReme:REVM
:CALCulate:LSEQuencer:EDGE:EEVM:LIMit:MS:NORMal:REVM
:CALCulate:LSEQuencer:EDGE:EEVM:LIMit:MS:EXTReme:REVM
:CALCulate:LSEQuencer:EDGE:EEVM:LIMit:BTS:NORMal:REVM:NSRate
:CALCulate:LSEQuencer:EDGE:EEVM:LIMit:BTS:EXTReme:REVM:NSRate
:CALCulate:LSEQuencer:EDGE:EEVM:LIMit:MS:NORMal:REVM:NSRate
:CALCulate:LSEQuencer:EDGE:EEVM:LIMit:MS:EXTReme:REVM:NSRate
:CALCulate:LSEQuencer:EDGE:EEVM:LIMit:BTS:NORMal:REVM:HSRate
:CALCulate:LSEQuencer:EDGE:EEVM:LIMit:BTS:EXTReme:REVM:HSRate
:CALCulate:LSEQuencer:EDGE:EEVM:LIMit:MS:NORMal:REVM:HSRate
:CALCulate:LSEQuencer:EDGE:EEVM:LIMit:MS:EXTReme:REVM:HSRate
:CALCulate:LSEQuencer:EDGE:EEVM:LIMit:BTS:NORMal:PEVM
:CALCulate:LSEQuencer:EDGE:EEVM:LIMit:BTS:EXTReme:PEVM
:CALCulate:LSEQuencer:EDGE:EEVM:LIMit:MS:NORMal:PEVM
:CALCulate:LSEQuencer:EDGE:EEVM:LIMit:MS:EXTReme:PEVM
```

:CALCulate:LSEQuencer:EDGE:EEVM:LIMit:BTS:NORMal:EVMP95
:CALCulate:LSEQuencer:EDGE:EEVM:LIMit:BTS:EXTRemE:EVMP95
:CALCulate:LSEQuencer:EDGE:EEVM:LIMit:MS:NORMal:EVMP95
:CALCulate:LSEQuencer:EDGE:EEVM:LIMit:MS:EXTRemE:EVMP95
:CALCulate:LSEQuencer:EDGE:EEVM:LIMit:BTS:NORMal:IQOOffset
:CALCulate:LSEQuencer:EDGE:EEVM:LIMit:BTS:EXTRemE:IQOOffset
:CALCulate:LSEQuencer:EDGE:EEVM:LIMit:MS:NORMal:IQOOffset
:CALCulate:LSEQuencer:EDGE:EEVM:LIMit:MS:EXTRemE:IQOOffset
:CALCulate:LSEQuencer:EDGE:EEVM:LIMit:BTS:NORMal:FERRor
:CALCulate:LSEQuencer:EDGE:EEVM:LIMit:BTS:EXTRemE:FERRor
:CALCulate:LSEQuencer:EDGE:EEVM:LIMit:MBTS:NORMal:FERRor
:CALCulate:LSEQuencer:EDGE:EEVM:LIMit:MBTS:EXTRemE:FERRor
:CALCulate:LSEQuencer:EDGE:EEVM:LIMit:PBTS:NORMal:FERRor
:CALCulate:LSEQuencer:EDGE:EEVM:LIMit:PBTS:EXTRemE:FERRor
:CALCulate:LSEQuencer:EDGE:EEVM:LIMit:MS:NORMal:FERRor
:CALCulate:LSEQuencer:EDGE:EEVM:LIMit:MS:EXTRemE:FERRor
[:SENSe]:LSEQuencer:EDGE:EEVM:DROop
[:SENSe]:LSEQuencer:EDGE:EEVM:FERRor:TRANge
[:SENSe]:LSEQuencer:EDGE:EEVM:BSYNC:PMODulation:ALIGnment

GSM/EDGE Programming Commands
EDGE Error Vector Magnitude (EVM)

EDGE EVM results

General Results

Index	Result Parameter
0	Overall pass/fail result shows the mask test result (0.0 = pass, 1.0 = fail, -1.0 not tested).
1	RMS EVM pass/fail result (0.0 = pass, 1.0 = fail)
2	Peak EVM pass/fail result (0.0 = pass, 1.0 = fail)
3	95%ile EVM pass/fail result (0.0 = pass, 1.0 = fail)
4	I/Q origin offset pass/fail result (0.0 = pass, 1.0 = fail)
5	Frequency error pass/fail result (0.0 = pass, 1.0 = fail)
6	RMS 95th %ile EVM pass/fail result (0.0 = pass, 1.0 = fail)
7	Average RMS EVM – a floating point number (in percent) of EVM over the entire measurement area.
8	Maximum RMS EVM – a floating point number (in percent) of highest EVM over the entire measurement area.
9	Average Peak EVM - a floating point number (in percent) of the average of the peak EVMs. Take the peak EVMs from each burst and average them together. If only one burst in measurement interval, then it returns the peak for the measurement interval
10	Maximum Peak EVM - a floating point number (in percent) of the maximum peak EVM. Take the peak EVMs from each burst and identify the highest peak. If only one burst in measurement interval, then it returns the peak for the measurement interval.
11	Symbol position of the peak EVM – an integer number of the symbol position where the peak EVM error is detected.
12	Average Magnitude error – a floating point number (in percent) of average magnitude error over the entire measurement area. If there is only one burst in the measurement interval, then it will return the error for the measurement interval.
13	Maximum Magnitude error – a floating point number (in percent) of maximum magnitude error over the entire measurement interval.
14	Average Phase error – a floating point number (in degree) of average phase error over the entire measurement interval.
15	Maximum Phase error – a floating point number (in degree) of maximum phase error over the entire measurement interval.
16	Average Frequency error – a floating point number (in Hz) of the frequency error in the measured signal.
17	Maximum Frequency error – a floating point number (in Hz) of the highest frequency error in the measured signal.

18	I/Q origin offset – a floating point number (in dB) of the I and Q error (magnitude squared) offset from the origin.
19	Amplitude Droop Error – a floating point number (in dB) of the amplitude droop measured across the 142 symbol burst.
20	Trigger to T0 - a floating-point number (in seconds) of the time interval between the trigger point to T0. T0 means the transition time from symbol 13 to symbol 14 of the midamble training Sequence for each time slot.
21	Timing Offset of AM/PM path - a floating number (in seconds) of the time interval between Amplitude Modulation path and Phase Modulation path.
22	Detected TSC is the most recently detected TSC. The returned value is 0~7 (Burst Type : Normal) if TSC detected. If TSC not detected, the returned value is -999.0. If Amptd or NONE (Power vs Time only) specified in Sync Type, the returned value is -999.0. In multi slot condition, the returned value is the detected TSC of the specified slot (Time Slot ON) or the first evaluated slot (Time Slot OFF).
23	Detected Mod Scheme (0:GMSK, 1:NB 8PSK, 2:NB 16QAM, 3:NB 32QAM, 11:HB QPAK, 12:HB 16QAM, 13:HB 32QAM) Note that value except for GMSK and 8PSK return only when U9071A-3FP (EDGE Evo license) is installed.

NOTE The following QPSK EVM results, which would be returned if the measurement were run in the GSM/EDGE measurement mode, are not returned when the measurement is run in Sequence Analyzer mode:

- Unprocessed I/Q Trace Data
 - EVM Vector Trace
 - Magnitude Error Vector Trace
 - Phase Error Vector Trace
 - I/Q Corrected Trace
 - Demodulated Data
 - I/Q Derotated Measured Data
 - Max Hold EVM Vector Trace & Min Hold EVM Vector Trace
 - Max Hold Magnitude Error Trace & Min Hold Magnitude Error Trace
 - Max Hold Phase Error Trace & Min Hold Phase Error Trace
-

IQ Imbalance Results

The IQ Imbalance result (a double) is a value in dB, calculated from Gain Imbalance and Quadrature Skew.

GSM/EDGE Programming Commands
EDGE Error Vector Magnitude (EVM)

IQ imbalance is part of the EDGE EVM results, but to preserve backwards compatibility with earlier versions of firmware it is not included in the general results list. It can be queried using the command:

```
:FETCh:LSEQuencer:ACQuire{1:512}:ASTep{1:1000}:MEASurement? EEVM,  
"IqImbalance"
```

For example,

```
:FETC:LSEQ:ACQ{1}:AST{1}:MEAS? EEVM, "IqImbalance"
```

EDGE Output RF Spectrum (ORFS)

This section provides the remote control SCPI commands for the EDGE Output RF Spectrum (ORFS) measurement from within the List Sequencer. This measurement is available only if you have the GSM/EDGE measurement application licensed on the test set.

For more detailed information about the EDGE ORFS measurement, refer to the online help associated with the GSM/EDGE measurement application, which is also available in PDF format (“User’s and Programmer’s Reference”) on the Keysight website, www.keysight.com/find/e6650a.

You can also refer to the measurement guide for the X-series GSM/EDGE measurement application, which is available on the Keysight website, www.keysight.com/find/mxa.

EDGE ORFS measurement SCPI commands

There is a set of SCPI commands available to program the EDGE ORFS measurement when it is used in the GSM/EDGE mode. To set up the GSM measurements from within the Sequence Analyzer mode you need to prefix the SCPI commands with `LSEQuencer:EDGE`. For example, the `[:SENSe]:EORFSpectrum` part of the EDGE ORFS SCPI commands are replaced with `[:SENSe]:LSEQuencer:EDGE:EORFSpectrum`.

The following commands are used to set up the ORFS measurement.

```
[:SENSe]:LSEQuencer:EDGE:EORFSpectrum:TYPE
MODulation|MSWitching|SWITching|FFModulation
```

```
[:SENSe]:LSEQuencer:EDGE:EORFSpectrum:MEASure MULTiple|SINGLE|SWEPT
```

```
[:SENSe]:LSEQuencer:EDGE:EORFSpectrum:LIST:SElect CUSTom|SHORT|STANDARD
```

```
[:SENSe]:LSEQuencer:EDGE:EORFSpectrum:OFRequency <freq>
```

```
[:SENSe]:LSEQuencer:EDGE:EORFSpectrum:WBNoise ON|OFF|1|0
```

```
[:SENSe]:LSEQuencer:EDGE:EORFSpectrum:BANDwidth[:RESolution]:MODulation:CARR
ier <freq>
```

```
[:SENSe]:LSEQuencer:EDGE:EORFSpectrum:BANDwidth[:RESolution]:MODulation:OFFS
et:CLOSe <freq>
```

```
[:SENSe]:LSEQuencer:EDGE:EORFSpectrum:BANDwidth[:RESolution]:MODulation:OFFS
et:FAR <freq>
```

```
[:SENSe]:LSEQuencer:EDGE:EORFSpectrum:BANDwidth[:RESolution]:SWITching:CARRi
er <freq>
```

```
[:SENSe]:LSEQuencer:EDGE:EORFSpectrum:BANDwidth[:RESolution]:SWITching:OFFSe
t:CLOSe <freq>
```

```
[:SENSe]:LSEQuencer:EDGE:EORFSpectrum:BANDwidth[:RESolution]:SWITching:OFFSe
t:FAR <freq>
```

```
[:SENSe]:LSEQuencer:EDGE:EORFSpectrum:LIST:MODulation[:FREQuency] <freq>
```

```
[:SENSe]:LSEQuencer:EDGE:EORFSpectrum:LIST:MODulation:BANDwidth <freq>
```

GSM/EDGE Programming Commands
EDGE Output RF Spectrum (ORFS)

```
[ :SENSE ] :LSEQuencer:EDGE:EORFSpectrum:LIST:MODulation:LOFFset [ :RCARrier ]  
<rel_ampl>
```

```
[ :SENSE ] :LSEQuencer:EDGE:EORFSpectrum:LIST:MODulation:LOFFset:ABSolute  
<rel_ampl>
```

```
[ :SENSE ] :LSEQuencer:EDGE:EORFSpectrum:LIST:MODulation:APPLY  
RELative | BOTH | ABSolute, ...
```

```
[ :SENSE ] :LSEQuencer:EDGE:EORFSpectrum:LIST:SWITching [ :FREQuency ] <freq> ., ...
```

```
[ :SENSE ] :LSEQuencer:EDGE:EORFSpectrum:LIST:SWITching:BANDwidth <freq> ., ...
```

```
[ :SENSE ] :LSEQuencer:EDGE:EORFSpectrum:LIST:SWITching:LOFFset [ :RCARrier ]  
<rel_ampl> ., ...
```

```
[ :SENSE ] :LSEQuencer:EDGE:EORFSpectrum:LIST:SWITching:LOFFset:ABSolute  
<rel_ampl> ., ...
```

```
[ :SENSE ] :LSEQuencer:EDGE:EORFSpectrum:LIST:SWITching:APPLY  
RELative | BOTH | ABSolute, ...
```

```
[ :SENSE ] :LSEQuencer:EDGE:EORFSpectrum:MODulation:RPOWER <ampl>
```

```
[ :SENSE ] :LSEQuencer:EDGE:EORFSpectrum:SWITching:RPOWER <ampl>
```

EDGE ORFS results

Index	Result Parameter
0	Overall pass/fail result (0.0 = pass, 1.0 = fail, -1.0: Not tested)
1	<p>Returns a list of comma-separated values for the modulation spectrum at all the offsets (lower and upper.). This is followed by the switching transient results at all the offsets (lower and upper). The carrier is considered offset zero (0) and is the first set of results sent. Four values are provided for each of the offsets (including the carrier), in this order:</p> <ol style="list-style-type: none"> 1. Negative offset(a) - power relative to carrier (dB) 2. Negative offset(a) - absolute average power (dBm) 3. Positive offset(a) - power relative to carrier (dB) 4. Positive offset(a) - absolute average power (dBm) <p>Values for all possible offsets are sent. Zeros are sent for offsets that have not been defined. The total number of values sent (120) = (4 results/offset) * (15 offsets) * (2 measurement types - modulation & switching)</p> <p>Carrier - modulation measurement values Offset 1 - modulation measurement values and so on ~ Offset 14 - modulation measurement values Carrier - switching transients measurement values Offset 1 - switching transients measurement values ~ Offset 14 - switching transients measurement values ...</p>

2	<p>Returns a list of relative level to the test limit, the relative test limit and the absolute test limit for all the offset frequencies. The relative level to the test limit is returned for both lower and upper offsets. Four values are returned for each offset in the following order:</p> <ol style="list-style-type: none"> 1. Relative level to the test limit (dB) at the negative offset frequency 2. Relative level to the test limit (dB) at the positive offset frequency 3. Relative test limit used (dB) 4. Absolute test limit used (dBm) <p>Values for all possible offsets are returned.</p> <p>The carrier frequency is considered offset zero (0.0 Hz) and is the first set of values returned.</p> <p>Zeros are returned for offsets that have not been defined.</p> <p>Zeros are returned for the measurement that was not performed. For example, if Meas Type is Modulation, all switching transient measurement results are 0.0.</p> <p>The total number of values returned is:</p> $120 = (4 \text{ results / offset}) * (15 \text{ offset frequencies}) * (2 \text{ measurement types})$ <p>Carrier (Offset A) – modulation measurement results Offset 1 (Offset B) - modulation measurement results Offset 14 (Offset O) - modulation measurement results Carrier (Offset A)– switching transients measurement results Offset 1 (Offset B) – switching transients measurement results Offset 14 (Offset O) – switching transients measurement results</p>
3	<p>PCL is the Power Control Level that is determined by the Transmit power and used to determine the limits.</p>

EDGE Loopback BER

This section provides the remote control SCPI commands for the EDGE Loopback BER measurement from within the List Sequencer. This measurement is available only if you have the GSM/EDGE measurement application licensed on the test set.

The EDGE Loopback BER measurement is based on the EDGE EVM measurement, and uses remote commands associated with that measurement.

For more detailed information about the EDGE EVM measurement, refer to the online help associated with the GSM/EDGE measurement application, which is also available in PDF format (“User’s and Programmer’s Reference”) on the Keysight website, www.keysight.com/find/e6650a.

EDGE Loopback BER measurement SCPI commands

The following commands are used to set up the Loopback BER measurement from within the sequence analyzer mode.

```
[ :SENSe] :LSEQuencer :EDGE :EEVM :BSYNc :SOURce
```

```
[ :SENSe] :LSEQuencer :EDGE :EEVM :DROop
```

```
[ :SENSe] :LSEQuencer :EDGE :EEVM :FERRor :TRANge
```

```
[ :SENSe] :LSEQuencer :EDGE :EEVM :BSYnc :PMODulation :ALIGnment
```

Loopback BER results

Index	Result Parameter
0	Loopback bit error ratio.
1	Total tested bit number.
2	Failed bit number.
3	Reserve.

GSM/EDGE Programming Commands
EDGE Loopback BER

14 W-CDMA Programming Commands

This chapter lists all the commands used to set up the W-CDMA measurements from within the List Sequencer.

NOTE See also: mode parameters related to W-CDMA, as described in [“Mode and Measurement Parameters”](#) on page 52.

The chapter topics are:

- [Adjacent Channel Power \(ACP\)](#)
- [Spectrum Emissions Mask \(SEM\)](#)
- [Occupied Bandwidth \(OBW\)](#)
- [Modulation Accuracy](#)
- [QPSK EVM](#)
- [Code Domain Power \(CDP\)](#)
- [Phase Discontinuity](#)
- [Loopback BER](#)

Adjacent Channel Power (ACP)

This section provides the remote control SCPI commands for the W-CDMA Adjacent Channel Power (ACP) measurement from within the List Sequencer. This measurement is available only if you have the W-CDMA measurement application licensed on the test set.

For more detailed information about the ACP measurement, refer to the online help associated with the W-CDMA measurement application, which is also available in pdf format (User's and Programmer's Reference) on the web and also available in pdf format on the Keysight website, www.keysight.com/find/e6650a.

You can also refer to the measurement guide for the X-series W-CDMA measurement application, which is available on the Keysight website, www.keysight.com/find/mxa.

Adjacent Channel Power (ACP) measurement SCPI commands

There is a set of SCPI commands available to program the W-CDMA ACP measurement when it is used in the W-CDMA mode. To set up the W-CDMA measurements from within the Sequence Analyzer mode you need to prefix the SCPI commands with `LSEQuencer:WCDMa`. For example, the `[:SENSe]:ACPower` part of the ACP SCPI commands are replaced with `[:SENSe]:LSEQuencer:WCDMa:ACPower`.

The following commands are used to set up the ACP measurement.

```
[:SENSe]:LSEQuencer:WCDMa:ACPower:BANDwidth[:RESolution]
[:SENSe]:LSEQuencer:WCDMa:ACPower:BANDwidth:SHAPE
[:SENSe]:LSEQuencer:WCDMa:ACPower:BANDwidth:TYPE
[:SENSe]:LSEQuencer:WCDMa:ACPower:CARRIER[1]|2:COUNT
[:SENSe]:LSEQuencer:WCDMa:ACPower:CARRIER[1]|2:REFERENCE
[:SENSe]:LSEQuencer:WCDMa:ACPower:CARRIER[1]|2:RCARRIER:AUTO
[:SENSe]:LSEQuencer:WCDMa:ACPower:CARRIER[1]|2:RCFREQUENCY
[:SENSe]:LSEQuencer:WCDMa:ACPower:CARRIER[1]|2:RCFREQUENCY:AUTO
[:SENSe]:LSEQuencer:WCDMa:ACPower:CARRIER[1]|2[:POWER]
[:SENSe]:LSEQuencer:WCDMa:ACPower:CARRIER[1]|2:AUTO[:STATE]
[:SENSe]:LSEQuencer:WCDMa:ACPower:CARRIER[1]|2:CPSD
[:SENSe]:LSEQuencer:WCDMa:ACPower:CARRIER[1]|2:LIST:COUPLE
[:SENSe]:LSEQuencer:WCDMa:ACPower:CARRIER[1]|2:LIST:PPRESENT
[:SENSe]:LSEQuencer:WCDMa:ACPower:CARRIER[1]|2:LIST:WIDTH
[:SENSe]:LSEQuencer:WCDMa:ACPower:CARRIER[1]|2:LIST:BANDwidth
[:INTegration]
[:SENSe]:LSEQuencer:WCDMa:ACPower:CARRIER[1]|2:LIST:METHoD
[:SENSe]:LSEQuencer:WCDMa:ACPower:CARRIER[1]|2:LIST:FILTer:ALPHA
```

[:SENSE] :LSEQuencer :WCDMa :ACPower :OFFSet [1] | 2 :LIST [:FREQuency]
[:SENSe] :LSEQuencer :WCDMa :ACPower :OFFSet [1] | 2 :LIST :STAtE
[:SENSe] :LSEQuencer :WCDMa :ACPower :OFFSet [1] | 2 :LIST :BANDwidth
[:SENSe] :LSEQuencer :WCDMa :ACPower :OFFSet [1] | 2 :LIST :BANDwidth :RESolution
[:SENSe] :LSEQuencer :WCDMa :ACPower :OFFSet [1] | 2 :LIST :BANDwidth
:RESolution :AUTO
[:SENSe] :LSEQuencer :WCDMa :ACPower :OFFSet [1] | 2 :LIST :BANDwidth :SHAPE
[:SENSe] :LSEQuencer :WCDMa :ACPower :OFFSet [1] | 2 :LIST :BANDwidth :TYPE
[:SENSe] :LSEQuencer :WCDMa :ACPower :OFFSet [1] | 2 :LIST :ABSolute
[:SENSe] :LSEQuencer :WCDMa :ACPower :OFFSet [1] | 2 :LIST :TEST
[:SENSe] :LSEQuencer :WCDMa :ACPower :OFFSet [1] | 2 :LIST :RCARrier
[:SENSe] :LSEQuencer :WCDMa :ACPower :OFFSet [1] | 2 :LIST :RPSDensity

W-CDMA Programming Commands
 Adjacent Channel Power (ACP)

ACP results

Index	Result Parameter
0	<p>Pass/Fail results - returns 24 scalar values of the pass/fail (0.0 = pass, 1.0 = fail) determined by testing relative to the reference carrier and by testing the absolute power limit of the offset frequencies (measured as total power in dBm)</p> <p>Lower Offset A - relative limit test result</p> <p>Lower Offset A - absolute limit test result</p> <p>Upper Offset A - relative limit test result</p> <p>Upper Offset A - absolute limit test result</p> <p>Lower Offset B - relative limit test result</p> <p>Lower Offset B - absolute limit test result</p> <p>Upper Offset B - relative limit test result</p> <p>Upper Offset B - absolute limit test result</p> <p>...</p> <p>Lower Offset F - relative limit test result</p> <p>Lower Offset F - absolute limit test result</p> <p>Upper Offset F - relative limit test result</p> <p>Upper Offset F - absolute limit test result</p>
1	<p>Carrier Powers - returns 3 scalar values representing overall pass/fail, carrier power, and reference carrier power.</p> <p>Overall Pass/Fail</p> <p>Total Carrier Power</p> <p>Reference Carrier Power</p> <p>If Meas Type is Total Power Reference, these results are returned in units of dBm. If Meas Type is Power Spectral Density Reference, these results are returned in units of dBm/Hz or dBm/MHz.</p>

2	<p>Power Results</p> <p>Channel (1) - relative power</p> <p>Channel (1) - absolute power</p> <p>Channel (1) - relative power</p> <p>Channel (1) - absolute power</p> <p>...</p> <p>Channel (1) - relative power</p> <p>Channel (1) - absolute power</p> <p>Lower Offset A - relative power</p> <p>Lower Offset A - absolute power</p> <p>Upper Offset A - relative power</p> <p>Upper Offset A - absolute power</p> <p>Lower Offset B - relative power</p> <p>Lower Offset B - absolute power</p> <p>Upper Offset B - relative power</p> <p>Upper Offset B - absolute power</p> <p>...</p> <p>Lower Offset F - relative power</p> <p>Lower Offset F - absolute power</p> <p>Upper Offset F - relative power</p> <p>Upper Offset F - absolute power</p> <p>If Meas Type is Total Power Reference, these results are returned in units of dBm. If Meas Type is Power Spectral Density Reference, these results are returned in units of dBm/Hz or dBm/MHz.</p>
---	--

Spectrum Emissions Mask (SEM)

This section provides the remote control SCPI commands for the W-CDMA Spectrum Emissions Mask (SEM) measurement from within the List Sequencer. This measurement is available only if you have the W-CDMA measurement application licensed on the test set.

For more detailed information about the SEM measurement, refer to the online help associated with the W-CDMA measurement application, which is also available in pdf format (User's and Programmer's Reference) on the web and available in pdf format on the Keysight website, www.keysight.com/find/e6650a.

You can also refer to the measurement guide for the X-series W-CDMA measurement application, which is available on the Keysight website, www.keysight.com/find/mxa.

SEM measurement SCPI commands

There is a set of SCPI commands available to program the W-CDMA SEM measurement when it is used in the W-CDMA mode. To set up the W-CDMA measurements from within the Sequence Analyzer mode you need to prefix the SCPI commands with `LSEQuencer:WCDMa`. For example, the `[:SENSe]:SEMAsk` part of the SEM SCPI commands are replaced with `[:SENSe]:LSEQuencer:WCDMa:SEMAsk`.

The following commands are used to set up the SEM measurement.

```
[:SENSe]:LSEQuencer:WCDMa:SEMAsk:TYPE
[:SENSe]:LSEQuencer:WCDMa:SEMAsk:BANDwidth[1]|2:INTegration
[:SENSe]:LSEQuencer:WCDMa:SEMAsk:FREQuency[1]|2:SPAN
[:SENSe]:LSEQuencer:WCDMa:SEMAsk:BANDwidth[1]|2[:RESolution]
[:SENSe]:LSEQuencer:WCDMa:SEMAsk:BANDwidth[1]|2[:RESolution]:AUTO
[:SENSe]:LSEQuencer:WCDMa:SEMAsk:CARRier[:POWER]
[:SENSe]:LSEQuencer:WCDMa:SEMAsk:CARRier:AUTO[:STATE]
[:SENSe]:LSEQuencer:WCDMa:SEMAsk:CARRier:CPSD
[:SENSe]:LSEQuencer:WCDMa:SEMAsk:CARRier:PEAK[:POWER]
[:SENSe]:LSEQuencer:WCDMa:SEMAsk:OFFSet[1]|2:LIST:FREQuency:START
[:SENSe]:LSEQuencer:WCDMa:SEMAsk:OFFSet[1]|2:LIST:STATE
[:SENSe]:LSEQuencer:WCDMa:SEMAsk:OFFSet[1]|2:LIST:FREQuency:STOP
[:SENSe]:LSEQuencer:WCDMa:SEMAsk:OFFSet[1]|2:LIST:SIDE
[:SENSe]:LSEQuencer:WCDMa:SEMAsk:OFFSet[1]|2:LIST:BANDwidth[:RESolution]
[:SENSe]:LSEQuencer:WCDMa:SEMAsk:OFFSet[1]|2:LIST:BANDwidth[:RESolution]:AUTO
[:SENSe]:LSEQuencer:WCDMa:SEMAsk:OFFSet[1]|2:LIST:BANDwidth:IMULTi
[:SENSe]:LSEQuencer:WCDMa:SEMAsk:OFFSet[1]|2:LIST:START:ABSolute
```

```
[ :SENSe ] :LSEQuencer :WCDMa :SEMAsk :OFFSet [ 1 ] | 2 :LIST :STOP :ABSolute  
[ :SENSe ] :LSEQuencer :WCDMa :SEMAsk :OFFSet [ 1 ] | 2 :LIST :STOP :ABSoluteCOUPle  
[ :SENSe ] :LSEQuencer :WCDMa :SEMAsk :OFFSet [ 1 ] | 2 :LIST :STARt :RCARrier  
[ :SENSe ] :LSEQuencer :WCDMa :SEMAsk :OFFSet [ 1 ] | 2 :LIST :STOP :RCARrier  
[ :SENSe ] :LSEQuencer :WCDMa :SEMAsk :OFFSet [ 1 ] | 2 :LIST :STOP :RCARrier :COUPle  
[ :SENSe ] :LSEQuencer :WCDMa :SEMAsk :OFFSet [ 1 ] | 2 :LIST :TEST  
[ :SENSe ] :LSEQuencer :WCDMa :SEMAsk :FILTer [ :RRC ] [ :STATe ]  
[ :SENSe ] :LSEQuencer :WCDMa :SEMAsk :FILTer [ :RRC ] :ALPHa ]  
[ :SENSe ] :LSEQuencer :WCDMa :SEMAsk :LIMits  
[ :SENSe ] :LSEQuencer :WCDMa :SEMAsk :LIMits :TYPE  
:TRACe :LSEQuencer :WCDMa :SEMAsk :TYPE
```

W-CDMA Programming Commands
Spectrum Emissions Mask (SEM)

SEM results

Index	Result Parameter
0	Overall Pass/Fail result shows the mask test result (0 = pass, 1 = fail, -1 not tested)
1	<p>Main Results</p> <ol style="list-style-type: none"> 1. Absolute power at center frequency (reference) area (dBm) 2. Peak Frequency in the center frequency (reference) area (Hz) 3. Relative integrated power on the negative offset A (dBc) 4. Absolute integrated power on the negative offset A (dBm or dBm/Hz) 5. Relative peak power on the negative offset A (dBc) 6. Absolute peak power on the negative offset A (dBm or dBm/Hz) 7. Peak power offset frequency from the center frequency in the negative offset A (Hz) 8. Relative integrated power on the positive offset A (dBc) 9. Absolute integrated power on the positive offset A (dBm or dBm/Hz) 10. Relative peak power on the positive offset A (dBc) 11. Absolute peak power on the positive offset A (dBm or dBm/Hz) 12. Peak power offset frequency from the center frequency in the positive offset A (Hz) 13. Relative integrated power on the negative offset B (dBc) <p>...</p> <ol style="list-style-type: none"> 61. Absolute peak power on the positive offset F (dBm or dBm/Hz) 62. Peak power offset frequency from the center frequency in the positive offset F (Hz) 63. Minimum margin from limit line on the negative offset A (dB) 64. Minimum margin from limit line on the positive offset A (dB) 65. Minimum margin from limit line on the negative offset B (dB) 66. Minimum margin from limit line on the positive offset B (dB) 67. Minimum margin from limit line on the negative offset C (dB) 68. Minimum margin from limit line on the positive offset C (dB) 69. Minimum margin from limit line on the negative offset D (dB) 70. Minimum margin from limit line on the positive offset D (dB) 71. Minimum margin from limit line on the negative offset E (dB) 72. Minimum margin from limit line on the positive offset E (dB) 73. Minimum margin from limit line on the negative offset F (dB) 74. Minimum margin from limit line on the positive offset F (dB) <p>The unit for the absolute power results varies depending on the measurement type:</p> <p>If the measurement type is Total Power Reference, these results are expressed in dBm.</p> <p>If the measurement type is Power Spectral Density Reference, these results are expressed in dBm/Hz.</p>

Occupied Bandwidth (OBW)

This section provides the remote control SCPI commands for the Occupied Bandwidth (OBW) measurement from within the List Sequencer. This measurement is available only if you have the W-CDMA measurement application licensed on the test set.

For more detailed information about the OBW measurement, refer to the online help associated with the W-CDMA measurement application, which is also available in PDF format (“User’s and Programmer’s Reference”) on the Keysight website, www.keysight.com/find/e6650a.

You can also refer to the measurement guide for the X-series W-CDMA measurement application, which is available on the Keysight website, www.keysight.com/find/mxa.

OBW measurement SCPI commands

There is a set of SCPI commands available to program the W-CDMA OBW measurement when it is used in the W-CDMA mode. To set up the W-CDMA measurements from within the Sequence Analyzer mode you need to prefix the SCPI commands with `LSEQuencer:WCDMa`. For example, the `[:SENSe]:OBWidth` part of the OBW SCPI commands are replaced with `[:SENSe]:LSEQuencer:WCDMa:OBWidth`.

The following commands are used to set up the OBW measurement.

```
[:SENSe]:LSEQuencer:LTETdd:OBWidth:BANDwidth[:RESolution]
```

```
[:SENSe]:LSEQuencer:LTETdd:OBWidth:BANDwidth:SHAPE
```

```
[:SENSe]:LSEQuencer:LTETdd:OBWidth:PERCent
```

```
[:SENSe]:LSEQuencer:LTETdd:OBWidth:XDB
```

```
CALCulate: [SENSe]:LSEQuencer:LTETdd:OBWidth:LIMit:FBLimit
```

```
CALCulate: [SENSe]:LSEQuencer:LTETdd:OBWidth:LIMit[:TEST]
```

```
[:SENSe]:LSEQuencer:LTETdd:OBWidth:FREQuency:SPAN
```

```
[:SENSe]:LSEQuencer:LTETdd:OBWidth:FREQuency:SPAN:FULL
```

```
[:SENSe]:LSEQuencer:LTETdd:OBWidth:FREQuency:SPAN:PREVIOUS
```

OBW results

Index	Result Parameter
0	Overall Pass/Fail
1	Main Results 1. Occupied Bandwidth (Hz) 2. Transmit Frequency Error (Hz) 3. x dB bandwidth (Hz)

Modulation Accuracy

This section provides the remote control SCPI commands for the W-CDMA Modulation Accuracy measurement from within the List Sequencer. This measurement is available only if you have the W-CDMA measurement application licensed on the test set.

For more detailed information about the Modulation Accuracy measurement, refer to the online help associated with the W-CDMA measurement application, which is also available in PDF format (“User’s and Programmer’s Reference”) on the Keysight website, www.keysight.com/find/e6650a.

You can also refer to the measurement guide for the X-series W-CDMA measurement application, which is available on the Keysight website, www.keysight.com/find/mxa.

Modulation Accuracy measurement SCPI commands

There is a set of SCPI commands available to program the W-CDMA modulation accuracy measurement when it is used in the W-CDMA mode. To set up the W-CDMA measurements from within the Sequence Analyzer mode you need to prefix the SCPI commands with `LSEQuencer:WCDMa`. For example, the `[:SENSe]:RHO` part of the modulation accuracy SCPI commands are replaced with `[:SENSe]:LSEQuencer:WCDMa:RHO`

The following commands are used to set up the modulation accuracy measurement.

```
[:SENSe]:LSEQuencer:WCDMa:RHO:CAPTure:TIME[:FRAME]
[:SENSe]:LSEQuencer:WCDMa:RHO:SWEep:OFFset
:CALCulate:LSEQuencer:WCDMa:RHO:LIMit:RMS
:CALCulate:LSEQuencer:WCDMa:RHO:LIMit:PEAK
:CALCulate:LSEQuencer:WCDMa:RHO:LIMit:RHO
:CALCulate:LSEQuencer:WCDMa:RHO:LIMit:CDERror
:CALCulate:LSEQuencer:WCDMa:RHO:LIMit:FERRor
:CALCulate:LSEQuencer:WCDMa:RHO:LIMit:CPICh[:BTS]:POWER
:CALCulate:LSEQuencer:WCDMa:RHO:LIMit:CPICh[:BTS]
[:SENSe]:LSEQuencer:WCDMa:RHO:SYNC[:BTS]
[:SENSe]:LSEQuencer:WCDMa:RHO:SYNC:SYMBOL:SRATE
[:SENSe]:LSEQuencer:WCDMa:RHO:SYNC:SYMBOL:SPRead
[:SENSe]:LSEQuencer:WCDMa:RHO:SYNC:MS
[:SENSe]:LSEQuencer:WCDMa:RHO:SYNC:SCRamble[:BTS]
[:SENSe]:LSEQuencer:WCDMa:RHO:SFORMat:MS
[:SENSe]:LSEQuencer:WCDMa:RHO:PRACH:SIGNature
[:SENSe]:LSEQuencer:WCDMa:RHO:SYNC:SCRamble[:BTS]:OFFSet
[:SENSe]:LSEQuencer:WCDMa:RHO:SYNC:SCRamble:MS
[:SENSe]:LSEQuencer:WCDMa:RHO:SYNC:SCRamble[:BTS]:TYPE
```

[:SENSe] :LSEQuencer :WCDMa :RHO :SBOundary [:BTS]
[:SENSe] :LSEQuencer :WCDMa :RHO :SBOundary :LIST [:BTS] :INIT
[:SENSe] :LSEQuencer :WCDMa :RHO :SBOundary :LIST [:BTS] :APPend
[:SENSe] :LSEQuencer :WCDMa :RHO :SBOundary :LIST [:BTS] :REPLace
[:SENSe] :LSEQuencer :WCDMa :RHO :SBOundary :LIST [:BTS] :CHANnel?
[:SENSe] :LSEQuencer :WCDMa :RHO :SBOundary :LIST [:BTS] :NCHannels?
[:SENSe] :LSEQuencer :WCDMa :RHO :SBOundary :LIST [:BTS] ;PRESet
[:SENSe] :LSEQuencer :WCDMa :RHO :SBOundary :MS
[:SENSe] :LSEQuencer :WCDMa :RHO :SBOundary :LIST :MS :INIT
[:SENSe] :LSEQuencer :WCDMa :RHO :SBOundary :LIST :MS :APPend
[:SENSe] :LSEQuencer :WCDMa :RHO :SBOundary :LIST :MS :REPLace
[:SENSe] :LSEQuencer :WCDMa :RHO :SBOundary :LIST :MS :CHANnel?
[:SENSe] :LSEQuencer :WCDMa :RHO :SBOundary :LIST :MS :NCHannels?
[:SENSe] :LSEQuencer :WCDMa :RHO :SSLot :NUMBER
[:SENSe] :LSEQuencer :WCDMa :RHO :SWEep :TIME :TRANSient
[:SENSe] :LSEQuencer :WCDMa :RHO :SPECTrum
:CALCulate :LSEQuencer :WCDMa :RHO :IQOffset :INCLude
:CALCulate :LSEQuencer :WCDMa :RHO :ASET :THReshold
:CALCulate :LSEQuencer :WCDMa :RHO :ASET :THReshold :AUTO
[:SENSe] :LSEQuencer :WCDMa :RHO :FILTer [:RRC] [:STATe]
[:SENSe] :LSEQuencer :WCDMa :RHO :FILTer [:RRC] :ALPHa
[:SENSe] :LSEQuencer :WCDMa :RHO :CRATe
:CALCulate :LSEQuencer :WCDMa :RHO :DTXBurst
[:SENSe] :LSEQuencer :WCDMa :RHO :MCEStimator
[:SENSe] :LSEQuencer :WCDMa :RHO :MCEStimator :TIMing
[:SENSe] :LSEQuencer :WCDMa :RHO :FERRor :TRANge
[:SENSe] :LSEQuencer :WCDMa :RHO :PICH :SPRead
[:SENSe] :LSEQuencer :WCDMa :RHO :MICH :SPRead

Modulation Accuracy results

Index	Result Parameter
0	Overall Pass/Fail Result shows the mask test result (0.0 = pass, 1.0 = fail, -1.0: Not tested)
1	RMS EVM pass/fail result (0.0 = pass, 1.0 = fail)
2	Peak EVM pass/fail result (0.0 = pass, 1.0 = fail)
3	Frequency Error pass/fail result (0.0 = pass, 1.0 = fail)
4	Rho pass/fail result (0.0 = pass, 1.0 = fail)
5	Peak Code Domain Error pass/fail result (0.0 = pass, 1.0 = fail)
6	RMS EVM (Average) is a floating point number (in percent) of EVM over the entire measurement area
7	Peak EVM (Peak Hold) is a floating point number (in percent) of the Peak EVM in the entire measurement area.
8	Magnitude Error (Average) is a floating point number (in percent) of the average magnitude error over the entire measurement area.
9	Phase Error (Average) is a floating point number (in degree) of the average phase error over the entire measurement area.
10	I/Q Origin Offset (Average) is a floating point number (in dB) of the I and Q error (magnitude squared) offset from the origin.
11	Frequency Error (Average) is a floating point number (in Hz) of the frequency error in the measured signal.
12	Rho (Average) is a floating point number of Rho.
13	Peak Code Domain Error (Peak Hold) is a floating point number (in dB) of the Peak Code Domain Error relative to the mean reference power.
14	Peak Code Domain Error Channel Number (Peak Hold) is the channel number in which the peak code domain error is detected.
15	Number of active channels.
16	Time Offset (Average) is a floating point number (in chips) of the pilot phase timing from the acquisition trigger point.
17	Total power over a slot (Average) is a floating point number (in dBm) of the total RF power over a measurement slot.
18	First Slot Number is an integer number of the first slot in Capture Interval. This is not averaged even if the averaging function is On. It is always the last cycle of the measurement.

19	<p>DPCCH Slot Format: (floating) If Sync Type is DPCCH, the DPCCH slot format value used for synchronization is returned.</p> <p>0.0: Slot Format 0 1.0: Slot Format 1 2.0: Slot Format 2 3.0: Slot Format 3 4.0: Slot Format 4 5.0: Slot Format 5</p> <p>If Sync Type is PRACH, the value returned is -999.0. In BTS mode, the value returned is -999.0.</p>
20	<p>Preamble Signature: (floating)</p> <p>BTS mode: The returned value is always -999.0.</p> <p>MS mode: In Preamble Signature auto-detection mode, the detected signature code number (from 0.0 to 15.0) is returned when the Sync Type is PRACH Message. In Preamble Signature manual setting mode, the returned value is the same as the parameter setting. When the Sync Type is not PRACH Message, the returned value is NAN.</p>
21	<p>Average Peak EVM (Average Peak) is a floating point number (in percent) of the averaging for Peak EVM readings on each slot over the entire measurement area.</p>

QPSK EVM

This section provides the remote control SCPI commands for the TD-SCDMA Code Domain Power (CDP) measurement from within the List Sequencer. This measurement is available only if you have the TD-SCDMA measurement application licensed on the test set.

For more detailed information about the QPSK EVM measurement, refer to the online help associated with the TD-SCDMA measurement application, which is also available in PDF format (“User’s and Programmer’s Reference”) on the Keysight website, www.keysight.com/find/e6650a.

You can also refer to the measurement guide for the X-series TD-SCDMA measurement application, which is available on the Keysight website, www.keysight.com/find/mxa.

QPSK EVM measurement SCPI commands

There is a set of SCPI commands available to program the TD-SCDMA QPSK EVM measurement when it is used in the TD-SCDMA mode. To set up the TD-SCDMA measurements from within the Sequence Analyzer mode you need to prefix the SCPI commands with LSEQuencer:WCDMa. For example, the [:SENSe]:EVMQpsk part of the QPSK EVM SCPI commands are replaced with [:SENSe]:LSEQuencer:WCDMa:EVMQpsk.

The following commands are used to set up the QPSK EVM measurement.

```
[:SENSe]:LSEQuencer:WCDMa:EVMQpsk:BANDwidth[:RESolution]
[:SENSe]:LSEQuencer:WCDMa:EVMQpsk:BANDwidth:SHAPE
:CALCulate:LSEQuencer:WCDMa:EVMQpsk:LIMit:RMS
:CALCulate:LSEQuencer:WCDMa:EVMQpsk:LIMit:FERRor
[:SENSe]:LSEQuencer:WCDMa:EVMQpsk:MEAS:OFFSet
[:SENSe]:LSEQuencer:WCDMa:EVMQpsk:MEAS:LENGth
[:SENSe]:LSEQuencer:WCDMa:EVMQpsk:SPECTrum
[:SENSe]:LSEQuencer:WCDMa:EVMQpsk:FILTer[:RRC][:STATE]
[:SENSe]:LSEQuencer:WCDMa:EVMQpsk:FILTER:ALPHA
[:SENSe]:LSEQuencer:WCDMa:EVMQpsk:CRATE
```

QPSK EVM results

Index	Result Parameter
0	Overall Pass/Fail Result shows the mask test result (0.0 = pass, 1.0 = fail, -1.0: Not tested)
1	RMS EVM pass/fail result (1.0 = fail, 0.0 = pass) Returns the result of whether the RMS EVM passed the limit set in the measurement setup.
2	Peak EVM pass/fail result (1.0 = fail, 0.0 = pass) Returns the result of whether the Peak EVM passed the limit set in the measurement setup.
3	Magnitude Error pass/fail result (1.0 = fail, 0.0 = pass) Returns the result of whether the Magnitude Error passed the limit set in the measurement setup.
4	Phase Error pass/fail result (1.0 = fail, 0.0 = pass) Returns the result of whether the Phase Error passed the limit set in the measurement setup.
5	Frequency Error pass/fail result (1.0 = fail, 0.0 = pass) Returns the result of whether the Freq Error passed the limit set in the measurement setup.
6	IQ Original Offset pass/fail result (1.0 = fail, 0.0 = pass) Returns the result of whether the IQ Original Offset passed the limit set in the measurement setup.
7	RMS EVM (Average) is a floating point number (in percent) of EVM over the entire measurement interval.
8	RMS EVM maximum is the maximum RMS EVM over the average group. If averaging is off, then it returns result for the measurement interval.
9	Peak EVM is a floating point number (in percent) of the Peak EVM in the measurement interval.
10	Peak EVM maximum is the maximum Peak EVM over the average group. If averaging is off, then it returns result for the measurement interval.
11	Magnitude Error is a floating point number (in percent) of averaged magnitude error over the entire measurement interval.
12	Magnitude Error maximum is a floating point number over the average group. If averaging is off, then it returns result for the measurement interval.
13	Phase Error is a floating point number (in degrees) of the averaged phase error over the entire measurement interval.
14	Phase Error maximum is the maximum Phase Error over the average group. If averaging is off, then it returns result for the measurement interval.
15	Frequency Error is a floating point number (in Hz) of the frequency error in the measured signal.
16	Frequency Error maximum is the maximum frequency error over the average group. If averaging is off, then it returns result for the measurement interval.
17	I/Q Origin Offset is a floating point number (in dB) of the I and Q error (magnitude squared) offset from the origin.

NOTE The following QPSK EVM results, which would be returned if the measurement were run in the W-CDMA measurement mode, are not returned when the measurement is run in Sequence Analyzer mode:

- Unprocessed I/Q Trace Data
 - EVM Trace
 - Magnitude Error Trace
 - Phase Error Trace
 - Corrected Measured Trace
-

Code Domain Power (CDP)

This section provides the remote control SCPI commands for the W-CDMA Code Domain Power (CDP) measurement from within the List Sequencer. This measurement is available only if you have the W-CDMA measurement application licensed on the test set.

For more detailed information about the CDP measurement, refer to the online help associated with the W-CDMA measurement application, which is also available in PDF format (“User’s and Programmer’s Reference”) on the Keysight website, www.keysight.com/find/e6650a.

You can also refer to the measurement guide for the X-series W-CDMA measurement application, which is available on the Keysight website, www.keysight.com/find/mxa.

CDP measurement SCPI commands

There is a set of SCPI commands available to program the W-CDMA CDP measurement when it is used in the W-CDMA mode. To set up the W-CDMA measurements from within the Sequence Analyzer mode you need to prefix the SCPI commands with LSEQuencer:WCDMa. For example, the [:SENSE]:CDPower part of the CDP SCPI commands are replaced with:

```
[ :SENSE ] :LSEQuencer:WCDMa:CDPower
```

The following commands are used to set up the CDP measurement.

```
:CALCulate:LSEQuencer:WCDMa:CDPower:TYPE
:CALCulate:LSEQuencer:WCDMa:CDPower:SRATE
:CALCulate:LSEQuencer:WCDMa:CDPower:SPRead
:CALCulate:LSEQuencer:WCDMa:CDPower:AXIS[:MS]
[ :SENSE ] :LSEQuencer:WCDMa:CDPower:SYNC:MS
[ :SENSE ] :LSEQuencer:WCDMa:CDPower:SFORmat:MS
[ :SENSE ] :LSEQuencer:WCDMa:CDPower:PRACH:SIGNature
[ :SENSE ] :LSEQuencer:WCDMa:CDPower:SYNC:SCRamble:MS
[ :SENSE ] :LSEQuencer:WCDMa:CDPower:DPCH:MS:CONFigure
[ :SENSE ] :LSEQuencer:WCDMa:CDPower:SBOundary:MS
[ :SENSE ] :LSEQuencer:WCDMa:CDPower:SBOundary:LIST:MS:INIT
[ :SENSE ] :LSEQuencer:WCDMa:CDPower:SBOundary:LIST:MS:APPend
[ :SENSE ] :LSEQuencer:WCDMa:CDPower:SBOundary:LIST:MS:REPLace
[ :SENSE ] :LSEQuencer:WCDMa:CDPower:SBOundary:LIST:MS:CHANnel?
[ :SENSE ] :LSEQuencer:WCDMa:CDPower:SBOundary:LIST:MS:NCHANnels?
:CALCulate:LSEQuencer:WCDMa:CDPower:THSDpcch
:CALCulate:LSEQuencer:WCDMa:CDPower:DTXBurst
:CALCulate:LSEQuencer:WCDMa:CDPower:IQPHase:ROTation
:CALCulate:LSEQuencer:WCDMa:CDPower:SSLot:NUMBER
```

W-CDMA Programming Commands
Code Domain Power (CDP)

[:SENSe] :LSEQuencer :WCDMa :CDPower :SPECTrum
:CALCulate :LSEQuencer :WCDMa :CDPower :ASET :THReshold
[:SENSe] :LSEQuencer :WCDMa :CDPower :FILTer [:RRC] [:STATe]
[:SENSe] :LSEQuencer :WCDMa :CDPower :FILTer :ALPHA
[:SENSe] :LSEQuencer :WCDMa :CDPower :CRATe
[:SENSe] :LSEQuencer :WCDMa :CDPower :MCEStimator
[:SENSe] :LSEQuencer :WCDMa :CDPower :MCEStimator :TIMing
[:SENSe] :LSEQuencer :WCDMa :CDPower :FERRor :TRANge
[:SENSe] :LSEQuencer :WCDMa :CDPower :SEVM :FCOMpen
[:SENSe] :LSEQuencer :WCDMa :CDPower :SEVM :PCOMpen
[:SENSe] :LSEQuencer :WCDMa :CDPower :SSUPpress [:STATe]

CDP results

Index	Result Parameter
0	Code Domain Power is 256 I/Q pairs, 512 floating point numbers. The I values are listed first in each pair, using the 0 through even-indexed values. The Q values are the odd-indexed values.
1	Code Domain Error is 256 I/Q Pairs, 512 floating point numbers. The I values are listed first in each pair, using the 0 through even-indexed values. The Q values are the odd-indexed values.

Phase Discontinuity

This section provides the remote control SCPI commands for the W-CDMA Phase Discontinuity measurement from within the List Sequencer. This measurement is available only if you have the W-CDMA measurement application licensed on the test set.

For more detailed information about the Phase Discontinuity measurement, refer to the online help associated with the W-CDMA measurement application, which is also available in PDF format (“User’s and Programmer’s Reference”) on the Keysight website, www.keysight.com/find/e6650a.

You can also refer to the measurement guide for the X-series W-CDMA measurement application, which is available on the Keysight website, www.keysight.com/find/mxa.

Phase Discontinuity measurement SCPI commands

NOTE The W-CDMA Phase Discontinuity measurement is taken from the W-CDMA UE Power Control measurement, and is designated PCONTRol in SCPI for that reason.

There is a set of SCPI commands available to program the W-CDMA Phase Discontinuity measurement when it is used in the W-CDMA mode. To set up the W-CDMA measurements from within the Sequence Analyzer mode you need to prefix the SCPI commands with LSEQuencer:WCDMa. For example, the [:SENSe]:PCONTRol part of the Phase Discontinuity SCPI commands are replaced with [:SENSe]:LSEQuencer:WCDMa:PCONTRol.

The following commands are used to set up the Phase Discontinuity measurement.

```

[:SENSe]:LSEQuencer:WCDMa:PCONTRol:SLOT:FORMat
[:SENSe]:LSEQuencer:WCDMa:PCONTRol:SSLot[:STATe] OFF|ON|0|1
[:SENSe]:LSEQuencer:WCDMa:PCONTRol:SSLot:NUMBer
[:SENSe]:LSEQuencer:WCDMa:PCONTRol:FILTer[:RRC][:STATe]
[:SENSe]:LSEQuencer:WCDMa:PCONTRol:SYNC:SCRamble
[:SENSe]:LSEQuencer:WCDMa:PCONTRol:FILTer[:RRC]:ALPHa
[:SENSe]:LSEQuencer:WCDMa:PCONTRol:CRATe
[:SENSe]:LSEQuencer:WCDMa:PCONTRol:SBOundary:MS
[:SENSe]:LSEQuencer:WCDMa:PCONTRol:SBOundary:LIST:MS:INIT
[:SENSe]:LSEQuencer:WCDMa:PCONTRol:SBOundary:LIST:MS:APPend
[:SENSe]:LSEQuencer:WCDMa:PCONTRol:SBOundary:LIST:MS:REPLace
[:SENSe]:LSEQuencer:WCDMa:PCONTRol:SBOundary:LIST:MS:CHANnel? <entry_id>
[:SENSe]:LSEQuencer:WCDMa:PCONTRol:SBOundary:LIST:MS:NCHANnels?
[:SENSe]:LSEQuencer:WCDMa:PCONTRol:MINTErval
[:SENSe]:LSEQuencer:WCDMa:PCONTRol:SWEep:TIME:TRANsient

```

Phase Discontinuity results

Index	Result Parameter
0	Number of slots: Number of slots found in the captured data.
1	Phase of slot 1
	...
90	Phase of slot 90
91	Phase Discontinuity of slot 1: Fixed to NAN
92	Phase Discontinuity of slot 2: Slot phase discontinuity from the previous slot. (Phase difference between the end of the previous slot and the beginning of the current slot.)
	...
180	Phase Discontinuity of slot 90
181	RMS EVM of slot 1: RMS EVM of slots based on the best-fit line excluding 25 us at the beginning and the end of the slot.
	...
270	RMS EVM of slot 90
271	RMS Magnitude Error of slot 1: RMS Magnitude Error of the slot. It is an element of RMS EVM of the slot.
	...
360	RMS Magnitude Error of slot 90
361	RMS Phase Error of slot 1: RMS phase Error of the slot. It is an element of RMS EVM of the slot.
	...
450	RMS Phase Error of slot 90
451	Frequency Error of slot 1: Frequency Error of the best-fit line for slots excluding 25 us at the beginning and the end of the slot. It also includes the frequency error of the reference frequency that the measurement algorithm determines for synchronization.
	...
540	Frequency Error of slot 90
541	IQ Original Offset of slot 1: IQ Origin offset of the slot. It is an element of RMS EVM of the slot.
	...
630	IQ Original Offset of slot 90
631	Slot Power of slot 1: In-channel power of slot 1

720	Slot Power of slot 1

Loopback BER

This section provides the remote control SCPI commands for the W-CDMA Loopback BER measurement from within the List Sequencer. This measurement is available only if you have the W-CDMA measurement application licensed on the test set.

The W-CDMA Loopback BER measurement is based on the W-CDMA Code Domain Power measurement (CDP) and uses the remote commands associated with that measurement.

For more detailed information about the CDP measurement, refer to the online help associated with the W-CDMA measurement application, which is also available in pdf format on the Keysight website, www.keysight.com/find/e6650a.

Loopback BER measurement SCPI commands

The following commands are used to set up the Loopback BER measurement from within the Sequence Analyzer mode.

```
:CALCulate:LSEQuencer:WCDMa:CDPower:TYPE
:CALCulate:LSEQuencer:WCDMa:CDPower:SRATE
:CALCulate:LSEQuencer:WCDMa:CDPower:SPRead
[:SENSe]:LSEQuencer:WCDMa:CDPower:SYNC:MS
[:SENSe]:LSEQuencer:WCDMa:CDPower:SFORmat:MS
[:SENSe]:LSEQuencer:WCDMa:CDPower:PRACH:SIGNature
[:SENSe]:LSEQuencer:WCDMa:CDPower:SYNC:SCRamble:MS
[:SENSe]:LSEQuencer:WCDMa:CDPower:DPCH:MS:CONFIgure
[:SENSe]:LSEQuencer:WCDMa:CDPower:SBOundary:MS
[:SENSe]:LSEQuencer:WCDMa:CDPower:SBOundary:LIST:MS:INIT
[:SENSe]:LSEQuencer:WCDMa:CDPower:SBOundary:LIST:MS:APPend
[:SENSe]:LSEQuencer:WCDMa:CDPower:SBOundary:LIST:MS:REPLace
[:SENSe]:LSEQuencer:WCDMa:CDPower:SBOundary:LIST:MS:CHANnel?
[:SENSe]:LSEQuencer:WCDMa:CDPower:SBOundary:LIST:MS:NCHANnels?
:CALCulate:LSEQuencer:WCDMa:CDPower:THSDpcch
:CALCulate:LSEQuencer:WCDMa:CDPower:DTXBurst
:CALCulate:LSEQuencer:WCDMa:CDPower:IQPHase:ROtation
:CALCulate:LSEQuencer:WCDMa:CDPower:SSLot:NUMBer
[:SENSe]:LSEQuencer:WCDMa:CDPower:SPECTrum
:CALCulate:LSEQuencer:WCDMa:CDPower:ASET:THReshold
[:SENSe]:LSEQuencer:WCDMa:CDPower:FILTer[:RRC][:STATe]
```

[:SENSE] :LSEQuencer :WCDMa :CDPower :FILTer :ALPHa
[:SENSe] :LSEQuencer :WCDMa :CDPower :CRATe
[:SENSe] :LSEQuencer :WCDMa :CDPower :MCEStimator
[:SENSe] :LSEQuencer :WCDMa :CDPower :MCEStimator :TIMing
[:SENSe] :LSEQuencer :WCDMa :CDPower :FErRor :TRANge
[:SENSe] :LSEQuencer :WCDMa :CDPower :SEVM :FCOMpen
[:SENSe] :LSEQuencer :WCDMa :CDPower :SEVM :PCOMpen
[:SENSe] :LSEQuencer :WCDMa :CDPower :SSUPpress [:STATe]

Loopback BER results

Index	Result Parameter
0	Loopback bit error ratio.
1	Total tested bit number.
2	Failed bit number.
3	Reserve.

15 LTE-FDD Programming Commands

This chapter lists all the commands used to set up the LTE-FDD measurements from within the List Sequencer.

The chapter topics are:

- **Adjacent Channel Power (ACP)**
- **Spectrum Emissions Mask (SEM)**
- **Occupied Bandwidth (OBW)**
- **CEVM**

Adjacent Channel Power (ACP)

This section provides the remote control SCPI commands for the LTE-FDD Adjacent Channel Power (ACP) measurement from within the List Sequencer. This measurement is available only if you have the LTE-FDD measurement application licensed on the test set.

For more detailed information about the ACP measurement, refer to the online help associated with the LTE-FDD measurement application, which is also available in PDF format (“User’s and Programmer’s Reference”) on the Keysight website, www.keysight.com/find/e6650a.

You can also refer to the measurement guide for the X-series LTE-FDD measurement application, which is available on the Keysight website, www.keysight.com/find/mxa.

Adjacent Channel Power (ACP) measurement SCPI commands

There is a set of SCPI commands available to program the LTE-FDD ACP measurement when it is used in the LTE-FDD mode. To set up the LTE-FDD measurements from within the Sequence Analyzer mode you need to prefix the SCPI commands with `LSEQuencer:LTE`. For example, the `[:SENSe]:ACPower` part of the ACP SCPI commands are replaced with `[:SENSe]:LSEQuencer:LTE:ACPower`.

The following commands are used to set up the ACP measurement.

```
[:SENSe]:LSEQuencer:LTE:ACPower:BANDwidth[:RESolution]
[:SENSe]:LSEQuencer:LTE:ACPower:BANDwidth:SHAPE
[:SENSe]:LSEQuencer:LTE:ACPower:BANDwidth:TYPE
[:SENSe]:LSEQuencer:LTE:ACPower:CARRier[1]|2:COUNT
[:SENSe]:LSEQuencer:LTE:ACPower:CARRier[1]|2:REFerence
[:SENSe]:LSEQuencer:LTE:ACPower:CARRier[1]|2:RCARRier:AUTO
[:SENSe]:LSEQuencer:LTE:ACPower:CARRier[1]|2:RCFrequency
[:SENSe]:LSEQuencer:LTE:ACPower:CARRier[1]|2:RCFrequency:AUTO
[:SENSe]:LSEQuencer:LTE:ACPower:CARRier[1]|2[:POWER]
[:SENSe]:LSEQuencer:LTE:ACPower:CARRier[1]|2:AUTO[:STATE]
[:SENSe]:LSEQuencer:LTE:ACPower:CARRier[1]|2:CPSD
[:SENSe]:LSEQuencer:LTE:ACPower:CARRier[1]|2:LIST:COUPle
[:SENSe]:LSEQuencer:LTE:ACPower:CARRier[1]|2:LIST:PPResent
[:SENSe]:LSEQuencer:LTE:ACPower:CARRier[1]|2:LIST:WIDTH
[:SENSe]:LSEQuencer:LTE:ACPower:CARRier[1]|2:LIST:BANDwidth[:INTegration]
[:SENSe]:LSEQuencer:LTE:ACPower:CARRier[1]|2:LIST:METHod
[:SENSe]:LSEQuencer:LTE:ACPower:CARRier[1]|2:LIST:FILTer:ALPHA
[:SENSe]:LSEQuencer:LTE:ACPower:OFFSet[1]|2:LIST[:FREQUENCY]
[:SENSe]:LSEQuencer:LTE:ACPower:OFFSet[1]|2:LIST:STATE
```



```
[ :SENSE ] :LSEQuencer :LTE :ACPpower :OFFSet [1] | 2 :LIST :BANDwidth
[ :SENSe ] :LSEQuencer :LTE :ACPpower :OFFSet [1] | 2 :LIST :BANDwidth :RESolution
[ :SENSe ] :LSEQuencer :LTE :ACPpower :OFFSet [1] | 2 :LIST :BANDwidth :RESolution :AUTO
[ :SENSe ] :LSEQuencer :LTE :ACPpower :OFFSet [1] | 2 :LIST :BANDwidth :SHAPE
[ :SENSe ] :LSEQuencer :LTE :ACPpower :OFFSet [1] | 2 :LIST :BANDwidth :TYPE
[ :SENSe ] :LSEQuencer :LTE :ACPpower :OFFSet [1] | 2 :LIST :ABSolute
[ :SENSe ] :LSEQuencer :LTE :ACPpower :OFFSet [1] | 2 :LIST :TEST
[ :SENSe ] :LSEQuencer :LTE :ACPpower :OFFSet [1] | 2 :LIST :RCARrier
[ :SENSe ] :LSEQuencer :LTE :ACPpower :OFFSet [1] | 2 :LIST :RPSDensity
```

ACP results

Index	Result Parameter
0	Overall Pass/Fail result - returns 24 scalar values of the pass/fail (0.0 = pass, 1.0 = fail) determined by testing the relative to the reference carrier and by testing the absolute power limit of the offset frequencies (measured as total power in dBm)
	1. Lower Offset A - relative limit test result
	2. Lower Offset A - absolute limit test result
	3. Upper Offset A - relative limit test result
	4. Upper Offset A - absolute limit test result
	5. Lower Offset B - relative limit test result
	6. Lower Offset B - absolute limit test result
	7. Upper Offset B - relative limit test result
	8. Upper Offset B - absolute limit test result
	...
	21. Lower Offset F - relative limit test result
	22. Lower Offset F - absolute limit test result
	23. Upper Offset F - relative limit test result
	24. Upper Offset F - absolute limit test result

LTE-FDD Programming Commands
 Adjacent Channel Power (ACP)

1	<p>Carrier Powers - returns three scalar values representing overall pass/fail, carrier power, and reference carrier power</p> <ol style="list-style-type: none"> 1. Overall Pass/Fail 2. Total Carrier Power 3. Reference Carrier Power <p>If meas type is Total Power Reference, these results are returned in units of dBm. If Meas Type is Power Spectral Density Reference, these results are returned in units of dBm/Hz or dBm/MHz.</p>
2	<p>Power Results</p> <ol style="list-style-type: none"> 1. Channel (1) - relative power 2. Channel (1) - absolute power 3. Channel (1) - relative power 4. Channel (1) - absolute power ... 23. Channel (1) - relative power 24. Channel (1) - absolute power 25. Lower Offset A - relative power 26. Lower Offset A - absolute power 27. Upper Offset A - relative power 28. Upper Offset A - absolute power 29. Lower Offset B - relative power 30. Lower Offset B - absolute power 31. Upper Offset B - relative power 32. Upper Offset B - absolute power ... 45. Lower Offset F - relative power 46. Lower Offset F - absolute power 47. Upper Offset F - relative power 48. Upper Offset F - absolute power <p>If Meas Type is Total Power Reference, these results are returned in units of dBm. If Meas Type is Power Spectral Density Reference, these results are returned in units of dBm/Hz or dBm/MHz.</p>

Spectrum Emissions Mask (SEM)

This section provides the remote control SCPI commands for the LTE-FDD Spectrum Emissions Mask (SEM) measurement from within the List Sequencer. This measurement is available only if you have the LTE-FDD measurement application licensed on the test set.

For more detailed information about the SEM measurement, refer to the online help associated with the LTE-FDD measurement application, which is also available in PDF format (“User’s and Programmer’s Reference”) on the Keysight website, www.keysight.com/find/e6650a.

You can also refer to the measurement guide for the X-series LTE-FDD measurement application, which is available on the Keysight website, www.keysight.com/find/mxa.

SEM measurement SCPI commands

There is a set of SCPI commands available to program the LTE-FDD SEM measurement when it is used in the LTE-FDD mode. To set up the LTE-FDD measurements from within the Sequence Analyzer mode you need to prefix the SCPI commands with `LSEQuencer:LTE`. For example, the `[:SENSe]:SEMAsk` part of the SEM SCPI commands are replaced with:

```
[:SENSe]:LSEQuencer:LTE:SEMAsk
```

The following commands are used to set up the SEM measurement.

```
[:SENSe]:LSEQuencer:LTE:SEMAsk:TYPE
```

```
[:SENSe]:LSEQuencer:LTE:SEMAsk:BANDwidth[1]|2:INTegration
```

```
[:SENSe]:LSEQuencer:LTE:SEMAsk:FREQuency[1]|2:SPAN
```

```
[:SENSe]:LSEQuencer:LTE:SEMAsk:BANDwidth[1]|2[:RESolution]
```

```
[:SENSe]:LSEQuencer:LTE:SEMAsk:BANDwidth[1]|2[:RESolution]:AUTO
```

```
[:SENSe]:LSEQuencer:LTE:SEMAsk:CARRier[:POWER]
```

```
[:SENSe]:LSEQuencer:LTE:SEMAsk:CARRier:AUTO[:STATE]
```

```
[:SENSe]:LSEQuencer:LTE:SEMAsk:CARRier:CPSD
```

```
[:SENSe]:LSEQuencer:LTE:SEMAsk:CARRier:PEAK[:POWER]
```

```
[:SENSe]:LSEQuencer:LTE:SEMAsk:OFFSet[1]|2:LIST:FREQuency:START
```

```
[:SENSe]:LSEQuencer:LTE:SEMAsk:OFFSet[1]|2:LIST:STATE
```

```
[:SENSe]:LSEQuencer:LTE:SEMAsk:OFFSet[1]|2:LIST:FREQuency:STOP
```

```
[:SENSe]:LSEQuencer:LTE:SEMAsk:OFFSet[1]|2:LIST:SIDE
```

```
[:SENSe]:LSEQuencer:LTE:SEMAsk:OFFSet[1]|2:LIST:BANDwidth[:RESolution]
```

```
[:SENSe]:LSEQuencer:LTE:SEMAsk:OFFSet[1]|2:LIST:BANDwidth[:RESolution]:AUTO
```

```
[:SENSe]:LSEQuencer:LTE:SEMAsk:OFFSet[1]|2:LIST:BANDwidth:IMULTi
```

```
[:SENSe]:LSEQuencer:LTE:SEMAsk:OFFSet[1]|2:LIST:START:ABSolute
```

```
[:SENSe]:LSEQuencer:LTE:SEMAsk:OFFSet[1]|2:LIST:STOP:ABSolute
```

```
[:SENSe]:LSEQuencer:LTE:SEMAsk:OFFSet[1]|2:LIST:STOP:ABSoluteCOUPLE
```

LTE-FDD Programming Commands
Spectrum Emissions Mask (SEM)

```
[ :SENSe ] :LSEQuencer :LTE :SEMAsk :OFFSet [ 1 ] | 2 :LIST :START :RCARrier  
[ :SENSe ] :LSEQuencer :LTE :SEMAsk :OFFSet [ 1 ] | 2 :LIST :STOP :RCARrier  
[ :SENSe ] :LSEQuencer :LTE :SEMAsk :OFFSet [ 1 ] | 2 :LIST :STOP :RCARrier :COUPle  
[ :SENSe ] :LSEQuencer :LTE :SEMAsk :OFFSet [ 1 ] | 2 :LIST :TEST  
[ :SENSe ] :LSEQuencer :LTE :SEMAsk :FILTer [ :RRC ] [ :STATe ]  
[ :SENSe ] :LSEQuencer :LTE :SEMAsk :FILTer [ :RRC ] :ALPHa  
[ :SENSe ] :LSEQuencer :LTE :SEMAsk :LIMits  
[ :SENSe ] :LSEQuencer :LTE :SEMAsk :TYPE  
:TRACe :LSEQuencer :LTE :SEMAsk :TYPE
```

SEM results

Index	Result Parameter
0	Overall Pass/Fail result shows the mask test result (0 = pass, 1 = fail, -1 not tested)
1	<p>Main Results</p> <ol style="list-style-type: none"> 1. Absolute power at center frequency (reference) area (dBm) 2. Peak Frequency in the center frequency (reference) area (Hz) 3. Relative integrated power on the negative offset A (dBc) 4. Absolute integrated power on the negative offset A (dBm or dBm/Hz) 5. Relative peak power on the negative offset A (dBc) 6. Absolute peak power on the negative offset A (dBm or dBm/Hz) 7. Peak power offset frequency from the center frequency in the negative offset A (Hz) 8. Relative integrated power on the positive offset A (dBc) 9. Absolute integrated power on the positive offset A (dBm or dBm/Hz) 10. Relative peak power on the positive offset A (dBc) 11. Absolute peak power on the positive offset A (dBm or dBm/Hz) 12. Peak power offset frequency from the center frequency in the positive offset A (Hz) 13. Relative integrated power on the negative offset B (dBc) <p>...</p> <ol style="list-style-type: none"> 61. Absolute peak power on the positive offset F (dBm or dBm/Hz) 62. Peak power offset frequency from the center frequency in the positive offset F (Hz) 63. Minimum margin from limit line on the negative offset A (dB) 64. Minimum margin from limit line on the positive offset A (dB) 65. Minimum margin from limit line on the negative offset B (dB) 66. Minimum margin from limit line on the positive offset B (dB) 67. Minimum margin from limit line on the negative offset C (dB) 68. Minimum margin from limit line on the positive offset C (dB) 69. Minimum margin from limit line on the negative offset D (dB) 70. Minimum margin from limit line on the positive offset D (dB) 71. Minimum margin from limit line on the negative offset E (dB) 72. Minimum margin from limit line on the positive offset E (dB) 73. Minimum margin from limit line on the negative offset F (dB) 74. Minimum margin from limit line on the positive offset F (dB) <p>The unit for the absolute power results varies depending on the measurement type:</p> <p>If the measurement type is Total Power Reference, these results are expressed in dBm.</p> <p>If the measurement type is Power Spectral Density Reference, these results are expressed in dBm/Hz.</p>

Occupied Bandwidth (OBW)

This section provides the remote control SCPI commands for the LTE-FDD Occupied Bandwidth (OBW) measurement from within the List Sequencer. This measurement is available only if you have the LTE-FDD measurement application licensed on the test set.

For more detailed information about the OBW measurement, refer to the online help associated with the LTE-FDD measurement application, which is also available in PDF format (“User’s and Programmer’s Reference”) on the Keysight website, www.keysight.com/find/e6650a.

You can also refer to the measurement guide for the X-series LTE-FDD measurement application, which is available on the Keysight website, www.keysight.com/find/mxa.

OBW measurement SCPI commands

There is a set of SCPI commands available to program the LTE-FDD OBW measurement when it is used in the LTE-FDD mode. To set up the LTE-FDD measurements from within the Sequence Analyzer mode you need to prefix the SCPI commands with LSEQuencer:LTE. For example, the [:SENSe]:OBWidth part of the OBW SCPI commands are replaced with [:SENSe]:LSEQuencer:LTE:OBWidth.

The following commands are used to set up the OBW measurement.

```
[:SENSe]:LSEQuencer:LTETdd:OBWidth:BANDwidth[:RESolution]
```

```
[:SENSe]:LSEQuencer:LTETdd:OBWidth:BANDwidth:SHAPE
```

```
[:SENSe]:LSEQuencer:LTETdd:OBWidth:PERCent
```

```
[:SENSe]:LSEQuencer:LTETdd:OBWidth:XDB
```

```
CALCulate: [SENSe]:LSEQuencer:LTETdd:OBWidth:LIMit:FBLimit
```

```
CALCulate: [SENSe]:LSEQuencer:LTETdd:OBWidth:LIMit[:TEST]
```

```
[:SENSe]:LSEQuencer:LTETdd:OBWidth:FREQuency:SPAN
```

```
[:SENSe]:LSEQuencer:LTETdd:OBWidth:FREQuency:SPAN:FULL
```

```
[:SENSe]:LSEQuencer:LTETdd:OBWidth:FREQuency:SPAN:PREVIOUS
```

OBW results

Index	Result Parameter
0	Overall Pass/Fail
1	Main Results 1. Occupied Bandwidth (Hz) 2. Transmit Frequency Error (Hz) 3. x dB bandwidth (Hz)

CEVM

This section provides the remote control SCPI commands for the LTE-FDD CEVM measurement from within the List Sequencer. This measurement is available only if you have the LTE-FDD measurement application licensed on the test set.

For more detailed information about the CEVM measurement, refer to the online help associated with the LTE-FDD measurement application, which is also available in PDF format (“User’s and Programmer’s Reference”) on the Keysight website, www.keysight.com/find/e6650a.

You can also refer to the measurement guide for the X-series LTE-FDD measurement application, which is available on Keysight website, www.keysight.com/find/mxa.

CEVM measurement SCPI commands

There is a set of SCPI commands available to program the LTE-FDD CEVM measurement when it is used in the LTE-FDD mode. To set up the LTE-FDD measurements from within the Sequence Analyzer mode you need to prefix the SCPI commands with `LSEQuencer:LTE`. For example, the `[:SENSe]:CEVM` part of the modulation accuracy SCPI commands are replaced with:

```
[:SENSe]:LSEQuencer:LTE:CEVM
```

The following commands are used to set up the modulation accuracy measurement.

```
[:SENSe]:CEVM:EETTime
[:SENSe]:CEVM:EQUalizer:TRaining
[:SENSe]:CEVM:EQUalizer:TRaining:MAFilter
[:SENSe]:CEVM:EQUalizer:TRaining:MAFilter:LENGth
[:SENSe]:CEVM:EQUalizer:TRaining:MCFNormalize
[:SENSe]:CEVM:EQUalizer:TRaining:MODE
[:SENSe]:CEVM:EVMMinimize
[:SENSe]:CEVM:EVMMinimize:AMPLitude
[:SENSe]:CEVM:EVMMinimize:FREQuency
[:SENSe]:CEVM:EVMMinimize:IQOffset
[:SENSe]:CEVM:EVMMinimize:TIMing
[:SENSe]:CEVM:EXTended:FREQuency:LOCK:RANGE
[:SENSe]:CEVM:MCFilter:STATE
[:SENSe]:CEVM:POWer:BOOST:NORMALize
[:SENSe]:CEVM:PROFile:AUTO[:DETECT]
[:SENSe]:CEVM:PROFile:NALLocation
[:SENSe]:CEVM:SYMBOL:TIMing:ADJust
[:SENSe]:CEVM:SYMBOL:TIMing:ADJust:USER
[:SENSe]:CEVM:TIME:ASBoundary
[:SENSe]:CEVM:TIME:INTerval:SLOT
[:SENSe]:CEVM:TIME:INTerval:SYMBOL
[:SENSe]:CEVM:TIME:OFFSet:SLOT
[:SENSe]:CEVM:TIME:OFFSet:SYMBOL
[:SENSe]:CEVM:TIME:RESult:LENGth
[:SENSe]:CEVM:ULINK:DECode:PUSCh
[:SENSe]:CEVM:ULINK:PROFile:ADD:USER/nquery/
[:SENSe]:CEVM:ULINK:PROFile:AUTO:CID
[:SENSe]:CEVM:ULINK:PROFile:AUTO[:DETECT]:POWer
```

LTE-FDD Programming Commands
CEVM

[:SENSE] :CEVM:ULINK:PROFile:AUTO:HOPPing:GROup
[:SENSE] :CEVM:ULINK:PROFile:AUTO:HOPPing:SEQuence
[:SENSE] :CEVM:ULINK:PROFile:AUTO:PRACH
[:SENSE] :CEVM:ULINK:PROFile:AUTO:PRACH:ACTive
[:SENSE] :CEVM:ULINK:PROFile:AUTO:PRACH:CINdex
[:SENSE] :CEVM:ULINK:PROFile:AUTO:PRACH:CSSet
[:SENSE] :CEVM:ULINK:PROFile:AUTO:PRACH:LRSindex
[:SENSE] :CEVM:ULINK:PROFile:AUTO:PRACH:NCSConfig
[:SENSE] :CEVM:ULINK:PROFile:AUTO:PRACH:PINdex
[:SENSE] :CEVM:ULINK:PROFile:AUTO:PRACH:PWRBoost
[:SENSE] :CEVM:ULINK:PROFile:AUTO:PUCCh
[:SENSE] :CEVM:ULINK:PROFile:AUTO:PUCCh:ACTive
[:SENSE] :CEVM:ULINK:PROFile:AUTO:PUCCh:CSHift
[:SENSE] :CEVM:ULINK:PROFile:AUTO:PUCCh:DMRS
[:SENSE] :CEVM:ULINK:PROFile:AUTO:PUCCh:DMRS:GROup
[:SENSE] :CEVM:ULINK:PROFile:AUTO:PUCCh:DMRS:PARams
[:SENSE] :CEVM:ULINK:PROFile:AUTO:PUCCh:DMRS:PWRBoost
[:SENSE] :CEVM:ULINK:PROFile:AUTO:PUCCh:FNPucch:AUTO
[:SENSE] :CEVM:ULINK:PROFile:AUTO:PUCCh:FORMat
[:SENSE] :CEVM:ULINK:PROFile:AUTO:PUCCh:N:ONE
[:SENSE] :CEVM:ULINK:PROFile:AUTO:PUCCh:N:TWO
[:SENSE] :CEVM:ULINK:PROFile:AUTO:PUCCh:NCS:ONE
[:SENSE] :CEVM:ULINK:PROFile:AUTO:PUCCh:NRB:TWO
[:SENSE] :CEVM:ULINK:PROFile:AUTO:PUCCh:OS
[:SENSE] :CEVM:ULINK:PROFile:AUTO:PUCCh:PWRBoost
[:SENSE] :CEVM:ULINK:PROFile:AUTO:PUCCh:RB
[:SENSE] :CEVM:ULINK:PROFile:AUTO:PUCCh:SHIFt
[:SENSE] :CEVM:ULINK:PROFile:AUTO:PUCCh:SSLot
[:SENSE] :CEVM:ULINK:PROFile:AUTO:PUCCh:SSLot:AUTO
[:SENSE] :CEVM:ULINK:PROFile:AUTO:PUSCh
[:SENSE] :CEVM:ULINK:PROFile:AUTO:PUSCh:ACTive
[:SENSE] :CEVM:ULINK:PROFile:AUTO:PUSCh:DMRS
[:SENSE] :CEVM:ULINK:PROFile:AUTO:PUSCh:DMRS:CSHift
[:SENSE] :CEVM:ULINK:PROFile:AUTO:PUSCh:DMRS:GROup
[:SENSE] :CEVM:ULINK:PROFile:AUTO:PUSCh:DMRS:ONE
[:SENSE] :CEVM:ULINK:PROFile:AUTO:PUSCh:DMRS:PARams
[:SENSE] :CEVM:ULINK:PROFile:AUTO:PUSCh:DMRS:PWRBoost
[:SENSE] :CEVM:ULINK:PROFile:AUTO:PUSCh:DMRS:SEQuence
[:SENSE] :CEVM:ULINK:PROFile:AUTO:PUSCh:DMRS:TWO
[:SENSE] :CEVM:ULINK:PROFile:AUTO:PUSCh:DSS
[:SENSE] :CEVM:ULINK:PROFile:AUTO:PUSCh:NSB
[:SENSE] :CEVM:ULINK:PROFile:AUTO:PUSCh:PWRBoost
[:SENSE] :CEVM:ULINK:PROFile:AUTO:PUSCh:RB:END
[:SENSE] :CEVM:ULINK:PROFile:AUTO:PUSCh:RB:START
[:SENSE] :CEVM:ULINK:PROFile:AUTO:PUSCh:SSLot
[:SENSE] :CEVM:ULINK:PROFile:AUTO:PUSCh:SSLot:AUTO
[:SENSE] :CEVM:ULINK:PROFile:AUTO:RNTI
[:SENSE] :CEVM:ULINK:PROFile:AUTO:SFNumber
[:SENSE] :CEVM:ULINK:PROFile:AUTO:SRS

```

[:SENSE]:CEVM:ULINK:PROFile:AUTO:SRS:ACTive
[:SENSE]:CEVM:ULINK:PROFile:AUTO:SRS:BCONfig
[:SENSE]:CEVM:ULINK:PROFile:AUTO:SRS:BWIDth
[:SENSE]:CEVM:ULINK:PROFile:AUTO:SRS:CINdex
[:SENSE]:CEVM:ULINK:PROFile:AUTO:SRS:CSHift
[:SENSE]:CEVM:ULINK:PROFile:AUTO:SRS:FDPosition
[:SENSE]:CEVM:ULINK:PROFile:AUTO:SRS:HBWidth
[:SENSE]:CEVM:ULINK:PROFile:AUTO:SRS:PWRBoost
[:SENSE]:CEVM:ULINK:PROFile:AUTO:SRS:SFConfig
[:SENSE]:CEVM:ULINK:PROFile:AUTO:SRS:SSLot
[:SENSE]:CEVM:ULINK:PROFile:AUTO:SRS:SSLot:AUTO
[:SENSE]:CEVM:ULINK:PROFile:AUTO:SRS:TCOMb
[:SENSE]:CEVM:ULINK:PROFile:CLear/nquery/
[:SENSE]:CEVM:ULINK:PROFile:COUNT?/qonly/
[:SENSE]:CEVM:ULINK:PROFile:EXCLude:ALL/nquery/
[:SENSE]:CEVM:ULINK:PROFile:INCLude:ALL/nquery/
[:SENSE]:CEVM:ULINK:PROFile:USER{1:50}:CID
[:SENSE]:CEVM:ULINK:PROFile:USER{1:50}:DELete/nquery/
[:SENSE]:CEVM:ULINK:PROFile:USER{1:50}:HOPPing:GROup
[:SENSE]:CEVM:ULINK:PROFile:USER{1:50}:HOPPing:SEQuence
[:SENSE]:CEVM:ULINK:PROFile:USER{1:50}:PRACH
[:SENSE]:CEVM:ULINK:PROFile:USER{1:50}:PRACH:ACTive
[:SENSE]:CEVM:ULINK:PROFile:USER{1:50}:PRACH:CINdex
[:SENSE]:CEVM:ULINK:PROFile:USER{1:50}:PRACH:CSSet
[:SENSE]:CEVM:ULINK:PROFile:USER{1:50}:PRACH:LRSindex
[:SENSE]:CEVM:ULINK:PROFile:USER{1:50}:PRACH:NCSConfig
[:SENSE]:CEVM:ULINK:PROFile:USER{1:50}:PRACH:NRAPrb
[:SENSE]:CEVM:ULINK:PROFile:USER{1:50}:PRACH:PINdex
[:SENSE]:CEVM:ULINK:PROFile:USER{1:50}:PRACH:PWRBoost
[:SENSE]:CEVM:ULINK:PROFile:USER{1:50}:PUCCh
[:SENSE]:CEVM:ULINK:PROFile:USER{1:50}:PUCCh:ACTive
[:SENSE]:CEVM:ULINK:PROFile:USER{1:50}:PUCCh:ADD:SLOT/nquery/
[:SENSE]:CEVM:ULINK:PROFile:USER{1:50}:PUCCh:COUNT?/qonly/
[:SENSE]:CEVM:ULINK:PROFile:USER{1:50}:PUCCh:CSHift
[:SENSE]:CEVM:ULINK:PROFile:USER{1:50}:PUCCh:CSHift:COUple
[:SENSE]:CEVM:ULINK:PROFile:USER{1:50}:PUCCh:DMRS
[:SENSE]:CEVM:ULINK:PROFile:USER{1:50}:PUCCh:DMRS:GROup
[:SENSE]:CEVM:ULINK:PROFile:USER{1:50}:PUCCh:DMRS:GROup:COUple
[:SENSE]:CEVM:ULINK:PROFile:USER{1:50}:PUCCh:DMRS:PARams
[:SENSE]:CEVM:ULINK:PROFile:USER{1:50}:PUCCh:DMRS:PWRBoost
[:SENSE]:CEVM:ULINK:PROFile:USER{1:50}:PUCCh:DMRS:PWRBoost:COUple
[:SENSE]:CEVM:ULINK:PROFile:USER{1:50}:PUCCh:FORMat
[:SENSE]:CEVM:ULINK:PROFile:USER{1:50}:PUCCh:FORMat:COUple
[:SENSE]:CEVM:ULINK:PROFile:USER{1:50}:PUCCh:N:ONE
[:SENSE]:CEVM:ULINK:PROFile:USER{1:50}:PUCCh:N:ONE:COUple
[:SENSE]:CEVM:ULINK:PROFile:USER{1:50}:PUCCh:N:TWO
[:SENSE]:CEVM:ULINK:PROFile:USER{1:50}:PUCCh:NCS:ONE
[:SENSE]:CEVM:ULINK:PROFile:USER{1:50}:PUCCh:NRB:TWO
[:SENSE]:CEVM:ULINK:PROFile:USER{1:50}:PUCCh:OS

```

LTE-FDD Programming Commands
CEVM

[:SENSE] : CEVM : ULINK : PROFILE : USER { 1 : 50 } : PUCCh : OS : COUPle
[:SENSE] : CEVM : ULINK : PROFILE : USER { 1 : 50 } : PUCCh : PWRBoost
[:SENSE] : CEVM : ULINK : PROFILE : USER { 1 : 50 } : PUCCh : PWRBoost : COUPle
[:SENSE] : CEVM : ULINK : PROFILE : USER { 1 : 50 } : PUCCh : RB
[:SENSE] : CEVM : ULINK : PROFILE : USER { 1 : 50 } : PUCCh : RB : COUPle
[:SENSE] : CEVM : ULINK : PROFILE : USER { 1 : 50 } : PUCCh : SHIFt
[:SENSE] : CEVM : ULINK : PROFILE : USER { 1 : 50 } : PUCCh : SLOT { 0 : 19 } : CSHift
[:SENSE] : CEVM : ULINK : PROFILE : USER { 1 : 50 } : PUCCh : SLOT { 0 : 19 } : DELete/nquery/
[:SENSE] : CEVM : ULINK : PROFILE : USER { 1 : 50 } : PUCCh : SLOT { 0 : 19 } : DMRS : GROUp
[:SENSE] : CEVM : ULINK : PROFILE : USER { 1 : 50 } : PUCCh : SLOT { 0 : 19 } : DMRS : PWRBoost
[:SENSE] : CEVM : ULINK : PROFILE : USER { 1 : 50 } : PUCCh : SLOT { 0 : 19 } : FORMat
[:SENSE] : CEVM : ULINK : PROFILE : USER { 1 : 50 } : PUCCh : SLOT { 0 : 19 } : N : ONE
[:SENSE] : CEVM : ULINK : PROFILE : USER { 1 : 50 } : PUCCh : SLOT { 0 : 19 } : OS
[:SENSE] : CEVM : ULINK : PROFILE : USER { 1 : 50 } : PUCCh : SLOT { 0 : 19 } : POSItion?/qonly/
[:SENSE] : CEVM : ULINK : PROFILE : USER { 1 : 50 } : PUCCh : SLOT { 0 : 19 } : PWRBoost
[:SENSE] : CEVM : ULINK : PROFILE : USER { 1 : 50 } : PUCCh : SLOT { 0 : 19 } : RB
[:SENSE] : CEVM : ULINK : PROFILE : USER { 1 : 50 } : PUCCh : SSLot
[:SENSE] : CEVM : ULINK : PROFILE : USER { 1 : 50 } : PUCCh : SSLot : AUTO
[:SENSE] : CEVM : ULINK : PROFILE : USER { 1 : 50 } : PUSCh
[:SENSE] : CEVM : ULINK : PROFILE : USER { 1 : 50 } : PUSCh : ACTive
[:SENSE] : CEVM : ULINK : PROFILE : USER { 1 : 50 } : PUSCh : ADD : SLOT/nquery/
[:SENSE] : CEVM : ULINK : PROFILE : USER { 1 : 50 } : PUSCh : COUNT?/qonly/
[:SENSE] : CEVM : ULINK : PROFILE : USER { 1 : 50 } : PUSCh : CTNB
[:SENSE] : CEVM : ULINK : PROFILE : USER { 1 : 50 } : PUSCh : CTNB : COUPle
[:SENSE] : CEVM : ULINK : PROFILE : USER { 1 : 50 } : PUSCh : DMRS
[:SENSE] : CEVM : ULINK : PROFILE : USER { 1 : 50 } : PUSCh : DMRS : CSHift
[:SENSE] : CEVM : ULINK : PROFILE : USER { 1 : 50 } : PUSCh : DMRS : CSHift : COUPle
[:SENSE] : CEVM : ULINK : PROFILE : USER { 1 : 50 } : PUSCh : DMRS : GROUp
[:SENSE] : CEVM : ULINK : PROFILE : USER { 1 : 50 } : PUSCh : DMRS : GROUp : COUPle
[:SENSE] : CEVM : ULINK : PROFILE : USER { 1 : 50 } : PUSCh : DMRS : ONE
[:SENSE] : CEVM : ULINK : PROFILE : USER { 1 : 50 } : PUSCh : DMRS : PARAmS
[:SENSE] : CEVM : ULINK : PROFILE : USER { 1 : 50 } : PUSCh : DMRS : PWRBoost
[:SENSE] : CEVM : ULINK : PROFILE : USER { 1 : 50 } : PUSCh : DMRS : PWRBoost : COUPle
[:SENSE] : CEVM : ULINK : PROFILE : USER { 1 : 50 } : PUSCh : DMRS : SEQuence
[:SENSE] : CEVM : ULINK : PROFILE : USER { 1 : 50 } : PUSCh : DMRS : SEQuence : COUPle
[:SENSE] : CEVM : ULINK : PROFILE : USER { 1 : 50 } : PUSCh : DMRS : TWO
[:SENSE] : CEVM : ULINK : PROFILE : USER { 1 : 50 } : PUSCh : DSS
[:SENSE] : CEVM : ULINK : PROFILE : USER { 1 : 50 } : PUSCh : FHOPping
[:SENSE] : CEVM : ULINK : PROFILE : USER { 1 : 50 } : PUSCh : MODulation : TYPE
[:SENSE] : CEVM : ULINK : PROFILE : USER { 1 : 50 } : PUSCh : MODulation : TYPE : COUPle
[:SENSE] : CEVM : ULINK : PROFILE : USER { 1 : 50 } : PUSCh : NRBHo
[:SENSE] : CEVM : ULINK : PROFILE : USER { 1 : 50 } : PUSCh : NSB
[:SENSE] : CEVM : ULINK : PROFILE : USER { 1 : 50 } : PUSCh : PWRBoost
[:SENSE] : CEVM : ULINK : PROFILE : USER { 1 : 50 } : PUSCh : PWRBoost : COUPle
[:SENSE] : CEVM : ULINK : PROFILE : USER { 1 : 50 } : PUSCh : RB : END
[:SENSE] : CEVM : ULINK : PROFILE : USER { 1 : 50 } : PUSCh : RB : END : COUPle
[:SENSE] : CEVM : ULINK : PROFILE : USER { 1 : 50 } : PUSCh : RB : START
[:SENSE] : CEVM : ULINK : PROFILE : USER { 1 : 50 } : PUSCh : RB : START : COUPle
[:SENSE] : CEVM : ULINK : PROFILE : USER { 1 : 50 } : PUSCh : SLOT { 0 : 19 } : CTNB

```

[:SENSE]:CEVM:ULINK:PROFile:USER{1:50}:PUSCh:SLOT{0:19}:DELeTe/nquery/
[:SENSE]:CEVM:ULINK:PROFile:USER{1:50}:PUSCh:SLOT{0:19}:DMRS:CSHift
[:SENSE]:CEVM:ULINK:PROFile:USER{1:50}:PUSCh:SLOT{0:19}:DMRS:GRoup
[:SENSE]:CEVM:ULINK:PROFile:USER{1:50}:PUSCh:SLOT{0:19}:DMRS:PWRBoost
[:SENSE]:CEVM:ULINK:PROFile:USER{1:50}:PUSCh:SLOT{0:19}:DMRS:SEQuence
[:SENSE]:CEVM:ULINK:PROFile:USER{1:50}:PUSCh:SLOT{0:19}:MODulation:TYPE
[:SENSE]:CEVM:ULINK:PROFile:USER{1:50}:PUSCh:SLOT{0:19}:POSition?/qonly/
[:SENSE]:CEVM:ULINK:PROFile:USER{1:50}:PUSCh:SLOT{0:19}:PWRBoost
[:SENSE]:CEVM:ULINK:PROFile:USER{1:50}:PUSCh:SLOT{0:19}:RB:END
[:SENSE]:CEVM:ULINK:PROFile:USER{1:50}:PUSCh:SLOT{0:19}:RB:START
[:SENSE]:CEVM:ULINK:PROFile:USER{1:50}:PUSCh:SSLot
[:SENSE]:CEVM:ULINK:PROFile:USER{1:50}:PUSCh:SSLot:AUTO
[:SENSE]:CEVM:ULINK:PROFile:USER{1:50}:RNTI
[:SENSE]:CEVM:ULINK:PROFile:USER{1:50}:SFNumber
[:SENSE]:CEVM:ULINK:PROFile:USER{1:50}:SRS
[:SENSE]:CEVM:ULINK:PROFile:USER{1:50}:SRS:ACTive
[:SENSE]:CEVM:ULINK:PROFile:USER{1:50}:SRS:BCONfig
[:SENSE]:CEVM:ULINK:PROFile:USER{1:50}:SRS:BWIDth
[:SENSE]:CEVM:ULINK:PROFile:USER{1:50}:SRS:CINdex
[:SENSE]:CEVM:ULINK:PROFile:USER{1:50}:SRS:CSHift
[:SENSE]:CEVM:ULINK:PROFile:USER{1:50}:SRS:FDPosition
[:SENSE]:CEVM:ULINK:PROFile:USER{1:50}:SRS:HBWidth
[:SENSE]:CEVM:ULINK:PROFile:USER{1:50}:SRS:PWRBoost
[:SENSE]:CEVM:ULINK:PROFile:USER{1:50}:SRS:SFConfig
[:SENSE]:CEVM:ULINK:PROFile:USER{1:50}:SRS:SSLot
[:SENSE]:CEVM:ULINK:PROFile:USER{1:50}:SRS:SSLot:AUTO
[:SENSE]:CEVM:ULINK:PROFile:USER{1:50}:SRS:TCOMb
[:SENSE]:CEVM:ULINK:SYNC:CPLength
[:SENSE]:CEVM:ULINK:SYNC:HSSHift
[:SENSE]:CEVM:ULINK:SYNC:PDSwap
[:SENSE]:CEVM:ULINK:SYNC:TYPE
[:SENSE]:WINDow:LENGth
[:SENSE]:WINDow:LENGth:CUSTom
[:SENSE]:CEVM:DLINK:DECode
[:SENSE]:CEVM:DLINK:DECode:DFINclude
[:SENSE]:CEVM:DLINK:DECode:RNTI:MAXimum:RA
[:SENSE]:CEVM:DLINK:DECode:RNTI:MAXimum:TPC
[:SENSE]:CEVM:DLINK:DECode:RNTI:MINimum:RA
[:SENSE]:CEVM:DLINK:DECode:RNTI:MINimum:TPC
[:SENSE]:CEVM:DLINK:PDSCh:CSRatio
[:SENSE]:CEVM:DLINK:PROFile:ADD:USER
[:SENSE]:CEVM:DLINK:PROFile:AUTO[:DETect]:CCPower
[:SENSE]:CEVM:DLINK:PROFile:AUTO[:DETect]:MODE
[:SENSE]:CEVM:DLINK:PROFile:AUTO[:DETect]:POWER
[:SENSE]:CEVM:DLINK:PROFile:AUTO[:DETect]:POWER:PMODE
[:SENSE]:CEVM:DLINK:PROFile:AUTO[:DETect]:POWER:ROUND
[:SENSE]:CEVM:DLINK:PROFile:AUTO:PDSCh:CBIndex
[:SENSE]:CEVM:DLINK:PROFile:AUTO:PDSCh:CDD
[:SENSE]:CEVM:DLINK:PROFile:AUTO:PDSCh:NCODewords

```

LTE-FDD Programming Commands
CEVM

```
[ :SENSE ] :CEVM:DLINK:PROFile:AUTO:PDSCh:NLAYers
[ :SENSE ] :CEVM:DLINK:PROFile:AUTO:PDSCh:PRECoding
[ :SENSE ] :CEVM:DLINK:PROFile:AUTO:PDSCh:QAM16:CWONe:ENABLE
[ :SENSE ] :CEVM:DLINK:PROFile:AUTO:PDSCh:QAM16:CWONe:PWRBoost
[ :SENSE ] :CEVM:DLINK:PROFile:AUTO:PDSCh:QAM16:CWZero:ENABLE
[ :SENSE ] :CEVM:DLINK:PROFile:AUTO:PDSCh:QAM16:EPRE
[ :SENSE ] :CEVM:DLINK:PROFile:AUTO:PDSCh:QAM16:PWRBoost
[ :SENSE ] :CEVM:DLINK:PROFile:AUTO:PDSCh:QAM64:CWONe:ENABLE
[ :SENSE ] :CEVM:DLINK:PROFile:AUTO:PDSCh:QAM64:CWONe:PWRBoost
[ :SENSE ] :CEVM:DLINK:PROFile:AUTO:PDSCh:QAM64:CWZero:ENABLE
[ :SENSE ] :CEVM:DLINK:PROFile:AUTO:PDSCh:QAM64:EPRE
[ :SENSE ] :CEVM:DLINK:PROFile:AUTO:PDSCh:QAM64:PWRBoost
[ :SENSE ] :CEVM:DLINK:PROFile:AUTO:PDSCh:QPSK:CWONe:ENABLE
[ :SENSE ] :CEVM:DLINK:PROFile:AUTO:PDSCh:QPSK:CWONe:PWRBoost
[ :SENSE ] :CEVM:DLINK:PROFile:AUTO:PDSCh:QPSK:CWZero:ENABLE
[ :SENSE ] :CEVM:DLINK:PROFile:AUTO:PDSCh:QPSK:EPRE
[ :SENSE ] :CEVM:DLINK:PROFile:AUTO:PDSCh:QPSK:PWRBoost
[ :SENSE ] :CEVM:DLINK:PROFile:AUTO:PMCH:PWRBoost
[ :SENSE ] :CEVM:DLINK:PROFile:CLear
[ :SENSE ] :CEVM:DLINK:PROFile:COUNT?
[ :SENSE ] :CEVM:DLINK:PROFile:EPRE:PANTenna
[ :SENSE ] :CEVM:DLINK:PROFile:EUSers:COUNT
[ :SENSE ] :CEVM:DLINK:PROFile:EXCLude:ALL
[ :SENSE ] :CEVM:DLINK:PROFile:INCLude:ALL
[ :SENSE ] :CEVM:DLINK:PROFile:MBSFn
[ :SENSE ] :CEVM:DLINK:PROFile:MBSFn:ACTive
[ :SENSE ] :CEVM:DLINK:PROFile:MBSFn:AID
[ :SENSE ] :CEVM:DLINK:PROFile:MBSFn:NMRLength
[ :SENSE ] :CEVM:DLINK:PROFile:MBSFn:PWRBoost
[ :SENSE ] :CEVM:DLINK:PROFile:MBSFn:SUBFrame{1:9}:ACTive
[ :SENSE ] :CEVM:DLINK:PROFile:PBCH
[ :SENSE ] :CEVM:DLINK:PROFile:PBCH:PWRBoost
[ :SENSE ] :CEVM:DLINK:PROFile:PCFich
[ :SENSE ] :CEVM:DLINK:PROFile:PCFich:PWRBoost
[ :SENSE ] :CEVM:DLINK:PROFile:PDCCh
[ :SENSE ] :CEVM:DLINK:PROFile:PDCCh:ALLocation:AUTO[:DETect]
[ :SENSE ] :CEVM:DLINK:PROFile:PDCCh:ALLocation:CONSTant
[ :SENSE ] :CEVM:DLINK:PROFile:PDCCh:ALLocation:SUBFrame{0:9}:SYMBOLs
[ :SENSE ] :CEVM:DLINK:PROFile:PDCCh:PWRBoost
[ :SENSE ] :CEVM:DLINK:PROFile:PDCCh:PWRBoost:STEP
[ :SENSE ] :CEVM:DLINK:PROFile:PHICH
[ :SENSE ] :CEVM:DLINK:PROFile:PHICH:ALLocation:RATio
[ :SENSE ] :CEVM:DLINK:PROFile:PHICH:DESPread
[ :SENSE ] :CEVM:DLINK:PROFile:PHICH:DURation
[ :SENSE ] :CEVM:DLINK:PROFile:PHICH:MIDefinition
[ :SENSE ] :CEVM:DLINK:PROFile:PHICH:PWRBoost
[ :SENSE ] :CEVM:DLINK:PROFile:PHICH:PWRBoost:STEP
[ :SENSE ] :CEVM:DLINK:PROFile:PMCH
[ :SENSE ] :CEVM:DLINK:PROFile:PMCH:SUBFrame{1:9}:ACTive
```

```

[:SENSE]:CEVM:DLINK:PROFile:PMCH:SUBFrame{1:9}:MODulation:TYPE
[:SENSE]:CEVM:DLINK:PROFile:PMCH:SUBFrame{1:9}:PWRBoost
[:SENSE]:CEVM:DLINK:PROFile:PRS
[:SENSE]:CEVM:DLINK:PROFile:PRS:ACTive
[:SENSE]:CEVM:DLINK:PROFile:PRS:BANDwidth
[:SENSE]:CEVM:DLINK:PROFile:PRS:INDex
[:SENSE]:CEVM:DLINK:PROFile:PRS:PWRBoost
[:SENSE]:CEVM:DLINK:PROFile:PRS:SUBFrame:NUMBer
[:SENSE]:CEVM:DLINK:PROFile:PSS
[:SENSE]:CEVM:DLINK:PROFile:PSS:PWRBoost
[:SENSE]:CEVM:DLINK:PROFile:QAM16:RNTI
[:SENSE]:CEVM:DLINK:PROFile:QAM16:UERS:ACTive
[:SENSE]:CEVM:DLINK:PROFile:QAM16:UERS:PORT
[:SENSE]:CEVM:DLINK:PROFile:QAM16:UERS:PWRBoost
[:SENSE]:CEVM:DLINK:PROFile:QAM16:UERS:SCID
[:SENSE]:CEVM:DLINK:PROFile:QAM64:RNTI
[:SENSE]:CEVM:DLINK:PROFile:QAM64:UERS:ACTive
[:SENSE]:CEVM:DLINK:PROFile:QAM64:UERS:PORT
[:SENSE]:CEVM:DLINK:PROFile:QAM64:UERS:PWRBoost
[:SENSE]:CEVM:DLINK:PROFile:QAM64:UERS:SCID
[:SENSE]:CEVM:DLINK:PROFile:QPSK [:SENSE]:CEVM:DLINK:PROFile:QPSK:RNTI
[:SENSE]:CEVM:DLINK:PROFile:QPSK:UERS:ACTive
[:SENSE]:CEVM:DLINK:PROFile:QPSK:UERS:PORT
[:SENSE]:CEVM:DLINK:PROFile:QPSK:UERS:PWRBoost
[:SENSE]:CEVM:DLINK:PROFile:QPSK:UERS:SCID
[:SENSE]:CEVM:DLINK:PROFile:RS
[:SENSE]:CEVM:DLINK:PROFile:RS:PWRBoost
[:SENSE]:CEVM:DLINK:PROFile:SSS
[:SENSE]:CEVM:DLINK:PROFile:SSS:PWRBoost
[:SENSE]:CEVM:DLINK:PROFile:USER{1:50}:DECoded:PDSCh
[:SENSE]:CEVM:DLINK:PROFile:USER{1:50}:DECoded:PDSCh:CWONE:ENABLE
[:SENSE]:CEVM:DLINK:PROFile:USER{1:50}:DECoded:PDSCh:CWONE:PWRBoost
[:SENSE]:CEVM:DLINK:PROFile:USER{1:50}:DECoded:PDSCh:CWZero:ENABLE
[:SENSE]:CEVM:DLINK:PROFile:USER{1:50}:DECoded:PDSCh:CWZero:PWRBoost
[:SENSE]:CEVM:DLINK:PROFile:USER{1:50}:DECoded:PDSCh:EPRE
[:SENSE]:CEVM:DLINK:PROFile:USER{1:50}:DELete
[:SENSE]:CEVM:DLINK:PROFile:USER{1:50}:PDSCh:ADD:ALLocation
[:SENSE]:CEVM:DLINK:PROFile:USER{1:50}:PDSCh:ALLocation{1:50}:CWONE:
MODulation

[:SENSE]:CEVM:DLINK:PROFile:USER{1:50}:PDSCh:ALLocation{1:50}:RB
[:SENSE]:CEVM:DLINK:PROFile:USER{1:50}:PDSCh:ALLocation{1:50}:SLOT
[:SENSE]:CEVM:DLINK:PROFile:USER{1:50}:PDSCh:CBINDEX
[:SENSE]:CEVM:DLINK:PROFile:USER{1:50}:PDSCh:CDD
[:SENSE]:CEVM:DLINK:PROFile:USER{1:50}:PDSCh:COUNT?
[:SENSE]:CEVM:DLINK:PROFile:USER{1:50}:PDSCh:CWONE
[:SENSE]:CEVM:DLINK:PROFile:USER{1:50}:PDSCh:CWONE:ENABLE
[:SENSE]:CEVM:DLINK:PROFile:USER{1:50}:PDSCh:CWONE:MODulation
[:SENSE]:CEVM:DLINK:PROFile:USER{1:50}:PDSCh:CWONE:MODulation:TYPE

```

LTE-FDD Programming Commands
CEVM

```
[ :SENSE ] :CEVM:DLINK:PROFile:USER{1:50}:PDSCh:CWONe:MODulation:TYPE:COUple
[ :SENSE ] :CEVM:DLINK:PROFile:USER{1:50}:PDSCh:CWONe:PWRBoost
[ :SENSE ] :CEVM:DLINK:PROFile:USER{1:50}:PDSCh:CWONe:PWRBoost:COUple
[ :SENSE ] :CEVM:DLINK:PROFile:USER{1:50}:PDSCh:CWZero
[ :SENSE ] :CEVM:DLINK:PROFile:USER{1:50}:PDSCh:CWZero:ENABle
[ :SENSE ] :CEVM:DLINK:PROFile:USER{1:50}:PDSCh:EPRE
[ :SENSE ] :CEVM:DLINK:PROFile:USER{1:50}:PDSCh:EPRE:COUple
[ :SENSE ] :CEVM:DLINK:PROFile:USER{1:50}:PDSCh:FINDeX
[ :SENSE ] :CEVM:DLINK:PROFile:USER{1:50}:PDSCh:FINDeX:COUple
[ :SENSE ] :CEVM:DLINK:PROFile:USER{1:50}:PDSCh:MODulation
[ :SENSE ] :CEVM:DLINK:PROFile:USER{1:50}:PDSCh:MODulation:TYPE
[ :SENSE ] :CEVM:DLINK:PROFile:USER{1:50}:PDSCh:MODulation:TYPE:COUple
[ :SENSE ] :CEVM:DLINK:PROFile:USER{1:50}:PDSCh:NCODewords
[ :SENSE ] :CEVM:DLINK:PROFile:USER{1:50}:PDSCh:NLAYers
[ :SENSE ] :CEVM:DLINK:PROFile:USER{1:50}:PDSCh:PRECoding
[ :SENSE ] :CEVM:DLINK:PROFile:USER{1:50}:PDSCh:PWRBoost
[ :SENSE ] :CEVM:DLINK:PROFile:USER{1:50}:PDSCh:PWRBoost:COUple
[ :SENSE ] :CEVM:DLINK:PROFile:USER{1:50}:PDSCh:RBALloc{1:250}
[ :SENSE ] :CEVM:DLINK:PROFile:USER{1:50}:PDSCh:RBALloc{1:250}:CWONe
[ :SENSE ] :CEVM:DLINK:PROFile:USER{1:50}:PDSCh:RBALloc{1:250}:CWONe:MODulation
[ :SENSE ] :CEVM:DLINK:PROFile:USER{1:50}:PDSCh:RBALloc{1:250}:CWONe:
MODulation:TYPE
```

```
[ :SENSE ] :CEVM:DLINK:PROFile:USER{1:50}:PDSCh:RBALloc{1:250}:CWONe:PWRBoost
[ :SENSE ] :CEVM:DLINK:PROFile:USER{1:50}:PDSCh:RBALloc{1:250}:DELeTe
[ :SENSE ] :CEVM:DLINK:PROFile:USER{1:50}:PDSCh:RBALloc{1:250}:EPRE
[ :SENSE ] :CEVM:DLINK:PROFile:USER{1:50}:PDSCh:RBALloc{1:250}:FINDeX
[ :SENSE ] :CEVM:DLINK:PROFile:USER{1:50}:PDSCh:RBALloc{1:250}:MODulation
[ :SENSE ] :CEVM:DLINK:PROFile:USER{1:50}:PDSCh:RBALloc{1:250}:MODulation:TYPE
[ :SENSE ] :CEVM:DLINK:PROFile:USER{1:50}:PDSCh:RBALloc{1:250}:PWRBoost
[ :SENSE ] :CEVM:DLINK:PROFile:USER{1:50}:PDSCh:RBALloc{1:250}:RB
[ :SENSE ] :CEVM:DLINK:PROFile:USER{1:50}:PDSCh:RBALloc{1:250}:RB:END
[ :SENSE ] :CEVM:DLINK:PROFile:USER{1:50}:PDSCh:RBALloc{1:250}:RB:START
[ :SENSE ] :CEVM:DLINK:PROFile:USER{1:50}:PDSCh:RBALloc{1:250}:SLOT
[ :SENSE ] :CEVM:DLINK:PROFile:USER{1:50}:PDSCh:RBALloc{1:250}:SLOT:END
[ :SENSE ] :CEVM:DLINK:PROFile:USER{1:50}:PDSCh:RBALloc{1:250}:SLOT:START
[ :SENSE ] :CEVM:DLINK:PROFile:USER{1:50}:RNTI
[ :SENSE ] :CEVM:DLINK:PROFile:USER{1:50}:UERS
[ :SENSE ] :CEVM:DLINK:PROFile:USER{1:50}:UERS:ACTive
[ :SENSE ] :CEVM:DLINK:PROFile:USER{1:50}:UERS:PORT
[ :SENSE ] :CEVM:DLINK:PROFile:USER{1:50}:UERS:PWRBoost
[ :SENSE ] :CEVM:DLINK:PROFile:USER{1:50}:UERS:SCID
[ :SENSE ] :CEVM:DLINK:RESult
[ :SENSE ] :CEVM:DLINK:RESult:ALL
[ :SENSE ] :CEVM:DLINK:SYNC
[ :SENSE ] :CEVM:DLINK:SYNC:ANTenna
[ :SENSE ] :CEVM:DLINK:SYNC:ANTenna:DETeCt
[ :SENSE ] :CEVM:DLINK:SYNC:ANTenna:DETeCt:THReShold
[ :SENSE ] :CEVM:DLINK:SYNC:ANTenna:INACTive
```

```
[ :SENSE] :CEVM:DLINK:SYNC:ANTenna:INACTIVE:PATHs  
[ :SENSE] :CEVM:DLINK:SYNC:ANTenna:NUMBER  
[ :SENSE] :CEVM:DLINK:SYNC:ANTenna:PORT  
[ :SENSE] :CEVM:DLINK:SYNC:ANTenna:PORT:AUTO  
[ :SENSE] :CEVM:DLINK:SYNC:CID  
[ :SENSE] :CEVM:DLINK:SYNC:CID:AUTO  
[ :SENSE] :CEVM:DLINK:SYNC:CPLength  
[ :SENSE] :CEVM:DLINK:SYNC:MIMO  
[ :SENSE] :CEVM:DLINK:SYNC:MIMO:DECoding  
[ :SENSE] :CEVM:DLINK:SYNC:RSPRs  
[ :SENSE] :CEVM:DLINK:SYNC:SS  
[ :SENSE] :CEVM:DLINK:SYNC:SS:ANTenna  
[ :SENSE] :CEVM:DLINK:SYNC:SS:ANTenna:PORT  
[ :SENSE] :CEVM:DLINK:SYNC:TYPE  
[ :SENSE] :CEVM:DLINK:UERS  
[ :SENSE] :CEVM:DLINK:UERS:CFRCompen
```

LTE-FDD Programming Commands
CEVM

CEVM results (general)

Index	Result Parameter
0	Overall Pass/Fail Result 0:Pass, 1:Fail, -1:Not tested
1	EVM (%rms)
2	EVM Sym Time Adjust
3	EVM Pk (%)
4	EVM Pk Index
5	EVM Peak Sub Car Index
6	Data EVM (%rms) – Not available when Detection is Manual and no User is added.
7	3GPP-defined QPSK EVM (%rms)
8	3GPP-defined 16QAM EVM (%rms)
9	3GPP-defined 64QAM EVM (%rms)
10	RS EVM (%rms)
11	RS Tx. Power (dBm)
12	OFDM Sym. Tx. Power (dBm)
13	Freq Error (Hz)
14	Sync Corr (%)
15	Sync Type
16	Common Tracking Error (%rms)
17	Symbol Clock Error (ppm)
18	Time Offset(s)
19	IQ Offset (dB)
20	IQ Gain Imbalance (dB)
21	IQ Quad Error (deg)
22	IQ Timing Skew (s)
23	CP Length Mode
24	Cell ID
25	Cell ID Group/Sector
26	RS-OS/PRS
27	Reference Signal Rx Power (Avg)

Index	Result Parameter
28	Reference Signal Rx Quality
29	Magnitude Error (%)
30	Phase Error (radians)

CEVM results (Spectrum Flatness Equalizer Channel Frequency)

These results are part of LTE FDD CEVM measurement, and they can be queried by
`:MEAS|:READ|:FETCh:LSEQuencer:ACQuire{1:512}:ASTep{1:1000}:SFLatness[:ECFRequency]?`

Index	Result Parameter
0	Results Length - The total length of the results (includes the length field itself), currently fixed to 610
1	RP 1 Pass/Fail Result - 0:Pass, 1:Fail, -1:Not tested
2	RP 1 Value - maximum Ripple in Range 1
3	RP 2 Pass/Fail Result - 0:Pass, 1:Fail, -1:Not tested
4	RP 2 Value - maximum Ripple in Range 2
5	RP 12 Pass/Fail Result - 0:Pass, 1:Fail, -1:Not tested
6	RP 12 Value - the maximum ripple between the upper side of Range 1 and lower side of Range 2
7	RP 21 Pass/Fail Result - 0:Pass, 1:Fail, -1:Not tested
8	RP 21 Value - the maximum ripple between the upper side of Range 2 and lower side of Range 1
9	Number of subcarriers
10 - 609	600 Equalizer Coefficients - EC(f). Only the first Num_Of_SubCarriers values are valid

CEVM results (Spectrum Flatness Ripple)

These results are part of LTE FDD CEVM measurement, and they can be queried by
`:MEAS|:READ|:FETCh:LSEQuencer:ACQuire{1:512}:ASTep{1:1000}:SFLatness:RIPPLe?`

Index	Result Parameter
0	Results Length - The total length of the results (includes the length field itself), currently fixed to 9
1	RP 1 Value - maximum Ripple in Range 1
2	RP 2 Value - maximum Ripple in Range 2

Index	Result Parameter
3	RP 12 Value - the maximum ripple between the upper side of Range 1 and lower side of Range 2
4	RP 21 Value - the maximum ripple between the upper side of Range 2 and lower side of Range 1
5	Min Ec(f)1 - the minimum EC(f) in Range 1
6	Max Ec(f)1 - the maximum EC(f) in Range 1
7	Min Ec(f)2 - the minimum EC(f) in Range 2
8	Max Ec(f)2 - the maximum EC(f) in Range 2

CEVM results (Inband Emission Power)

These results are part of LTE FDD CEVM measurement, and they can be queried by
:MEAS|:READ|:FETCh:LSEQuencer:ACQuire{1:512}:ASTep{1:1000}:IEMission[:POWer]?

Index	Result Parameter
0	Results Length - The total length of the results (includes the length field itself), currently fixed to 53
1	Average Power of Active RBs - the average absolute power of allocated RBs in dBm
2	Number of RBs - the number of RBs in current configuration
3 - 52	Power Per RB - the absolute power (dBm) per RB. Only the first Number_OF_RB values are valid.

CEVM Results (Inband Emission Margin)

These results are part of LTE FDD CEVM measurement, and they can be queried by
:MEAS|:READ|:FETCh:LSEQuencer:ACQuire{1:512}:ASTep{1:1000}:IEMission:MARGIN?

Index	Result Parameter
0	Results Length - The total length of the results (includes the length field itself), currently fixed to 54
1	Minimal Inband Margin - Inband margin is the difference between the inband emission limit mask and actual measured power per non-allocated RB. The margin = (Limit - Power) in dB. A negative margin indicates that the power exceeds the limit.
2	Minimal Inband Margin Index - the RB index of minimal margin results (ZERO based)
3	Number of RBs - the number of RBs in current configuration
4 - 53	Inband Margin per RB - The Margin result of each RB. (only the first Num_of_RB values are valid). If the RB is active (allocated), the inband margin result will be set to NAN.

CEVM results (Detected Slot Number)

These results are part of LTE FDD CEVM measurement, and they can be queried by
:MEAS|:READ|:FETCh:LSEQuencer:ACQuire{1:512}:ASTep{1:1000}:SLOT[:DETECT]?

There is only one value returned, which represents the actually detected slot number of LTE Modulation Accuracy.

CEVM results (Timing Offset Per Antenna)

These results are part of LTE FDD CEVM measurement, and they can be queried by
:MEAS|:READ|:FETCh:LSEQuencer:ACQuire{1:512}:ASTep{1:1000}:TOPA?

The number of elements in this result varies with the number of C-RS ports and Number of input channels(Rx). For example, if the number of C-RS ports is 4, and the number of input channels is 2, the result contains 8 elements. Each element in the result means the average timing error of the cell-specific reference signal for a C-RS Cell-specific RS/Rx path.

Index	Result Parameter
0~M*N-1	The average timing error of the cell-specific reference signal for M*N C-RS Cell-specific RS/Rx path.

16 LTE-TDD Programming Commands

This chapter lists all the commands used to set up the LTE-TDD measurements from within the List Sequencer.

The chapter topics are:

- Power vs. Time (PvT)
- Adjacent Channel Power (ACP)
- Spectrum Emissions Mask (SEM)
- Occupied Bandwidth (OBW)
- CEVM

Power vs. Time (PvT)

This section provides the remote control SCPI commands for the LTE-TDD Power vs. Time (PvT) measurement from within the List Sequencer. This measurement is available only if you have the LTE-TDD measurement application licensed on the test set.

For more detailed information about the PvT measurement, refer to the online help associated with the LTE-TDD measurement application, which is also available in PDF format (“User’s and Programmer’s Reference”) on the Keysight website, www.keysight.com/find/e6650a.

You can also refer to the measurement guide for the X-series LTE-TDD measurement application, which is available on the Keysight website, www.keysight.com/find/mxa.

Power vs. Time (PvT) measurement SCPI commands

There is a set of SCPI commands available to program the LTE-TDD PvT measurement when it is used in the LTE-TDD mode. To set up the GSM measurements from within the Sequence Analyzer mode you need to prefix the SCPI commands with `LSEQuencer:LTETdd`. For example, the `[:SENSE]:PVTime` part of the LTE-TDD PvT SCPI commands are replaced with `[:SENSE]:LSEQuencer:LTETdd:PVTime`.

The following commands are used to set up the LTE-TDD PvT measurement.

```
[:SENSE]:LSEQuencer:LTETdd:RADio:STANdard:PRESet B1M4|B3M|B5M|B10M|B15M|B20M
[:SENSE]:LSEQuencer:LTETdd:RADio:STANdard:PRESet?
[:SENSE]:LSEQuencer:LTETdd:PVTime:BANdwidth <freq>
[:SENSE]:LSEQuencer:LTETdd:PVTime:BANdwidth?
[:SENSE]:LSEQuencer:LTETdd:PVTime:RAMP:SEARch:LENGth <time>
[:SENSE]:LSEQuencer:LTETdd:PVTime:RAMP:SEARch:LENGth?
[:SENSE]:LSEQuencer:LTETdd:PVTime:LIMit:RAMP:URTime <time>
[:SENSE]:LSEQuencer:LTETdd:PVTime:LIMit:RAMP:URTime?
[:SENSE]:LSEQuencer:LTETdd:PVTime:LIMit:RAMP:DRTime <time>
[:SENSE]:LSEQuencer:LTETdd:PVTime:LIMit:RAMP:DRTime?
[:SENSE]:LSEQuencer:LTETdd:PVTime:LIMit:POFF:ULINK <real>
[:SENSE]:LSEQuencer:LTETdd:PVTime:LIMit:POFF:ULINK?
{:SENSE}:LSEQuencer:LTETdd:PVTime:THReshold:UP:STARt <rel_ampl>
[:SENSE]:LSEQuencer:LTETdd:PVTime:THReshold:UP:STARt?
[:SENSE]:LSEQuencer:LTETdd:PVTime:THReshold:UP:END <rel_ampl>
[:SENSE]:LSEQuencer:LTETdd:PVTime:THReshold:UP:END?
[:SENSE]:LSEQuencer:LTETdd:PVTime:THReshold:DOWN:STARt <rel_ampl>
[:SENSE]:LSEQuencer:LTETdd:PVTime:THReshold:DOWN:STARt?
[:SENSE]:LSEQuencer:LTETdd:PVTime:THReshold:DOWN:END <rel_ampl>
```

[:SENSe] :LSEQuencer :LTETdd :PVTime :THReshold :DOWN :END?

[:SENSe] :LSEQuencer :LTETdd :RADio :SLOT

TS0 | TS1 | TS2 | TS3 | TS4 | TS5 | TS6 | TS7 | TS8 | TS9 | TS10 | TS11 | TS12 | TS13 | TS14 | TS15 | TS16 | TS17 | TS18 | TS19

[:SENSe] :LSEQuencer :LTETdd :RADio :SLOT?

[:SENSe] :LSEQuencer :LTETdd :RADio :MINTerval <integer>

[:SENSe] :LSEQuencer :LTETdd :RADio :MINTerval?

LTE-TDD Programming Commands
Power vs. Time (PvT)

PvT results

Index	Result Parameter
0	Overall Pass/Fail Result shows the mask test result (0.0 = pass, 1.0 = fail, -1.0: Not tested)
1	Ramp Up Time Pass/Fail Result shows ramp up time limit test result. The time mask defines the ramping up time allowed for the UE between transmit OFF power and transmit ON power.
2	Ramp Down Time Pass/Fail Result shows ramp down time limit test result. The time mask defines the ramping down time allowed for the UE between transmit ON power and transmit OFF power.
3	Off Power Before Pass/Fail Result shows uplink transmit off power limit test result which occurs before the burst.
4	Off Power After Pass/Fail Result show uplink transmit off power limit test result which occurs after the burst.
5	On Power/Mean Power Result is the mean power (in dBm) of the active part in the range specified by Analysis Time Slot and Measured Time Slots in the most recently acquired data, or in the last data acquired at the end of a set of average.
6	Burst Width Result is the width of continuous active slots in the range specified by Analysis Time slot and Measured Time Slots.
7	Trigger Diff Result is the time difference between the position of the trigger line and the start point of the detected burst. (This result is NaN 9.91E+37 when trigger is Video Trigger or Free Run.)
8	Ramp Up Time Result is the time difference between 10% and 90% voltage points (relative to peak) on the positive slope of the burst, here burst has the same meaning in Burst width.
9	Ramp Down Time Result is the time difference between 90% and 10% voltage points (relative to peak) on the negative slope of the burst, here burst has the same meaning in Burst width.
10	Off Power/Off Power Before Result is the mean power measured during the transmitter OFF period, When Direction is Uplink, this result is the OFF power during the sub-frame prior to the active sub-frame.
11	Off Power After Result is the OFF power during the sub-frame following the active burst.
12	Maximum Power Result is maximum peak level in the range specified by Analysis Time Slot and Measured Time Slots (in dBm).
13	Minimum Power Result is the minimum peak level in the range specified by Analysis Time Slot and Measured Time Slots (in dBm).
14	Actual Sample Interval Result is a floating point number representing the time between samples of uncompressed I/Q trace data.
15	Actual Number of Samples Result is the number of data points in the uncompressed I/Q trace data.

16	Trace Sample Interval Result is a floating point number representing the time between samples of compressed/decimated I/Q trace data which could be got by trace query.
17	Number of Trace Samples Result is the number of data points in the compressed/decimated I/Q trace data which could be got by trace query.

The following command is used to retrieve the measurement trace:

MEAS | READ | FETCh:LSEQuencer:ACQuire{1...512}:ASTep{1...1000}:LTETdd:PVT:TRACe

This command returns acquired I/Q trace data used in analysis step interval as a series of comma-separated trace point values. The I values are listed in each pair, using 0 through even-indexed values. The Q values are odd-indexed values. At most 2000 sample data can be returned (one sample contains one I data and one Q data). If the actual number of samples exceeds 2000, then actual trace data will be compressed/decimated to 2000 and be returned as the trace data.

Example command:

FETCh:LSEQ:ACQ1:ASTep1:LTETdd:PVT:TRACe?

Adjacent Channel Power (ACP)

This section provides the remote control SCPI commands for the LTE-TDD Adjacent Channel Power (ACP) measurement from within the List Sequencer. This measurement is available only if you have the LTE-TDD measurement application licensed on the test set.

For more detailed information about the ACP measurement, refer to the online help associated with the LTE-TDD measurement application, which is also available in PDF format (“User’s and Programmer’s Reference”) on the Keysight website, www.keysight.com/find/e6650a.

You can also refer to the measurement guide for the X-series LTE-TDD measurement application, which is available on the Keysight website, www.keysight.com/find/mxa.

Adjacent Channel Power (ACP) measurement SCPI commands

There is a set of SCPI commands available to program the LTE-TDD ACP measurement when it is used in the LTE-TDD mode. To set up the LTE-TDD measurements from within the Sequence Analyzer mode you need to prefix the SCPI commands with `LSEQuencer:LTETdd`. For example, the `[:SENSe] :ACPower` part of the ACP SCPI commands are replaced with `[:SENSe] :LSEQuencer:LTETdd:ACPower`.

The following commands are used to set up the ACP measurement.

```
[ :SENSe ] :LSEQuencer:LTETdd:ACPower:BANDwidth [ :RESolution ]
[ :SENSe ] :LSEQuencer:LTETdd:ACPower:BANDwidth:SHAPE
[ :SENSe ] :LSEQuencer:LTETdd:ACPower:BANDwidth:TYPE
[ :SENSe ] :LSEQuencer:LTETdd:ACPower:CARRier [ 1 ] | 2 :COUNT
[ :SENSe ] :LSEQuencer:LTETdd:ACPower:CARRier [ 1 ] | 2 :REFerence
[ :SENSe ] :LSEQuencer:LTETdd:ACPower:CARRier [ 1 ] | 2 :RCARRier:AUTO
[ :SENSe ] :LSEQuencer:LTETdd:ACPower:CARRier [ 1 ] | 2 :RCFrequency
[ :SENSe ] :LSEQuencer:LTETdd:ACPower:CARRier [ 1 ] | 2 :RCFrequency:AUTO
[ :SENSe ] :LSEQuencer:LTETdd:ACPower:CARRier [ 1 ] | 2 [ :POWER ]
[ :SENSe ] :LSEQuencer:LTETdd:ACPower:CARRier [ 1 ] | 2 :AUTO [ :STATe ]
[ :SENSe ] :LSEQuencer:LTETdd:ACPower:CARRier [ 1 ] | 2 :CPSD
[ :SENSe ] :LSEQuencer:LTETdd:ACPower:CARRier [ 1 ] | 2 :LIST:COUPlE
[ :SENSe ] :LSEQuencer:LTETdd:ACPower:CARRier [ 1 ] | 2 :LIST:PPResent
[ :SENSe ] :LSEQuencer:LTETdd:ACPower:CARRier [ 1 ] | 2 :LIST:WIDTh
[ :SENSe ] :LSEQuencer:LTETdd:ACPower:CARRier [ 1 ] | 2 :LIST:
BANDwidth [ :INTegration ]
[ :SENSe ] :LSEQuencer:LTETdd:ACPower:CARRier [ 1 ] | 2 :LIST:METHod
[ :SENSe ] :LSEQuencer:LTETdd:ACPower:CARRier [ 1 ] | 2 :LIST:FILTer:ALPHA
[ :SENSe ] :LSEQuencer:LTETdd:ACPower:OFFSet [ 1 ] | 2 :LIST [ :FREQuency ]
```

```
[ :SENSE ] :LSEQuencer :LTETdd :ACPpower :OFFSet [ 1 ] | 2 :LIST :STATE
[ :SENSe ] :LSEQuencer :LTETdd :ACPpower :OFFSet [ 1 ] | 2 :LIST :BANDwidth
[ :SENSe ] :LSEQuencer :LTETdd :ACPpower :OFFSet [ 1 ] | 2 :LIST :BANDwidth :RESolution
[ :SENSe ] :LSEQuencer :LTETdd :ACPpower :OFFSet [ 1 ] | 2 :LIST :BANDwidth :
RESolution :AUTO
[ :SENSe ] :LSEQuencer :LTETdd :ACPpower :OFFSet [ 1 ] | 2 :LIST :BANDwidth :SHAPE
[ :SENSe ] :LSEQuencer :LTETdd :ACPpower :OFFSet [ 1 ] | 2 :LIST :BANDwidth :TYPE
[ :SENSe ] :LSEQuencer :LTETdd :ACPpower :OFFSet [ 1 ] | 2 :LIST :ABSolute
[ :SENSe ] :LSEQuencer :LTETdd :ACPpower :OFFSet [ 1 ] | 2 :LIST :TEST
[ :SENSe ] :LSEQuencer :LTETdd :ACPpower :OFFSet [ 1 ] | 2 :LIST :RCARrier
[ :SENSe ] :LSEQuencer :LTETdd :ACPpower :OFFSet [ 1 ] | 2 :LIST :RPSDensity
```

ACP results

Index	Result Parameter
0	Overall Pass/Fail result - returns 24 scalar values of the pass/fail (0.0 = pass, 1.0 = fail) determined by testing the relative to the reference carrier and by testing the absolute power limit of the offset frequencies (measured as total power in dBm)
	1. Lower Offset A - relative limit test result
	2. Lower Offset A - absolute limit test result
	3. Upper Offset A - relative limit test result
	4. Upper Offset A - absolute limit test result
	5. Lower Offset B - relative limit test result
	6. Lower Offset B - absolute limit test result
	7. Upper Offset B - relative limit test result
	8. Upper Offset B - absolute limit test result
	...
	21. Lower Offset F - relative limit test result
	22. Lower Offset F - absolute limit test result
	23. Upper Offset F - relative limit test result
	24. Upper Offset F - absolute limit test result

LTE-TDD Programming Commands
 Adjacent Channel Power (ACP)

1	<p>Carrier Powers - returns three scalar values representing overall pass/fail, carrier power, and reference carrier power</p> <ol style="list-style-type: none"> 1. Overall Pass/Fail 2. Total Carrier Power 3. Reference Carrier Power <p>If meas type is Total Power Reference, these results are returned in units of dBm. If Meas Type is Power Spectral Density Reference, these results are returned in units of dBm/Hz or dBm/MHz.</p>
2	<p>Power Results</p> <ol style="list-style-type: none"> 1. Channel (1) - relative power 2. Channel (1) - absolute power 3. Channel (1) - relative power 4. Channel (1) - absolute power ... 23. Channel (1) - relative power 24. Channel (1) - absolute power 25. Lower Offset A - relative power 26. Lower Offset A - absolute power 27. Upper Offset A - relative power 28. Upper Offset A - absolute power 29. Lower Offset B - relative power 30. Lower Offset B - absolute power 31. Upper Offset B - relative power 32. Upper Offset B - absolute power ... 45. Lower Offset F - relative power 46. Lower Offset F - absolute power 47. Upper Offset F - relative power 48. Upper Offset F - absolute power <p>If Meas Type is Total Power Reference, these results are returned in units of dBm. If Meas Type is Power Spectral Density Reference, these results are returned in units of dBm/Hz or dBm/MHz.</p>

Spectrum Emissions Mask (SEM)

This section provides the remote control SCPI commands for the LTE-TDD Spectrum Emissions Mask (SEM) measurement from within the List Sequencer. This measurement is available only if you have the LTE-TDD measurement application licensed on the test set.

For more detailed information about the SEM measurement, refer to the online help associated with the LTE-TDD measurement application, which is also available application, which is also available in PDF format (“User’s and Programmer’s Reference”) on the Keysight website, www.keysight.com/find/e6650a.

You can also refer to the measurement guide for the X-series LTE-TDD measurement application, which is available on the Keysight website, www.keysight.com/find/mxa.

SEM measurement SCPI commands

There is a set of SCPI commands available to program the LTE-TDD SEM measurement when it is used in the LTE-TDD mode. To set up the LTE-TDD measurements from within the Sequence Analyzer mode you need to prefix the SCPI commands with `LSEQuencer:LTETdd`. For example, the `[:SENSe]:SEMAsk` part of the SEM SCPI commands are replaced with:

```
[:SENSe]:LSEQuencer:LTETdd:SEMAsk
```

The following commands are used to set up the SEM measurement.

```
[:SENSe]:LSEQuencer:LTETdd:SEMAsk:TYPE
```

```
[:SENSe]:LSEQuencer:LTETdd:SEMAsk:BANDwidth[1]|2:INTegration
```

```
[:SENSe]:LSEQuencer:LTETdd:SEMAsk:FREQuency[1]|2:SPAN
```

```
[:SENSe]:LSEQuencer:LTETdd:SEMAsk:BANDwidth[1]|2:[:RESolution]
```

```
[:SENSe]:LSEQuencer:LTETdd:SEMAsk:BANDwidth[1]|2:[:RESolution]:AUTO
```

```
[:SENSe]:LSEQuencer:LTETdd:SEMAsk:CARRier[:POWER]
```

```
[:SENSe]:LSEQuencer:LTETdd:SEMAsk:CARRier:AUTO[:STATe]
```

```
[:SENSe]:LSEQuencer:LTETdd:SEMAsk:CARRier:CPSD
```

```
[:SENSe]:LSEQuencer:LTETdd:SEMAsk:CARRier:PEAK[:POWER]
```

```
[:SENSe]:LSEQuencer:LTETdd:SEMAsk:OFFSet[1]|2:LIST:FREQuency:START
```

```
[:SENSe]:LSEQuencer:LTETdd:SEMAsk:OFFSet[1]|2:LIST:STATe
```

```
[:SENSe]:LSEQuencer:LTETdd:SEMAsk:OFFSet[1]|2:LIST:FREQuency:STOP
```

```
[:SENSe]:LSEQuencer:LTETdd:SEMAsk:OFFSet[1]|2:LIST:SIDE
```

```
[:SENSe]:LSEQuencer:LTETdd:SEMAsk:OFFSet[1]|2:LIST:BANDwidth[:RESolution]
```

```
[:SENSe]:LSEQuencer:LTETdd:SEMAsk:OFFSet[1]|2:LIST:BANDwidth[:RESolution]:AUTO
```

```
[:SENSe]:LSEQuencer:LTETdd:SEMAsk:OFFSet[1]|2:LIST:BANDwidth:IMULti
```

```
[:SENSe]:LSEQuencer:LTETdd:SEMAsk:OFFSet[1]|2:LIST:START:ABSolute
```

LTE-TDD Programming Commands

Spectrum Emissions Mask (SEM)

```
[ :SENSe ] :LSEQuencer :LTETdd :SEMAsk :OFFSet [ 1 ] | 2 :LIST :STOP :ABSolute  
[ :SENSe ] :LSEQuencer :LTETdd :SEMAsk :OFFSet [ 1 ] | 2 :LIST :STOP :ABSoluteCOUple  
[ :SENSe ] :LSEQuencer :LTETdd :SEMAsk :OFFSet [ 1 ] | 2 :LIST :START :RCARrier  
[ :SENSe ] :LSEQuencer :LTETdd :SEMAsk :OFFSet [ 1 ] | 2 :LIST :STOP :RCARrier  
[ :SENSe ] :LSEQuencer :LTETdd :SEMAsk :OFFSet [ 1 ] | 2 :LIST :STOP :RCARrier :COUple  
[ :SENSe ] :LSEQuencer :LTETdd :SEMAsk :OFFSet [ 1 ] | 2 :LIST :TEST  
[ :SENSe ] :LSEQuencer :LTETdd :SEMAsk :FILTer [ :RRC ] [ :STATe ]  
[ :SENSe ] :LSEQuencer :LTETdd :SEMAsk :FILTer [ :RRC ] :ALPHa  
[ :SENSe ] :LSEQuencer :LTETdd :SEMAsk :LIMits  
[ :SENSe ] :LSEQuencer :LTETdd :SEMAsk :TYPE  
:TRACe :LSEQuencer :LTETdd :SEMAsk :TYPE
```

SEM results

Index	Result Parameter
0	Overall Pass/Fail result shows the mask test result (0 = pass, 1 = fail, -1 not tested)
1	<p>Main Results</p> <ol style="list-style-type: none"> 1. Absolute power at center frequency (reference) area (dBm) 2. Peak Frequency in the center frequency (reference) area (Hz) 3. Relative integrated power on the negative offset A (dBc) 4. Absolute integrated power on the negative offset A (dBm or dBm/Hz) 5. Relative peak power on the negative offset A (dBc) 6. Absolute peak power on the negative offset A (dBm or dBm/Hz) 7. Peak power offset frequency from the center frequency in the negative offset A (Hz) 8. Relative integrated power on the positive offset A (dBc) 9. Absolute integrated power on the positive offset A (dBm or dBm/Hz) 10. Relative peak power on the positive offset A (dBc) 11. Absolute peak power on the positive offset A (dBm or dBm/Hz) 12. Peak power offset frequency from the center frequency in the positive offset A (Hz) 13. Relative integrated power on the negative offset B (dBc) <p>...</p> <ol style="list-style-type: none"> 61. Absolute peak power on the positive offset F (dBm or dBm/Hz) 62. Peak power offset frequency from the center frequency in the positive offset F (Hz) 63. Minimum margin from limit line on the negative offset A (dB) 64. Minimum margin from limit line on the positive offset A (dB) 65. Minimum margin from limit line on the negative offset B (dB) 66. Minimum margin from limit line on the positive offset B (dB) 67. Minimum margin from limit line on the negative offset C (dB) 68. Minimum margin from limit line on the positive offset C (dB) 69. Minimum margin from limit line on the negative offset D (dB) 70. Minimum margin from limit line on the positive offset D (dB) 71. Minimum margin from limit line on the negative offset E (dB) 72. Minimum margin from limit line on the positive offset E (dB) 73. Minimum margin from limit line on the negative offset F (dB) 74. Minimum margin from limit line on the positive offset F (dB) <p>The unit for the absolute power results varies depending on the measurement type:</p> <p>If the measurement type is Total Power Reference, these results are expressed in dBm.</p> <p>If the measurement type is Power Spectral Density Reference, these results are expressed in dBm/Hz.</p>

Occupied Bandwidth (OBW)

This section provides the remote control SCPI commands for the LTE-TDD Occupied Bandwidth (OBW) measurement from within the List Sequencer. This measurement is available only if you have the LTE-TDD measurement application licensed on the test set.

For more detailed information about the OBW measurement, refer to the online help associated with the LTE-TDD measurement application, which is also available in PDF format (“User’s and Programmer’s Reference”) on the Keysight website, www.keysight.com/find/e6650a.

You can also refer to the measurement guide for the X-series LTE-TDD measurement application, which is available on the Keysight website, www.keysight.com/find/mxa.

OBW measurement SCPI commands

There is a set of SCPI commands available to program the LTE-TDD OBW measurement when it is used in the LTE-TDD mode. To set up the LTE-TDD measurements from within the Sequence Analyzer mode you need to prefix the SCPI commands with LSEQuencer:LTETdd. For example, the [:SENSE]:OBWidth part of the OBW SCPI commands are replaced with [:SENSE]:LSEQuencer:LTETdd:OBWidth.

The following commands are used to set up the OBW measurement.

```
[:SENSE]:LSEQuencer:LTETdd:OBWidth:BANDwidth[:RESolution]
```

```
[:SENSE]:LSEQuencer:LTETdd:OBWidth:BANDwidth:SHAPE
```

```
[:SENSE]:LSEQuencer:LTETdd:OBWidth:PERCent
```

```
[:SENSE]:LSEQuencer:LTETdd:OBWidth:XDB
```

```
CALCulate: [SENSE]:LSEQuencer:LTETdd:OBWidth:LIMit:FBLimit
```

```
CALCulate: [SENSE]:LSEQuencer:LTETdd:OBWidth:LIMit[:TEST]
```

```
[:SENSE]:LSEQuencer:LTETdd:OBWidth:FREQuency:SPAN
```

```
[:SENSE]:LSEQuencer:LTETdd:OBWidth:FREQuency:SPAN:FULL
```

```
[:SENSE]:LSEQuencer:LTETdd:OBWidth:FREQuency:SPAN:PREVIOUS
```

OBW results

Index	Result Parameter
0	Overall Pass/Fail
1	Main Results 1. Occupied Band width (Hz) 2. Transmit Frequency Error (Hz) 3. x dB band width (Hz)

CEVM

This section provides the remote control SCPI commands for the LTE-TDD CEVM measurement from within the List Sequencer. This measurement is available only if you have the LTE-TDD measurement application licensed on the test set.

For more detailed information about the CEVM measurement, refer to the online help associated with the LTE-TDD measurement application, which is also available in PDF format (“User’s and Programmer’s Reference”) on the Keysight website, www.keysight.com/find/e6650a.

You can also refer to the measurement guide for the X-series LTE-TDD measurement application, which is available on Keysight website, www.keysight.com/find/mxa.

CEVM measurement SCPI commands

There is a set of SCPI commands available to program the LTE-TDD CEVM measurement when it is used in the LTE-TDD mode. To set up the LTE-TDD measurements from within the Sequence Analyzer mode you need to prefix the SCPI commands with `LSEQuencer:LTE`. For example, the `[:SENSE]:CEVM` part of the modulation accuracy SCPI commands are replaced with:

```
[:SENSE]:LSEQuencer:LTE:CEVM
```

The following commands are used to set up the modulation accuracy measurement.

```
[:SENSE]:CEVM:EETTime
[:SENSE]:CEVM:EQUalizer:TRaining
[:SENSE]:CEVM:EQUalizer:TRaining:MAFilter
[:SENSE]:CEVM:EQUalizer:TRaining:MAFilter:LENGth
[:SENSE]:CEVM:EQUalizer:TRaining:MCFNormalize
[:SENSE]:CEVM:EQUalizer:TRaining:MODE
[:SENSE]:CEVM:EVMMinimize
[:SENSE]:CEVM:EVMMinimize:AMPLitude
[:SENSE]:CEVM:EVMMinimize:FREQuency
[:SENSE]:CEVM:EVMMinimize:IQOffset
[:SENSE]:CEVM:EVMMinimize:TIMing
[:SENSE]:CEVM:EXTended:FREQuency:LOCK:RANGE
[:SENSE]:CEVM:MCFilter:STATE
[:SENSE]:CEVM:POWer:BOOST:NORMALize
[:SENSE]:CEVM:PROFile:AUTO[:DETECT]
[:SENSE]:CEVM:PROFile:NALLocation
[:SENSE]:CEVM:SYMBOL:TIMing:ADJust
[:SENSE]:CEVM:SYMBOL:TIMing:ADJust:USER
[:SENSE]:CEVM:TIME:ASBoundary
[:SENSE]:CEVM:TIME:INTerval:SLOT
[:SENSE]:CEVM:TIME:INTerval:SYMBOL
[:SENSE]:CEVM:TIME:OFFSet:SLOT
[:SENSE]:CEVM:TIME:OFFSet:SYMBOL
[:SENSE]:CEVM:TIME:RESult:LENGth
[:SENSE]:CEVM:ULINK:DECode:PUSCh
[:SENSE]:CEVM:ULINK:PROFile:ADD:USER/nquery/
[:SENSE]:CEVM:ULINK:PROFile:AUTO:CID
[:SENSE]:CEVM:ULINK:PROFile:AUTO[:DETECT]:POWer
```

LTE-TDD Programming Commands
CEVM

[:SENSE] :CEVM:ULINK:PROFile:AUTO:HOPPing:GROup
[:SENSE] :CEVM:ULINK:PROFile:AUTO:HOPPing:SEQuence
[:SENSE] :CEVM:ULINK:PROFile:AUTO:PRACH
[:SENSE] :CEVM:ULINK:PROFile:AUTO:PRACH:ACTive
[:SENSE] :CEVM:ULINK:PROFile:AUTO:PRACH:CINdex
[:SENSE] :CEVM:ULINK:PROFile:AUTO:PRACH:CSSet
[:SENSE] :CEVM:ULINK:PROFile:AUTO:PRACH:LRSindex
[:SENSE] :CEVM:ULINK:PROFile:AUTO:PRACH:NCSConfig
[:SENSE] :CEVM:ULINK:PROFile:AUTO:PRACH:PINdex
[:SENSE] :CEVM:ULINK:PROFile:AUTO:PRACH:PWRBoost
[:SENSE] :CEVM:ULINK:PROFile:AUTO:PUCCh
[:SENSE] :CEVM:ULINK:PROFile:AUTO:PUCCh:ACTive
[:SENSE] :CEVM:ULINK:PROFile:AUTO:PUCCh:CSHift
[:SENSE] :CEVM:ULINK:PROFile:AUTO:PUCCh:DMRS
[:SENSE] :CEVM:ULINK:PROFile:AUTO:PUCCh:DMRS:GROup
[:SENSE] :CEVM:ULINK:PROFile:AUTO:PUCCh:DMRS:PARams
[:SENSE] :CEVM:ULINK:PROFile:AUTO:PUCCh:DMRS:PWRBoost
[:SENSE] :CEVM:ULINK:PROFile:AUTO:PUCCh:FNPucch:AUTO
[:SENSE] :CEVM:ULINK:PROFile:AUTO:PUCCh:FORMat
[:SENSE] :CEVM:ULINK:PROFile:AUTO:PUCCh:N:ONE
[:SENSE] :CEVM:ULINK:PROFile:AUTO:PUCCh:N:TWO
[:SENSE] :CEVM:ULINK:PROFile:AUTO:PUCCh:NCS:ONE
[:SENSE] :CEVM:ULINK:PROFile:AUTO:PUCCh:NRB:TWO
[:SENSE] :CEVM:ULINK:PROFile:AUTO:PUCCh:OS
[:SENSE] :CEVM:ULINK:PROFile:AUTO:PUCCh:PWRBoost
[:SENSE] :CEVM:ULINK:PROFile:AUTO:PUCCh:RB
[:SENSE] :CEVM:ULINK:PROFile:AUTO:PUCCh:SHIFt
[:SENSE] :CEVM:ULINK:PROFile:AUTO:PUCCh:SSLot
[:SENSE] :CEVM:ULINK:PROFile:AUTO:PUCCh:SSLot:AUTO
[:SENSE] :CEVM:ULINK:PROFile:AUTO:PUSCh
[:SENSE] :CEVM:ULINK:PROFile:AUTO:PUSCh:ACTive
[:SENSE] :CEVM:ULINK:PROFile:AUTO:PUSCh:DMRS
[:SENSE] :CEVM:ULINK:PROFile:AUTO:PUSCh:DMRS:CSHift
[:SENSE] :CEVM:ULINK:PROFile:AUTO:PUSCh:DMRS:GROup
[:SENSE] :CEVM:ULINK:PROFile:AUTO:PUSCh:DMRS:ONE
[:SENSE] :CEVM:ULINK:PROFile:AUTO:PUSCh:DMRS:PARams
[:SENSE] :CEVM:ULINK:PROFile:AUTO:PUSCh:DMRS:PWRBoost
[:SENSE] :CEVM:ULINK:PROFile:AUTO:PUSCh:DMRS:SEQuence
[:SENSE] :CEVM:ULINK:PROFile:AUTO:PUSCh:DMRS:TWO
[:SENSE] :CEVM:ULINK:PROFile:AUTO:PUSCh:DSS
[:SENSE] :CEVM:ULINK:PROFile:AUTO:PUSCh:NSB
[:SENSE] :CEVM:ULINK:PROFile:AUTO:PUSCh:PWRBoost
[:SENSE] :CEVM:ULINK:PROFile:AUTO:PUSCh:RB:END
[:SENSE] :CEVM:ULINK:PROFile:AUTO:PUSCh:RB:START
[:SENSE] :CEVM:ULINK:PROFile:AUTO:PUSCh:SSLot
[:SENSE] :CEVM:ULINK:PROFile:AUTO:PUSCh:SSLot:AUTO
[:SENSE] :CEVM:ULINK:PROFile:AUTO:RNTI
[:SENSE] :CEVM:ULINK:PROFile:AUTO:SFNumber
[:SENSE] :CEVM:ULINK:PROFile:AUTO:SRS

```

[:SENSE]:CEVM:ULINK:PROfile:AUTO:SRS:ACTive
[:SENSE]:CEVM:ULINK:PROfile:AUTO:SRS:BCONfig
[:SENSE]:CEVM:ULINK:PROfile:AUTO:SRS:BWIDth
[:SENSE]:CEVM:ULINK:PROfile:AUTO:SRS:CINdex
[:SENSE]:CEVM:ULINK:PROfile:AUTO:SRS:CSHift
[:SENSE]:CEVM:ULINK:PROfile:AUTO:SRS:FDPosition
[:SENSE]:CEVM:ULINK:PROfile:AUTO:SRS:HBWidth
[:SENSE]:CEVM:ULINK:PROfile:AUTO:SRS:PWRBoost
[:SENSE]:CEVM:ULINK:PROfile:AUTO:SRS:SFConfig
[:SENSE]:CEVM:ULINK:PROfile:AUTO:SRS:SSLot
[:SENSE]:CEVM:ULINK:PROfile:AUTO:SRS:SSLot:AUTO
[:SENSE]:CEVM:ULINK:PROfile:AUTO:SRS:TCOMb
[:SENSE]:CEVM:ULINK:PROfile:CLear/nquery/
[:SENSE]:CEVM:ULINK:PROfile:COUNT?/qonly/
[:SENSE]:CEVM:ULINK:PROfile:EXCLude:ALL/nquery/
[:SENSE]:CEVM:ULINK:PROfile:INCLude:ALL/nquery/
[:SENSE]:CEVM:ULINK:PROfile:USER{1:50}:CID
[:SENSE]:CEVM:ULINK:PROfile:USER{1:50}:DELete/nquery/
[:SENSE]:CEVM:ULINK:PROfile:USER{1:50}:HOPPing:GROup
[:SENSE]:CEVM:ULINK:PROfile:USER{1:50}:HOPPing:SEQuence
[:SENSE]:CEVM:ULINK:PROfile:USER{1:50}:PRACH
[:SENSE]:CEVM:ULINK:PROfile:USER{1:50}:PRACH:ACTive
[:SENSE]:CEVM:ULINK:PROfile:USER{1:50}:PRACH:CINdex
[:SENSE]:CEVM:ULINK:PROfile:USER{1:50}:PRACH:CSSet
[:SENSE]:CEVM:ULINK:PROfile:USER{1:50}:PRACH:LRSindex
[:SENSE]:CEVM:ULINK:PROfile:USER{1:50}:PRACH:NCSConfig
[:SENSE]:CEVM:ULINK:PROfile:USER{1:50}:PRACH:NRAPrb
[:SENSE]:CEVM:ULINK:PROfile:USER{1:50}:PRACH:PINdex
[:SENSE]:CEVM:ULINK:PROfile:USER{1:50}:PRACH:PWRBoost
[:SENSE]:CEVM:ULINK:PROfile:USER{1:50}:PUCCh
[:SENSE]:CEVM:ULINK:PROfile:USER{1:50}:PUCCh:ACTive
[:SENSE]:CEVM:ULINK:PROfile:USER{1:50}:PUCCh:ADD:SLOT/nquery/
[:SENSE]:CEVM:ULINK:PROfile:USER{1:50}:PUCCh:COUNT?/qonly/
[:SENSE]:CEVM:ULINK:PROfile:USER{1:50}:PUCCh:CSHift
[:SENSE]:CEVM:ULINK:PROfile:USER{1:50}:PUCCh:CSHift:COUple
[:SENSE]:CEVM:ULINK:PROfile:USER{1:50}:PUCCh:DMRS
[:SENSE]:CEVM:ULINK:PROfile:USER{1:50}:PUCCh:DMRS:GROup
[:SENSE]:CEVM:ULINK:PROfile:USER{1:50}:PUCCh:DMRS:GROup:COUple
[:SENSE]:CEVM:ULINK:PROfile:USER{1:50}:PUCCh:DMRS:PARams
[:SENSE]:CEVM:ULINK:PROfile:USER{1:50}:PUCCh:DMRS:PWRBoost
[:SENSE]:CEVM:ULINK:PROfile:USER{1:50}:PUCCh:DMRS:PWRBoost:COUple
[:SENSE]:CEVM:ULINK:PROfile:USER{1:50}:PUCCh:FORMat
[:SENSE]:CEVM:ULINK:PROfile:USER{1:50}:PUCCh:FORMat:COUple
[:SENSE]:CEVM:ULINK:PROfile:USER{1:50}:PUCCh:N:ONE
[:SENSE]:CEVM:ULINK:PROfile:USER{1:50}:PUCCh:N:ONE:COUple
[:SENSE]:CEVM:ULINK:PROfile:USER{1:50}:PUCCh:N:TWO
[:SENSE]:CEVM:ULINK:PROfile:USER{1:50}:PUCCh:NCS:ONE
[:SENSE]:CEVM:ULINK:PROfile:USER{1:50}:PUCCh:NRB:TWO
[:SENSE]:CEVM:ULINK:PROfile:USER{1:50}:PUCCh:OS

```

LTE-TDD Programming Commands
CEVM

[:SENSE] : CEVM : ULINK : PROFILE : USER { 1 : 50 } : PUCCh : OS : COUPle
[:SENSE] : CEVM : ULINK : PROFILE : USER { 1 : 50 } : PUCCh : PWRBoost
[:SENSE] : CEVM : ULINK : PROFILE : USER { 1 : 50 } : PUCCh : PWRBoost : COUPle
[:SENSE] : CEVM : ULINK : PROFILE : USER { 1 : 50 } : PUCCh : RB
[:SENSE] : CEVM : ULINK : PROFILE : USER { 1 : 50 } : PUCCh : RB : COUPle
[:SENSE] : CEVM : ULINK : PROFILE : USER { 1 : 50 } : PUCCh : SHIFt
[:SENSE] : CEVM : ULINK : PROFILE : USER { 1 : 50 } : PUCCh : SLOT { 0 : 19 } : CSHift
[:SENSE] : CEVM : ULINK : PROFILE : USER { 1 : 50 } : PUCCh : SLOT { 0 : 19 } : DELete/nquery/
[:SENSE] : CEVM : ULINK : PROFILE : USER { 1 : 50 } : PUCCh : SLOT { 0 : 19 } : DMRS : GROUp
[:SENSE] : CEVM : ULINK : PROFILE : USER { 1 : 50 } : PUCCh : SLOT { 0 : 19 } : DMRS : PWRBoost
[:SENSE] : CEVM : ULINK : PROFILE : USER { 1 : 50 } : PUCCh : SLOT { 0 : 19 } : FORMat
[:SENSE] : CEVM : ULINK : PROFILE : USER { 1 : 50 } : PUCCh : SLOT { 0 : 19 } : N : ONE
[:SENSE] : CEVM : ULINK : PROFILE : USER { 1 : 50 } : PUCCh : SLOT { 0 : 19 } : OS
[:SENSE] : CEVM : ULINK : PROFILE : USER { 1 : 50 } : PUCCh : SLOT { 0 : 19 } : POSItion?/qonly/
[:SENSE] : CEVM : ULINK : PROFILE : USER { 1 : 50 } : PUCCh : SLOT { 0 : 19 } : PWRBoost
[:SENSE] : CEVM : ULINK : PROFILE : USER { 1 : 50 } : PUCCh : SLOT { 0 : 19 } : RB
[:SENSE] : CEVM : ULINK : PROFILE : USER { 1 : 50 } : PUCCh : SSLot
[:SENSE] : CEVM : ULINK : PROFILE : USER { 1 : 50 } : PUCCh : SSLot : AUTO
[:SENSE] : CEVM : ULINK : PROFILE : USER { 1 : 50 } : PUSCh
[:SENSE] : CEVM : ULINK : PROFILE : USER { 1 : 50 } : PUSCh : ACTive
[:SENSE] : CEVM : ULINK : PROFILE : USER { 1 : 50 } : PUSCh : ADD : SLOT/nquery/
[:SENSE] : CEVM : ULINK : PROFILE : USER { 1 : 50 } : PUSCh : COUNT?/qonly/
[:SENSE] : CEVM : ULINK : PROFILE : USER { 1 : 50 } : PUSCh : CTNB
[:SENSE] : CEVM : ULINK : PROFILE : USER { 1 : 50 } : PUSCh : CTNB : COUPle
[:SENSE] : CEVM : ULINK : PROFILE : USER { 1 : 50 } : PUSCh : DMRS
[:SENSE] : CEVM : ULINK : PROFILE : USER { 1 : 50 } : PUSCh : DMRS : CSHift
[:SENSE] : CEVM : ULINK : PROFILE : USER { 1 : 50 } : PUSCh : DMRS : CSHift : COUPle
[:SENSE] : CEVM : ULINK : PROFILE : USER { 1 : 50 } : PUSCh : DMRS : GROUp
[:SENSE] : CEVM : ULINK : PROFILE : USER { 1 : 50 } : PUSCh : DMRS : GROUp : COUPle
[:SENSE] : CEVM : ULINK : PROFILE : USER { 1 : 50 } : PUSCh : DMRS : ONE
[:SENSE] : CEVM : ULINK : PROFILE : USER { 1 : 50 } : PUSCh : DMRS : PARAmS
[:SENSE] : CEVM : ULINK : PROFILE : USER { 1 : 50 } : PUSCh : DMRS : PWRBoost
[:SENSE] : CEVM : ULINK : PROFILE : USER { 1 : 50 } : PUSCh : DMRS : PWRBoost : COUPle
[:SENSE] : CEVM : ULINK : PROFILE : USER { 1 : 50 } : PUSCh : DMRS : SEQuence
[:SENSE] : CEVM : ULINK : PROFILE : USER { 1 : 50 } : PUSCh : DMRS : SEQuence : COUPle
[:SENSE] : CEVM : ULINK : PROFILE : USER { 1 : 50 } : PUSCh : DMRS : TWO
[:SENSE] : CEVM : ULINK : PROFILE : USER { 1 : 50 } : PUSCh : DSS
[:SENSE] : CEVM : ULINK : PROFILE : USER { 1 : 50 } : PUSCh : FHOPping
[:SENSE] : CEVM : ULINK : PROFILE : USER { 1 : 50 } : PUSCh : MODulation : TYPE
[:SENSE] : CEVM : ULINK : PROFILE : USER { 1 : 50 } : PUSCh : MODulation : TYPE : COUPle
[:SENSE] : CEVM : ULINK : PROFILE : USER { 1 : 50 } : PUSCh : NRBHo
[:SENSE] : CEVM : ULINK : PROFILE : USER { 1 : 50 } : PUSCh : NSB
[:SENSE] : CEVM : ULINK : PROFILE : USER { 1 : 50 } : PUSCh : PWRBoost
[:SENSE] : CEVM : ULINK : PROFILE : USER { 1 : 50 } : PUSCh : PWRBoost : COUPle
[:SENSE] : CEVM : ULINK : PROFILE : USER { 1 : 50 } : PUSCh : RB : END
[:SENSE] : CEVM : ULINK : PROFILE : USER { 1 : 50 } : PUSCh : RB : END : COUPle
[:SENSE] : CEVM : ULINK : PROFILE : USER { 1 : 50 } : PUSCh : RB : START
[:SENSE] : CEVM : ULINK : PROFILE : USER { 1 : 50 } : PUSCh : RB : START : COUPle
[:SENSE] : CEVM : ULINK : PROFILE : USER { 1 : 50 } : PUSCh : SLOT { 0 : 19 } : CTNB

```

[:SENSE]:CEVM:ULINK:PROFile:USER{1:50}:PUSCh:SLOT{0:19}:DELeTe/nquery/
[:SENSE]:CEVM:ULINK:PROFile:USER{1:50}:PUSCh:SLOT{0:19}:DMRS:CSHift
[:SENSE]:CEVM:ULINK:PROFile:USER{1:50}:PUSCh:SLOT{0:19}:DMRS:GRoup
[:SENSE]:CEVM:ULINK:PROFile:USER{1:50}:PUSCh:SLOT{0:19}:DMRS:PWRBoost
[:SENSE]:CEVM:ULINK:PROFile:USER{1:50}:PUSCh:SLOT{0:19}:DMRS:SEQuence
[:SENSE]:CEVM:ULINK:PROFile:USER{1:50}:PUSCh:SLOT{0:19}:MODulation:TYPE
[:SENSE]:CEVM:ULINK:PROFile:USER{1:50}:PUSCh:SLOT{0:19}:POSition?/qonly/
[:SENSE]:CEVM:ULINK:PROFile:USER{1:50}:PUSCh:SLOT{0:19}:PWRBoost
[:SENSE]:CEVM:ULINK:PROFile:USER{1:50}:PUSCh:SLOT{0:19}:RB:END
[:SENSE]:CEVM:ULINK:PROFile:USER{1:50}:PUSCh:SLOT{0:19}:RB:START
[:SENSE]:CEVM:ULINK:PROFile:USER{1:50}:PUSCh:SSLot
[:SENSE]:CEVM:ULINK:PROFile:USER{1:50}:PUSCh:SSLot:AUTO
[:SENSE]:CEVM:ULINK:PROFile:USER{1:50}:RNTI
[:SENSE]:CEVM:ULINK:PROFile:USER{1:50}:SFNumber
[:SENSE]:CEVM:ULINK:PROFile:USER{1:50}:SRS
[:SENSE]:CEVM:ULINK:PROFile:USER{1:50}:SRS:ACTive
[:SENSE]:CEVM:ULINK:PROFile:USER{1:50}:SRS:BCONfig
[:SENSE]:CEVM:ULINK:PROFile:USER{1:50}:SRS:BWIDth
[:SENSE]:CEVM:ULINK:PROFile:USER{1:50}:SRS:CINdex
[:SENSE]:CEVM:ULINK:PROFile:USER{1:50}:SRS:CSHift
[:SENSE]:CEVM:ULINK:PROFile:USER{1:50}:SRS:FDPosition
[:SENSE]:CEVM:ULINK:PROFile:USER{1:50}:SRS:HBWidth
[:SENSE]:CEVM:ULINK:PROFile:USER{1:50}:SRS:PWRBoost
[:SENSE]:CEVM:ULINK:PROFile:USER{1:50}:SRS:SFConfig
[:SENSE]:CEVM:ULINK:PROFile:USER{1:50}:SRS:SSLot
[:SENSE]:CEVM:ULINK:PROFile:USER{1:50}:SRS:SSLot:AUTO
[:SENSE]:CEVM:ULINK:PROFile:USER{1:50}:SRS:TCOMb
[:SENSE]:CEVM:ULINK:SYNC:CPLength
[:SENSE]:CEVM:ULINK:SYNC:HSSHift
[:SENSE]:CEVM:ULINK:SYNC:PDSwap
[:SENSE]:CEVM:ULINK:SYNC:TYPE
[:SENSE]:WINDow:LENGth
[:SENSE]:WINDow:LENGth:CUSTom
[:SENSE]:CEVM:DLINK:DECode
[:SENSE]:CEVM:DLINK:DECode:DFINclude
[:SENSE]:CEVM:DLINK:DECode:RNTI:MAXimum:RA
[:SENSE]:CEVM:DLINK:DECode:RNTI:MAXimum:TPC
[:SENSE]:CEVM:DLINK:DECode:RNTI:MINimum:RA
[:SENSE]:CEVM:DLINK:DECode:RNTI:MINimum:TPC
[:SENSE]:CEVM:DLINK:PDSCh:CSRatio
[:SENSE]:CEVM:DLINK:PROFile:ADD:USER
[:SENSE]:CEVM:DLINK:PROFile:AUTO[:DETect]:CCPower
[:SENSE]:CEVM:DLINK:PROFile:AUTO[:DETect]:MODE
[:SENSE]:CEVM:DLINK:PROFile:AUTO[:DETect]:POWER
[:SENSE]:CEVM:DLINK:PROFile:AUTO[:DETect]:POWER:PMODE
[:SENSE]:CEVM:DLINK:PROFile:AUTO[:DETect]:POWER:ROUND
[:SENSE]:CEVM:DLINK:PROFile:AUTO:PDSCh:CBIndex
[:SENSE]:CEVM:DLINK:PROFile:AUTO:PDSCh:CDD
[:SENSE]:CEVM:DLINK:PROFile:AUTO:PDSCh:NCODewords

```

LTE-TDD Programming Commands
CEVM

[:SENSE] : CEVM : DLINK : PROFILE : AUTO : PDSCH : NLAYERS
[:SENSE] : CEVM : DLINK : PROFILE : AUTO : PDSCH : PRECODING
[:SENSE] : CEVM : DLINK : PROFILE : AUTO : PDSCH : QAM16 : CWONE : ENABLE
[:SENSE] : CEVM : DLINK : PROFILE : AUTO : PDSCH : QAM16 : CWONE : PWRBOOST
[:SENSE] : CEVM : DLINK : PROFILE : AUTO : PDSCH : QAM16 : CWZERO : ENABLE
[:SENSE] : CEVM : DLINK : PROFILE : AUTO : PDSCH : QAM16 : EPRE
[:SENSE] : CEVM : DLINK : PROFILE : AUTO : PDSCH : QAM16 : PWRBOOST
[:SENSE] : CEVM : DLINK : PROFILE : AUTO : PDSCH : QAM64 : CWONE : ENABLE
[:SENSE] : CEVM : DLINK : PROFILE : AUTO : PDSCH : QAM64 : CWONE : PWRBOOST
[:SENSE] : CEVM : DLINK : PROFILE : AUTO : PDSCH : QAM64 : CWZERO : ENABLE
[:SENSE] : CEVM : DLINK : PROFILE : AUTO : PDSCH : QAM64 : EPRE
[:SENSE] : CEVM : DLINK : PROFILE : AUTO : PDSCH : QAM64 : PWRBOOST
[:SENSE] : CEVM : DLINK : PROFILE : AUTO : PDSCH : QPSK : CWONE : ENABLE
[:SENSE] : CEVM : DLINK : PROFILE : AUTO : PDSCH : QPSK : CWONE : PWRBOOST
[:SENSE] : CEVM : DLINK : PROFILE : AUTO : PDSCH : QPSK : CWZERO : ENABLE
[:SENSE] : CEVM : DLINK : PROFILE : AUTO : PDSCH : QPSK : EPRE
[:SENSE] : CEVM : DLINK : PROFILE : AUTO : PDSCH : QPSK : PWRBOOST
[:SENSE] : CEVM : DLINK : PROFILE : AUTO : PMCH : PWRBOOST
[:SENSE] : CEVM : DLINK : PROFILE : CLEAR
[:SENSE] : CEVM : DLINK : PROFILE : COUNT ?
[:SENSE] : CEVM : DLINK : PROFILE : EPRE : PANTENNA
[:SENSE] : CEVM : DLINK : PROFILE : EUSERS : COUNT
[:SENSE] : CEVM : DLINK : PROFILE : EXCLUDE : ALL
[:SENSE] : CEVM : DLINK : PROFILE : INCLUDE : ALL
[:SENSE] : CEVM : DLINK : PROFILE : MBSFN
[:SENSE] : CEVM : DLINK : PROFILE : MBSFN : ACTIVE
[:SENSE] : CEVM : DLINK : PROFILE : MBSFN : AID
[:SENSE] : CEVM : DLINK : PROFILE : MBSFN : NMRLLENGTH
[:SENSE] : CEVM : DLINK : PROFILE : MBSFN : PWRBOOST
[:SENSE] : CEVM : DLINK : PROFILE : MBSFN : SUBFRAME { 1 : 9 } : ACTIVE
[:SENSE] : CEVM : DLINK : PROFILE : PBCH
[:SENSE] : CEVM : DLINK : PROFILE : PBCH : PWRBOOST
[:SENSE] : CEVM : DLINK : PROFILE : PCFICH
[:SENSE] : CEVM : DLINK : PROFILE : PCFICH : PWRBOOST
[:SENSE] : CEVM : DLINK : PROFILE : PDCCH
[:SENSE] : CEVM : DLINK : PROFILE : PDCCH : ALLOCATION : AUTO [: DETECT]
[:SENSE] : CEVM : DLINK : PROFILE : PDCCH : ALLOCATION : CONSTANT
[:SENSE] : CEVM : DLINK : PROFILE : PDCCH : ALLOCATION : SUBFRAME { 0 : 9 } : SYMBOLS
[:SENSE] : CEVM : DLINK : PROFILE : PDCCH : PWRBOOST
[:SENSE] : CEVM : DLINK : PROFILE : PDCCH : PWRBOOST : STEP
[:SENSE] : CEVM : DLINK : PROFILE : PHICH
[:SENSE] : CEVM : DLINK : PROFILE : PHICH : ALLOCATION : RATIO
[:SENSE] : CEVM : DLINK : PROFILE : PHICH : DESPREAD
[:SENSE] : CEVM : DLINK : PROFILE : PHICH : DURATION
[:SENSE] : CEVM : DLINK : PROFILE : PHICH : MIDEFINITION
[:SENSE] : CEVM : DLINK : PROFILE : PHICH : PWRBOOST
[:SENSE] : CEVM : DLINK : PROFILE : PHICH : PWRBOOST : STEP
[:SENSE] : CEVM : DLINK : PROFILE : PMCH
[:SENSE] : CEVM : DLINK : PROFILE : PMCH : SUBFRAME { 1 : 9 } : ACTIVE

```

[:SENSE]:CEVM:DLINK:PROFile:PMCH:SUBFrame{1:9}:MODulation:TYPE
[:SENSE]:CEVM:DLINK:PROFile:PMCH:SUBFrame{1:9}:PWRBoost
[:SENSE]:CEVM:DLINK:PROFile:PRS
[:SENSE]:CEVM:DLINK:PROFile:PRS:ACTive
[:SENSE]:CEVM:DLINK:PROFile:PRS:BANDwidth
[:SENSE]:CEVM:DLINK:PROFile:PRS:INDex
[:SENSE]:CEVM:DLINK:PROFile:PRS:PWRBoost
[:SENSE]:CEVM:DLINK:PROFile:PRS:SUBFrame:NUMBer
[:SENSE]:CEVM:DLINK:PROFile:PSS
[:SENSE]:CEVM:DLINK:PROFile:PSS:PWRBoost
[:SENSE]:CEVM:DLINK:PROFile:QAM16:RNTI
[:SENSE]:CEVM:DLINK:PROFile:QAM16:UERS:ACTive
[:SENSE]:CEVM:DLINK:PROFile:QAM16:UERS:PORT
[:SENSE]:CEVM:DLINK:PROFile:QAM16:UERS:PWRBoost
[:SENSE]:CEVM:DLINK:PROFile:QAM16:UERS:SCID
[:SENSE]:CEVM:DLINK:PROFile:QAM64:RNTI
[:SENSE]:CEVM:DLINK:PROFile:QAM64:UERS:ACTive
[:SENSE]:CEVM:DLINK:PROFile:QAM64:UERS:PORT
[:SENSE]:CEVM:DLINK:PROFile:QAM64:UERS:PWRBoost
[:SENSE]:CEVM:DLINK:PROFile:QAM64:UERS:SCID
[:SENSE]:CEVM:DLINK:PROFile:QPSK [:SENSE]:CEVM:DLINK:PROFile:QPSK:RNTI
[:SENSE]:CEVM:DLINK:PROFile:QPSK:UERS:ACTive
[:SENSE]:CEVM:DLINK:PROFile:QPSK:UERS:PORT
[:SENSE]:CEVM:DLINK:PROFile:QPSK:UERS:PWRBoost
[:SENSE]:CEVM:DLINK:PROFile:QPSK:UERS:SCID
[:SENSE]:CEVM:DLINK:PROFile:RS
[:SENSE]:CEVM:DLINK:PROFile:RS:PWRBoost
[:SENSE]:CEVM:DLINK:PROFile:SSS
[:SENSE]:CEVM:DLINK:PROFile:SSS:PWRBoost
[:SENSE]:CEVM:DLINK:PROFile:USER{1:50}:DECoded:PDSCh
[:SENSE]:CEVM:DLINK:PROFile:USER{1:50}:DECoded:PDSCh:CWONE:ENABLE
[:SENSE]:CEVM:DLINK:PROFile:USER{1:50}:DECoded:PDSCh:CWONE:PWRBoost
[:SENSE]:CEVM:DLINK:PROFile:USER{1:50}:DECoded:PDSCh:CWZero:ENABLE
[:SENSE]:CEVM:DLINK:PROFile:USER{1:50}:DECoded:PDSCh:CWZero:PWRBoost
[:SENSE]:CEVM:DLINK:PROFile:USER{1:50}:DECoded:PDSCh:EPRE
[:SENSE]:CEVM:DLINK:PROFile:USER{1:50}:DELete
[:SENSE]:CEVM:DLINK:PROFile:USER{1:50}:PDSCh:ADD:ALLocation
[:SENSE]:CEVM:DLINK:PROFile:USER{1:50}:PDSCh:ALLocation{1:50}:CWONE:
MODulation

[:SENSE]:CEVM:DLINK:PROFile:USER{1:50}:PDSCh:ALLocation{1:50}:RB
[:SENSE]:CEVM:DLINK:PROFile:USER{1:50}:PDSCh:ALLocation{1:50}:SLOT
[:SENSE]:CEVM:DLINK:PROFile:USER{1:50}:PDSCh:CBINDEX
[:SENSE]:CEVM:DLINK:PROFile:USER{1:50}:PDSCh:CDD
[:SENSE]:CEVM:DLINK:PROFile:USER{1:50}:PDSCh:COUNT?
[:SENSE]:CEVM:DLINK:PROFile:USER{1:50}:PDSCh:CWONE
[:SENSE]:CEVM:DLINK:PROFile:USER{1:50}:PDSCh:CWONE:ENABLE
[:SENSE]:CEVM:DLINK:PROFile:USER{1:50}:PDSCh:CWONE:MODulation
[:SENSE]:CEVM:DLINK:PROFile:USER{1:50}:PDSCh:CWONE:MODulation:TYPE

```

LTE-TDD Programming Commands
CEVM

[:SENSE] : CEVM : DLINK : PROFILE : USER { 1 : 50 } : PDSCH : CWONE : MODULATION : TYPE : COUPLE
[:SENSE] : CEVM : DLINK : PROFILE : USER { 1 : 50 } : PDSCH : CWONE : PWRBOOST
[:SENSE] : CEVM : DLINK : PROFILE : USER { 1 : 50 } : PDSCH : CWONE : PWRBOOST : COUPLE
[:SENSE] : CEVM : DLINK : PROFILE : USER { 1 : 50 } : PDSCH : CWZERO
[:SENSE] : CEVM : DLINK : PROFILE : USER { 1 : 50 } : PDSCH : CWZERO : ENABLE
[:SENSE] : CEVM : DLINK : PROFILE : USER { 1 : 50 } : PDSCH : EPRE
[:SENSE] : CEVM : DLINK : PROFILE : USER { 1 : 50 } : PDSCH : EPRE : COUPLE
[:SENSE] : CEVM : DLINK : PROFILE : USER { 1 : 50 } : PDSCH : FINDEX
[:SENSE] : CEVM : DLINK : PROFILE : USER { 1 : 50 } : PDSCH : FINDEX : COUPLE
[:SENSE] : CEVM : DLINK : PROFILE : USER { 1 : 50 } : PDSCH : MODULATION
[:SENSE] : CEVM : DLINK : PROFILE : USER { 1 : 50 } : PDSCH : MODULATION : TYPE
[:SENSE] : CEVM : DLINK : PROFILE : USER { 1 : 50 } : PDSCH : MODULATION : TYPE : COUPLE
[:SENSE] : CEVM : DLINK : PROFILE : USER { 1 : 50 } : PDSCH : NCODWORDS
[:SENSE] : CEVM : DLINK : PROFILE : USER { 1 : 50 } : PDSCH : NLAYERS
[:SENSE] : CEVM : DLINK : PROFILE : USER { 1 : 50 } : PDSCH : PRECODING
[:SENSE] : CEVM : DLINK : PROFILE : USER { 1 : 50 } : PDSCH : PWRBOOST
[:SENSE] : CEVM : DLINK : PROFILE : USER { 1 : 50 } : PDSCH : PWRBOOST : COUPLE
[:SENSE] : CEVM : DLINK : PROFILE : USER { 1 : 50 } : PDSCH : RBALLOC { 1 : 250 }
[:SENSE] : CEVM : DLINK : PROFILE : USER { 1 : 50 } : PDSCH : RBALLOC { 1 : 250 } : CWONE
[:SENSE] : CEVM : DLINK : PROFILE : USER { 1 : 50 } : PDSCH : RBALLOC { 1 : 250 } : CWONE : MODULATION
[:SENSE] : CEVM : DLINK : PROFILE : USER { 1 : 50 } : PDSCH : RBALLOC { 1 : 250 } : CWONE :
MODULATION : TYPE

[:SENSE] : CEVM : DLINK : PROFILE : USER { 1 : 50 } : PDSCH : RBALLOC { 1 : 250 } : CWONE : PWRBOOST
[:SENSE] : CEVM : DLINK : PROFILE : USER { 1 : 50 } : PDSCH : RBALLOC { 1 : 250 } : DELETE
[:SENSE] : CEVM : DLINK : PROFILE : USER { 1 : 50 } : PDSCH : RBALLOC { 1 : 250 } : EPRE
[:SENSE] : CEVM : DLINK : PROFILE : USER { 1 : 50 } : PDSCH : RBALLOC { 1 : 250 } : FINDEX
[:SENSE] : CEVM : DLINK : PROFILE : USER { 1 : 50 } : PDSCH : RBALLOC { 1 : 250 } : MODULATION
[:SENSE] : CEVM : DLINK : PROFILE : USER { 1 : 50 } : PDSCH : RBALLOC { 1 : 250 } : MODULATION : TYPE
[:SENSE] : CEVM : DLINK : PROFILE : USER { 1 : 50 } : PDSCH : RBALLOC { 1 : 250 } : PWRBOOST
[:SENSE] : CEVM : DLINK : PROFILE : USER { 1 : 50 } : PDSCH : RBALLOC { 1 : 250 } : RB
[:SENSE] : CEVM : DLINK : PROFILE : USER { 1 : 50 } : PDSCH : RBALLOC { 1 : 250 } : RB : END
[:SENSE] : CEVM : DLINK : PROFILE : USER { 1 : 50 } : PDSCH : RBALLOC { 1 : 250 } : RB : START
[:SENSE] : CEVM : DLINK : PROFILE : USER { 1 : 50 } : PDSCH : RBALLOC { 1 : 250 } : SLOT
[:SENSE] : CEVM : DLINK : PROFILE : USER { 1 : 50 } : PDSCH : RBALLOC { 1 : 250 } : SLOT : END
[:SENSE] : CEVM : DLINK : PROFILE : USER { 1 : 50 } : PDSCH : RBALLOC { 1 : 250 } : SLOT : START
[:SENSE] : CEVM : DLINK : PROFILE : USER { 1 : 50 } : RNTI
[:SENSE] : CEVM : DLINK : PROFILE : USER { 1 : 50 } : UERS
[:SENSE] : CEVM : DLINK : PROFILE : USER { 1 : 50 } : UERS : ACTIVE
[:SENSE] : CEVM : DLINK : PROFILE : USER { 1 : 50 } : UERS : PORT
[:SENSE] : CEVM : DLINK : PROFILE : USER { 1 : 50 } : UERS : PWRBOOST
[:SENSE] : CEVM : DLINK : PROFILE : USER { 1 : 50 } : UERS : SCID
[:SENSE] : CEVM : DLINK : RESULT
[:SENSE] : CEVM : DLINK : RESULT : ALL
[:SENSE] : CEVM : DLINK : SYNC
[:SENSE] : CEVM : DLINK : SYNC : ANTENNA
[:SENSE] : CEVM : DLINK : SYNC : ANTENNA : DETECT
[:SENSE] : CEVM : DLINK : SYNC : ANTENNA : DETECT : THRESHOLD
[:SENSE] : CEVM : DLINK : SYNC : ANTENNA : INACTIVE

[:SENSE] : CEVM : DLINK : SYNC : ANTenna : INACTIVE : PATHS
[:SENSE] : CEVM : DLINK : SYNC : ANTenna : NUMBER
[:SENSE] : CEVM : DLINK : SYNC : ANTenna : PORT
[:SENSE] : CEVM : DLINK : SYNC : ANTenna : PORT : AUTO
[:SENSE] : CEVM : DLINK : SYNC : CID
[:SENSE] : CEVM : DLINK : SYNC : CID : AUTO
[:SENSE] : CEVM : DLINK : SYNC : CPLength
[:SENSE] : CEVM : DLINK : SYNC : MIMO
[:SENSE] : CEVM : DLINK : SYNC : MIMO : DECODING
[:SENSE] : CEVM : DLINK : SYNC : RSPRS
[:SENSE] : CEVM : DLINK : SYNC : SS
[:SENSE] : CEVM : DLINK : SYNC : SS : ANTenna
[:SENSE] : CEVM : DLINK : SYNC : SS : ANTenna : PORT
[:SENSE] : CEVM : DLINK : SYNC : TYPE
[:SENSE] : CEVM : DLINK : UERS
[:SENSE] : CEVM : DLINK : UERS : CFRCompen

LTE-TDD Programming Commands
CEVM

CEVM results (general)

Index	Result Parameter
0	Overall Pass/Fail Result 0:Pass, 1:Fail, -1:Not tested
1	EVM (%rms)
2	EVM Sym Time Adjust
3	EVM Pk (%)
4	EVM Pk Index
5	EVM Peak Sub Car Index
6	Data EVM (%rms) – Not available when Detection is Manual and no User is added.
7	3GPP-defined QPSK EVM (%rms)
8	3GPP-defined 16QAM EVM (%rms)
9	3GPP-defined 64QAM EVM (%rms)
10	RS EVM (%rms)
11	RS Tx. Power (dBm)
12	OFDM Sym. Tx. Power (dBm)
13	Freq Error (Hz)
14	Sync Corr (%)
15	Sync Type
16	Common Tracking Error (%rms)
17	Symbol Clock Error (ppm)
18	Time Offset(s)
19	IQ Offset (dB)
20	IQ Gain Imbalance (dB)
21	IQ Quad Error (deg)
22	IQ Timing Skew (s)
23	CP Length Mode
24	Cell ID
25	Cell ID Group/Sector
26	RS-OS/PRS
27	Reference Signal Rx Power (Avg)

Index	Result Parameter
28	Reference Signal Rx Quality
29	Magnitude Error (%)
30	Phase Error (radians)

CEVM results (Spectrum Flatness Equalizer Channel Frequency)

These results are part of LTE TDD CEVM measurement, and they can be queried by
`:MEAS|:READ|:FETCh:LSEQuencer:ACQuire{1:512}:ASTep{1:1000}:SFLatness[:ECFRequency]?`

Index	Result Parameter
0	Results Length - The total length of the results (includes the length field itself), currently fixed to 610
1	RP 1 Pass/Fail Result - 0:Pass, 1:Fail, -1:Not tested
2	RP 1 Value - maximum Ripple in Range 1
3	RP 2 Pass/Fail Result - 0:Pass, 1:Fail, -1:Not tested
4	RP 2 Value - maximum Ripple in Range 2
5	RP 12 Pass/Fail Result - 0:Pass, 1:Fail, -1:Not tested
6	RP 12 Value - the maximum ripple between the upper side of Range 1 and lower side of Range 2
7	RP 21 Pass/Fail Result - 0:Pass, 1:Fail, -1:Not tested
8	RP 21 Value - the maximum ripple between the upper side of Range 2 and lower side of Range 1
9	Number of subcarriers
10 - 609	600 Equalizer Coefficients - EC(f). Only the first Num_Of_SubCarriers values are valid

CEVM results (Spectrum Flatness Ripple)

These results are part of LTE TDD CEVM measurement, and they can be queried by
`:MEAS|:READ|:FETCh:LSEQuencer:ACQuire{1:512}:ASTep{1:1000}:SFLatness:RIPPLe?`

Index	Result Parameter
0	Results Length - The total length of the results (includes the length field itself), currently fixed to 9
1	RP 1 Value - maximum Ripple in Range 1
2	RP 2 Value - maximum Ripple in Range 2

Index	Result Parameter
3	RP 12 Value - the maximum ripple between the upper side of Range 1 and lower side of Range 2
4	RP 21 Value - the maximum ripple between the upper side of Range 2 and lower side of Range 1
5	Min Ec(f)1 - the minimum EC(f) in Range 1
6	Max Ec(f)1 - the maximum EC(f) in Range 1
7	Min Ec(f)2 - the minimum EC(f) in Range 2
8	Max Ec(f)2 - the maximum EC(f) in Range 2

CEVM results (Inband Emission Power)

These results are part of LTE TDD CEVM measurement, and they can be queried by
:MEAS|:READ|:FETCh:LSEQuencer:ACQuire{1:512}:ASTep{1:1000}:IEMission[:POWer]?

Index	Result Parameter
0	Results Length - The total length of the results (includes the length field itself), currently fixed to 53
1	Average Power of Active RBs - the average abosulted power of allocated RBs in dBm
2	Number of RBs - the number of RBs in current configuration
3 - 52	Power Per RB - the abosulted power (dBm) per RB. Only the first Number_OF_RB values are valid.

CEVM Results (Inband Emission Margin)

These results are part of LTE TDD CEVM measurement, and they can be queried by
:MEAS|:READ|:FETCh:LSEQuencer:ACQuire{1:512}:ASTep{1:1000}:IEMission:MARGIN?

Index	Result Parameter
0	Results Length - The total length of the results (includes the length field itself), currently fixed to 54
1	Minimal Inband Margin - Inband margin is the difference between the inband emission limit mask and actual measured power per non-allocated RB. The margin = (Limit - Power) in dB. A negative margin indicates that the power exceeds the limit.
2	Minimal Inband Margin Index - the RB index of minimal margin results (ZERO based)
3	Number of RBs - the number of RBs in current configuration
4 - 53	Inband Margin per RB - The Margin result of each RB. (only the first Num_of_RB values are valid). If the RB is active (allocated), the inband margin result will be set to NAN.

CEVM results (Detected Slot Number)

These results are part of LTE TDD CEVM measurement, and they can be queried by
:MEAS|:READ|:FETCh:LSEQuencer:ACQuire{1:512}:ASTep{1:1000}:SLOT[:DETECT]?

There is only one value returned, which represents the actually detected slot number of LTE Modulation Accuracy.

CEVM results (Timing Offset Per Antenna)

These results are part of LTE TDD CEVM measurement, and they can be queried by
:MEAS|:READ|:FETCh:LSEQuencer:ACQuire{1:512}:ASTep{1:1000}:TOPA?

The number of elements in this result varies with the number of C-RS ports and Number of input channels(Rx). For example, if the number of C-RS ports is 4, and the number of input channels is 2, the result contains 8 elements. Each element in the result means the average timing error of the cell-specific reference signal for a C-RS Cell-specific RS/Rx path.

Index	Result Parameter
0~M*N-1	The average timing error of the cell-specific reference signal for M*N C-RS Cell-specific RS/Rx path.

17 TD-SCDMA Programming Commands

This chapter lists all the commands used to set up the TD-SCDMA measurements from within the List Sequencer.

NOTE See also: mode parameters related to TD-SCDMA, as described in **“Mode and Measurement Parameters”** on page 52.

The chapter topics are:

- **Power vs. Time (PvT)**
- **Adjacent Channel Power (ACP)**
- **Spectrum Emissions Mask (SEM)**
- **Occupied Bandwidth (OBW)**
- **Modulation Accuracy (Rho)**
- **QPSK EVM**
- **Code Domain Power (CDP)**
- **Loopback Bit Error Rate (BER)**

Power vs. Time (PvT)

This section provides the remote control SCPI commands for the TD-SCDMA Power vs. Time (PvT) measurement from within the List Sequencer. This measurement is available only if you have the TD-SCDMA measurement application licensed on the test set.

For more detailed information about the PvT measurement, refer to the online help associated with the TD-SCDMA measurement application, which is also available in PDF format (“User’s and Programmer’s Reference”) on the Keysight website, . www.keysight.com/find/e6650a

You can also refer to the measurement guide for the X-series TD-SCDMA measurement application, which is available on the Keysight website, www.keysight.com/find/mxa.

Power vs. Time (PvT) measurement SCPI commands

There is a set of SCPI commands available to program the TD-SCDMA PvT measurement when it is used in the TD-SCDMA mode. To set up the TD-SCDMA measurements from within the Sequence Analyzer mode you need to prefix the SCPI commands with `LSEQuencer:TDSCdma`. For example, the `[:SENSe] :PVTime` part of the TD-SCDMA PvT SCPI commands are replaced with `[:SENSe] :LSEQuencer:TDSCdma:PVTime`.

The following commands are used to set up the TD-SCDMA PvT measurement.

```
[ :SENSe ] :LSEQuencer:TDSCdma:PVTime:SWEep:TIME <integer>
[ :SENSe ] :LSEQuencer:TDSCdma:PVTime:SWEep:TIME?
[ :SENSe ] :LSEQuencer:TDSCdma:PVTime:MASK:SELEct CUSTom|STANdard
[ :SENSe ] :LSEQuencer:TDSCdma:PVTime:MASK:SELEct?
[ :SENSe ] :LSEQuencer:TDSCdma:PVTime:MASK:LIST:LOWer:ABSolute <ampl>, <ampl>,
<ampl>, <ampl>
[ :SENSe ] :LSEQuencer:TDSCdma:PVTime:MASK:LIST:LOWer:ABSolute?
[ :SENSe ] :LSEQuencer:TDSCdma:PVTime:MASK:LIST:LOWer:POINts?
[ :SENSe ] :LSEQuencer:TDSCdma:PVTime:MASK:LIST:LOWer:RELative <ampl>, <ampl>,
<ampl>, <ampl>
[ :SENSe ] :LSEQuencer:TDSCdma:PVTime:MASK:LIST:LOWer:RELative?
[ :SENSe ] :LSEQuencer:TDSCdma:PVTime:MASK:LIST:LOWer:TIME <time>, <time>,
<time>, <time>
[ :SENSe ] :LSEQuencer:TDSCdma:PVTime:MASK:LIST:LOWer:TIME?
[ :SENSe ] :LSEQuencer:TDSCdma:PVTime:MASK:LIST:UPPer:ABSolute <ampl>, <ampl>,
<ampl>, <ampl>
[ :SENSe ] :LSEQuencer:TDSCdma:PVTime:MASK:LIST:UPPer:ABSolute?
[ :SENSe ] :LSEQuencer:TDSCdma:PVTime:MASK:LIST:UPPer:POINts?
[ :SENSe ] :LSEQuencer:TDSCdma:PVTime:MASK:LIST:UPPer:RELative <ampl>, <ampl>,
<ampl>, <ampl>
```



```

[:SENSE]:LSEQuencer:TDSCdma:PVTime:MASK:LIST:UPPer:RELative?
[:SENSE]:LSEQuencer:TDSCdma:PVTime:MASK:LIST:UPPer:TIME <time>, <time>,
<time>, <time>
[:SENSE]:LSEQuencer:TDSCdma:PVTime:MASK:LIST:UPPer:TIME?
[:SENSE]:LSEQuencer:TDSCdma:SLOT TS0|TS1|TS2|TS3|TS4|TS5|TS6|UPTS|DPTS
[:SENSE]:LSEQuencer:TDSCdma:SLOT?
[:SENSE]:LSEQuencer:TDSCdma:RADio:CONFigure:HSDPa[:STATe] 0|1|OFF|ON
[:SENSE]:LSEQuencer:TDSCdma:RADio:CONFigure:HSDPa[:STATe]?
[:SENSE]:LSEQuencer:TDSCdma:TDEMod:SCODE <integer>
[:SENSE]:LSEQuencer:TDSCdma:TDEMod:SCODE?
[:SENSE]:LSEQuencer:TDSCdma:TDEMod:UPTS <integer>
[:SENSE]:LSEQuencer:TDSCdma:TDEMod:UPTS?
[:SENSE]:LSEQuencer:TDSCdma:TDEMod:ULSPoint <integer>
[:SENSE]:LSEQuencer:TDSCdma:TDEMod:ULSPoint?
[:SENSE]:LSEQuencer:TDSCdma:TDEMod:MXUSer:TS0 <integer>
[:SENSE]:LSEQuencer:TDSCdma:TDEMod:MXUSer:TS0?
[:SENSE]:LSEQuencer:TDSCdma:TDEMod:MXUSer:TS1 <integer>
[:SENSE]:LSEQuencer:TDSCdma:TDEMod:MXUSer:TS1?
[:SENSE]:LSEQuencer:TDSCdma:TDEMod:MXUSer:TS2 <integer>
[:SENSE]:LSEQuencer:TDSCdma:TDEMod:MXUSer:TS2?
[:SENSE]:LSEQuencer:TDSCdma:TDEMod:MXUSer:TS3 <integer>
[:SENSE]:LSEQuencer:TDSCdma:TDEMod:MXUSer:TS3?
[:SENSE]:LSEQuencer:TDSCdma:TDEMod:MXUSer:TS4 <integer>
[:SENSE]:LSEQuencer:TDSCdma:TDEMod:MXUSer:TS4?
[:SENSE]:LSEQuencer:TDSCdma:TDEMod:MXUSer:TS5 <integer>
[:SENSE]:LSEQuencer:TDSCdma:TDEMod:MXUSer:TS5?
[:SENSE]:LSEQuencer:TDSCdma:TDEMod:MXUSer:TS6 <integer>
[:SENSE]:LSEQuencer:TDSCdma:TDEMod:MXUSer:TS6?
[:SENSE]:LSEQuencer:TDSCdma:TDEMod:CDCHannel:DETection AUTO|MAN
[:SENSE]:LSEQuencer:TDSCdma:TDEMod:CDCHannel:DETection?
[:SENSE]:LSEQuencer:TDSCdma:TDEMod:MODScheme:AUTO 1|0|ON|OFF
[:SENSE]:LSEQuencer:TDSCdma:TDEMod:MODScheme:AUTO?

```

TD-SCDMA Programming Commands

Power vs. Time (PvT)

```
[ :SENSE ] :LSEQuencer:TDSCdma:TDEMod:CDCHannel:ACTive
<spread_code_length>,<code_channel>,0|1|OFF|ON

[ :SENSE ] :LSEQuencer:TDSCdma:TDEMod:CDCHannel:ACTive?
<spread_code_length>,<code_channel>

[ :SENSE ] :LSEQuencer:TDSCdma:TDEMod:MSHift
<spread_code_length>,<code_channel>,<integer>

[ :SENSE ] :LSEQuencer:TDSCdma:TDEMod:MSHift?
<spread_code_length>,<code_channel>

[ :SENSE ] :LSEQuencer:TDSCdma:TDEMod:MODFormat
<integer>,<integer>,AUTO|QPSK|PSK8|QAM16|QAM64

[ :SENSE ] :LSEQuencer:TDSCdma:TDEMod:MODFormat? <integer>,<integer>

[ :SENSE ] :LSEQuencer:TDSCdma:TDEMod:PHASe:SHIFt <integer>,<integer>,<real>

[ :SENSE ] :LSEQuencer:TDSCdma:TDEMod:PHASe:SHIFt? <integer>,<integer>

[ :SENSE ] :LSEQuencer:TDSCdma:TDEMod:PHASe:SHIFt:DETection:AUTO ON|OFF|1|0

[ :SENSE ] :LSEQuencer:TDSCdma:TDEMod:PHASe:SHIFt:DETection:AUTO?

[ :SENSE ] :LSEQuencer:TDSCdma:TDEMod:ALPHa <real>

[ :SENSE ] :LSEQuencer:TDSCdma:TDEMod:ALPHa?

[ :SENSE ] :LSEQuencer:TDSCdma:TDEMod:THReshold:CHANnel <real>

[ :SENSE ] :LSEQuencer:TDSCdma:TDEMod:THReshold:CHANnel?

[ :SENSE ] :LSEQuencer:TDSCdma:TDEMod:SPECTrum:MIRRor NORMAl|INVert

[ :SENSE ] :LSEQuencer:TDSCdma:TDEMod:SPECTrum:MIRRor?
```

TD-SCDMA PvT results

Index	Result Parameter
0	Overall Pass/Fail result shows the limit check result of Off power before, average power over -33rd ~ -14th chip, and Off power after to their upper limit: -65 dBm, -50 dBm and -65 dBm respectively. Only when all these 3 powers are below their upper limits, can this overall pass/fail result be pass. This is the only pass fail result. (0.0 = pass, 1.0 = fail, -1.0: Not tested)
1	Mean power is the mean power (in dBm) of the range specified by Analysis Time Slot and Measurement Time Slots in the most recently acquired data. If averaging is on and average number is N, mean power is calculated after N PVT traces are merged.
2	Burst width is the width of the first set of continuous active slots in the range specified by Analysis Time slot and Measured Time Slots. If averaging is on and average number is N, burst width result is calculated by averaging N burst width results.
3	Burst start time is the start time of the burst referring to the start of the analysis interval. If averaging is on and average number is N, the final burst width results is calculated by averaging N burst start time results.
4	Ramp up time is the time difference between 10% and 90% voltage points (relative to peak) on the positive slope of the burst, here burst has the same meaning in Burst width. If averaging is on and average number is N, rump up time is calculated after N PVT traces are merged.
5	Ramp down time is the time difference between 90% and 10% voltage points (relative to peak) on the negative slope of the burst, here burst has the same meaning in Burst width. If averaging is on and average number is N, rump down time is calculated after N PVT traces are merged.
6	Off power is calculated as the averaged power between the -48th and -16th chip before the burst start time. If average is on and average number is N, the off power is calculated after N PVT traces are merged.
7	Maximum power is the maximum peak level in the range specified by Analysis Time Slot and Measured Time Slots (in dBm). If average is on and average number is N, the maximum power is calculated after N PVT traces are merged.
8	Minimum power is the minimum peak level in the range specified by Analysis Time Slot and Measured Time Slots (in dBm). If average is on and average number is N, the minimum power is calculated after N PVT traces are merged.
9	Trace sample interval is a floating point number representing the time between samples of the merged envelop trace data, which could be read by using FETCh:LSEQuencer<l>:ACQuire<m>:ASTep<n>:TDPVt:TRACe ? If average is on and average number is N, this result is calculated after N PVT traces are merged.

10	Trace sample number is the number of data points in the merged envelop trace data, which could be read by using <code>FETCh:LSEQuencer<l>:ACQuire<m>:ASTep<n>:TDPVt:TRACe?</code> Only up to 2000 envelop trace points can be returned. So, the envelop trace returned may be decimated. If average is on and average number is N, this result is calculated after N PVT traces are merged.
11	Off power before is the averaged power between the start time of the analysis interval and the -34th chip before the burst start time. This value is used for the limit check. The upper limit is -65 dBm. Though limited by analysis interval, this result is derived from 8960 Tdscdma Transmit ON/OFF Power result: Range 1 OFF Power, whereas it is the averaged power or the highest chip power between -160th to -34th chips of the averaged trace for TS1, and -864th to -34th chips of the averaged trace for UpPTS. If average is on and average number is N, this result is calculated after N PVT traces are merged.
12	Average power over -33rd ~ -14th chip is the averaged power between -33rd chip to -14th chip of the burst. This value is used for the limit check. Its upper limit is -50 dBm. This result is derived from the 8960 Tdscdma Transmit ON/OFF Power result: Range 2 OFF Power, which is the averaged or highest chip power between -33rd to -14th chips of the averaged trace. If average is on and average number is N, this result is calculated after N PVT traces are merged.
13	Off power after is the averaged power between the 860th chips to the end of the analysis interval. This result is derived from the 8960 Tdscdma Transmit ON/OFF Power result: Range 3 OFF Power, which is the averaged power between 860th to 1711st chips of the averaged trace. If average is on and average number is N, this result is calculated after N PVT traces are merged.
14	Max burst start time is the maximum start time of the burst referring to the start of the analysis interval. If averaging is on and average number is N, this results is the maximum value of the N burst start time results.

The following command is used to retrieve the Envelope Trace Results:

MEAS | READ | FETCh:LSEQuencer:ACQuire{1...512}:ASTep{1...1000}:TDPVt:TRACe?

TDSCDMA PVT trace results are trace envelope powers (averaged over time intervals of one chip duration) in unit of dBm. They are comma-separated and the length is the trace sample number result in the TDSCDMA PVT general results described above.

The following command is used to retrieve the Upper Limit Results:

MEAS | READ | FETCh:LSEQuencer:ACQuire{1...512}:ASTep{1...1000}:TDPVt:ULIMit?

TDSCDMA PVT upper limit results are upper limit values of the trace results point by point in unit of dBm. They are comma-separated and the length is the trace sample number result in the TDSCDMA PVT general results described above.

Adjacent Channel Power (ACP)

This section provides the remote control SCPI commands for the TD-SCDMA Adjacent Channel Power (ACP) measurement from within the List Sequencer. This measurement is available only if you have the TD-SCDMA measurement application licensed on the test set.

For more detailed information about the ACP measurement, refer to the online help associated with the TD-SCDMA measurement application, which is also available in PDF format (“User’s and Programmer’s Reference”) on the Keysight website, www.keysight.com/find/e6650a.

You can also refer to the measurement guide for the X-series TD-SCDMA measurement application, which is available on the Keysight website, www.keysight.com/find/mxa.

Adjacent Channel Power (ACP) measurement SCPI commands

There is a set of SCPI commands available to program the TD-SCDMA ACP measurement when it is used in the TD-SCDMA mode. To set up the TD-SCDMA measurements from within the Sequence Analyzer mode you need to prefix the SCPI commands with `LSEQuencer:TDSCdma`. For example, the `[:SENSe] :ACPpower` part of the ACP SCPI commands are replaced with `[:SENSe] :LSEQuencer:TDSCdma:ACPpower`.

The following commands are used to set up the ACP measurement.

```
[ :SENSe ] :LSEQuencer:TDSCdma:ACPpower:BANDwidth [ :RESolution ]
[ :SENSe ] :LSEQuencer:TDSCdma:ACPpower:BANDwidth:SHAPE
[ :SENSe ] :LSEQuencer:TDSCdma:ACPpower:BANDwidth:TYPE
[ :SENSe ] :LSEQuencer:TDSCdma:ACPpower:CARRier [ 1 ] | 2 :COUNT
[ :SENSe ] :LSEQuencer:TDSCdma:ACPpower:CARRier [ 1 ] | 2 :REFerence
[ :SENSe ] :LSEQuencer:TDSCdma:ACPpower:CARRier [ 1 ] | 2 :RCARRier:AUTO
[ :SENSe ] :LSEQuencer:TDSCdma:ACPpower:CARRier [ 1 ] | 2 :RCFrequency
[ :SENSe ] :LSEQuencer:TDSCdma:ACPpower:CARRier [ 1 ] | 2 :RCFrequency:AUTO
[ :SENSe ] :LSEQuencer:TDSCdma:ACPpower:CARRier [ 1 ] | 2 [ :POWER ]
[ :SENSe ] :LSEQuencer:TDSCdma:ACPpower:CARRier [ 1 ] | 2 :AUTO [ :STATe ]
[ :SENSe ] :LSEQuencer:TDSCdma:ACPpower:CARRier [ 1 ] | 2 :CPSD
[ :SENSe ] :LSEQuencer:TDSCdma:ACPpower:CARRier [ 1 ] | 2 :LIST:COUPlE
[ :SENSe ] :LSEQuencer:TDSCdma:ACPpower:CARRier [ 1 ] | 2 :LIST:PPResent
[ :SENSe ] :LSEQuencer:TDSCdma:ACPpower:CARRier [ 1 ] | 2 :LIST:WIDTh
[ :SENSe ] :LSEQuencer:TDSCdma:ACPpower:CARRier [ 1 ] | 2 :LIST:
BANDwidth [ :INTegration ]
[ :SENSe ] :LSEQuencer:TDSCdma:ACPpower:CARRier [ 1 ] | 2 :LIST:METHod
[ :SENSe ] :LSEQuencer:TDSCdma:ACPpower:CARRier [ 1 ] | 2 :LIST:FILTer:ALPHa
[ :SENSe ] :LSEQuencer:TDSCdma:ACPpower:OFFSet [ 1 ] | 2 :LIST [ :FREQuency ]
```

TD-SCDMA Programming Commands
 Adjacent Channel Power (ACP)

```
[ :SENSE ] :LSEQuencer :TDSCdma :ACPower :OFFSet [1] | 2 :LIST :STATE
[ :SENSe ] :LSEQuencer :TDSCdma :ACPower :OFFSet [1] | 2 :LIST :BANDwidth
[ :SENSe ] :LSEQuencer :TDSCdma :ACPower :OFFSet [1] | 2 :LIST :BANDwidth :RESolution
[ :SENSe ] :LSEQuencer :TDSCdma :ACPower :OFFSet [1] | 2 :LIST :BANDwidth :
RESolution :AUTO
[ :SENSe ] :LSEQuencer :TDSCdma :ACPower :OFFSet [1] | 2 :LIST :BANDwidth :SHAPE
[ :SENSe ] :LSEQuencer :TDSCdma :ACPower :OFFSet [1] | 2 :LIST :BANDwidth :TYPE
[ :SENSe ] :LSEQuencer :TDSCdma :ACPower :OFFSet [1] | 2 :LIST :ABSolute
[ :SENSe ] :LSEQuencer :TDSCdma :ACPower :OFFSet [1] | 2 :LIST :TEST
[ :SENSe ] :LSEQuencer :TDSCdma :ACPower :OFFSet [1] | 2 :LIST :RCARrier
[ :SENSe ] :LSEQuencer :TDSCdma :ACPower :OFFSet [1] | 2 :LIST :RPSDensity
```

ACP results

Index	Result Parameter
0	Overall Pass/Fail result - returns 24 scalar values of the pass/fail (0.0 = pass, 1.0 = fail) determined by testing the relative to the reference carrier and by testing the absolute power limit of the offset frequencies (measured as total power in dBm)
	1. Lower Offset A - relative limit test result
	2. Lower Offset A - absolute limit test result
	3. Upper Offset A - relative limit test result
	4. Upper Offset A - absolute limit test result
	5. Lower Offset B - relative limit test result
	6. Lower Offset B - absolute limit test result
	7. Upper Offset B - relative limit test result
	8. Upper Offset B - absolute limit test result
	...
	21. Lower Offset F - relative limit test result
	22. Lower Offset F - absolute limit test result
	23. Upper Offset F - relative limit test result
	24. Upper Offset F - absolute limit test result

1	<p>Carrier Powers - returns three scalar values representing overall pass/fail, carrier power, and reference carrier power</p> <ol style="list-style-type: none"> 1. Overall Pass/Fail 2. Total Carrier Power 3. Reference Carrier Power <p>If meas type is Total Power Reference, these results are returned in units of dBm. If Meas Type is Power Spectral Density Reference, these results are returned in units of dBm/Hz or dBm/MHz.</p>
2	<p>Power Results</p> <ol style="list-style-type: none"> 1. Channel (1) - relative power 2. Channel (1) - absolute power 3. Channel (1) - relative power 4. Channel (1) - absolute power ... 23. Channel (1) - relative power 24. Channel (1) - absolute power 25. Lower Offset A - relative power 26. Lower Offset A - absolute power 27. Upper Offset A - relative power 28. Upper Offset A - absolute power 29. Lower Offset B - relative power 30. Lower Offset B - absolute power 31. Upper Offset B - relative power 32. Upper Offset B - absolute power ... 45. Lower Offset F - relative power 46. Lower Offset F - absolute power 47. Upper Offset F - relative power 48. Upper Offset F - absolute power <p>If Meas Type is Total Power Reference, these results are returned in units of dBm. If Meas Type is Power Spectral Density Reference, these results are returned in units of dBm/Hz or dBm/MHz.</p>

Spectrum Emissions Mask (SEM)

This section provides the remote control SCPI commands for the TD-SCDMA Spectrum Emissions Mask (SEM) measurement from within the List Sequencer. This measurement is available only if you have the TD-SCDMA measurement application licensed on the test set.

For more detailed information about the SEM measurement, refer to the online help associated with the TD-SCDMA measurement application, which is also available in PDF format (“User’s and Programmer’s Reference”) on the Keysight website, www.keysight.com/find/e6650a.

You can also refer to the measurement guide for the X-series TD-SCDMA measurement application, which is available on the Keysight website, www.keysight.com/find/mxa.

SEM measurement SCPI commands

There is a set of SCPI commands available to program the TD-SCDMA SEM measurement when it is used in the TD-SCDMA mode. To set up the TD-SCDMA measurements from within the Sequence Analyzer mode you need to prefix the SCPI commands with `LSEQuencer:TDSCdma`. For example, the `[:SENSe]:SEMAsk` part of the SEM SCPI commands are replaced with:

```
[:SENSe]:LSEQuencer:TDSCdma:SEMAsk
```

The following commands are used to set up the SEM measurement.

```
[:SENSe]:LSEQuencer:TDSCdma:SEMAsk:TYPE
```

```
[:SENSe]:LSEQuencer:TDSCdma:SEMAsk:BANDwidth[1]|2:INTegration
```

```
[:SENSe]:LSEQuencer:TDSCdma:SEMAsk:FREQuency[1]|2:SPAN
```

```
[:SENSe]:LSEQuencer:TDSCdma:SEMAsk:BANDwidth[1]|2[:RESolution]
```

```
[:SENSe]:LSEQuencer:TDSCdma:SEMAsk:BANDwidth[1]|2[:RESolution]:AUTO
```

```
[:SENSe]:LSEQuencer:TDSCdma:SEMAsk:CARRier[:POWER]
```

```
[:SENSe]:LSEQuencer:TDSCdma:SEMAsk:CARRier:AUTO[:STATE]
```

```
[:SENSe]:LSEQuencer:TDSCdma:SEMAsk:CARRier:CPSD
```

```
[:SENSe]:LSEQuencer:TDSCdma:SEMAsk:CARRier:PEAK[:POWER]
```

```
[:SENSe]:LSEQuencer:TDSCdma:SEMAsk:OFFSet[1]|2:LIST:FREQuency:START
```

```
[:SENSe]:LSEQuencer:TDSCdma:SEMAsk:OFFSet[1]|2:LIST:STATE
```

```
[:SENSe]:LSEQuencer:TDSCdma:SEMAsk:OFFSet[1]|2:LIST:FREQuency:STOP
```

```
[:SENSe]:LSEQuencer:TDSCdma:SEMAsk:OFFSet[1]|2:LIST:SIDE
```

```
[:SENSe]:LSEQuencer:TDSCdma:SEMAsk:OFFSet[1]|2:LIST:BANDwidth[:RESolution]
```

```
[:SENSe]:LSEQuencer:TDSCdma:SEMAsk:OFFSet[1]|2:LIST:BANDwidth[:RESolution]:AUTO
```

```
[:SENSe]:LSEQuencer:TDSCdma:SEMAsk:OFFSet[1]|2:LIST:BANDwidth:IMULti
```

```
[:SENSe]:LSEQuencer:TDSCdma:SEMAsk:OFFSet[1]|2:LIST:START:ABSolute
```

```
[:SENSe]:LSEQuencer:TDSCdma:SEMAsk:OFFSet[1]|2:LIST:STOP:ABSolute
```

TD-SCDMA Programming Commands
Spectrum Emissions Mask (SEM)

```
[ :SENSe ] :LSEQuencer :TDSCdma :SEMAsk :OFFSet [ 1 ] | 2 :LIST :STOP :ABSoluteCOUPle  
[ :SENSe ] :LSEQuencer :TDSCdma :SEMAsk :OFFSet [ 1 ] | 2 :LIST :STARt :RCARrier  
[ :SENSe ] :LSEQuencer :TDSCdma :SEMAsk :OFFSet [ 1 ] | 2 :LIST :STOP :RCARrier  
[ :SENSe ] :LSEQuencer :TDSCdma :SEMAsk :OFFSet [ 1 ] | 2 :LIST :STOP :RCARrier :COUPle  
[ :SENSe ] :LSEQuencer :TDSCdma :SEMAsk :OFFSet [ 1 ] | 2 :LIST :TEST  
[ :SENSe ] :LSEQuencer :TDSCdma :SEMAsk :FILTer [ :RRC ] [ :STATe ]  
[ :SENSe ] :LSEQuencer :TDSCdma :SEMAsk :FILTer [ :RRC ] :ALPHa  
[ :SENSe ] :LSEQuencer :TDSCdma :SEMAsk :LIMits  
[ :SENSe ] :LSEQuencer :TDSCdma :SEMAsk :TYPE  
:TRACe :LSEQuencer :TDSCdma :SEMAsk :TYPE
```

TD-SCDMA Programming Commands
Spectrum Emissions Mask (SEM)

SEM results

Index	Result Parameter
0	Overall Pass/Fail result shows the mask test result (0 = pass, 1 = fail, -1 not tested)
1	<p>Main Results</p> <ol style="list-style-type: none"> 1. Absolute power at center frequency (reference) area (dBm) 2. Peak Frequency in the center frequency (reference) area (Hz) 3. Relative integrated power on the negative offset A (dBc) 4. Absolute integrated power on the negative offset A (dBm or dBm/Hz) 5. Relative peak power on the negative offset A (dBc) 6. Absolute peak power on the negative offset A (dBm or dBm/Hz) 7. Peak power offset frequency from the center frequency in the negative offset A (Hz) 8. Relative integrated power on the positive offset A (dBc) 9. Absolute integrated power on the positive offset A (dBm or dBm/Hz) 10. Relative peak power on the positive offset A (dBc) 11. Absolute peak power on the positive offset A (dBm or dBm/Hz) 12. Peak power offset frequency from the center frequency in the positive offset A (Hz) 13. Relative integrated power on the negative offset B (dBc) <p>...</p> <ol style="list-style-type: none"> 61. Absolute peak power on the positive offset F (dBm or dBm/Hz) 62. Peak power offset frequency from the center frequency in the positive offset F (Hz) 63. Minimum margin from limit line on the negative offset A (dB) 64. Minimum margin from limit line on the positive offset A (dB) 65. Minimum margin from limit line on the negative offset B (dB) 66. Minimum margin from limit line on the positive offset B (dB) 67. Minimum margin from limit line on the negative offset C (dB) 68. Minimum margin from limit line on the positive offset C (dB) 69. Minimum margin from limit line on the negative offset D (dB) 70. Minimum margin from limit line on the positive offset D (dB) 71. Minimum margin from limit line on the negative offset E (dB) 72. Minimum margin from limit line on the positive offset E (dB) 73. Minimum margin from limit line on the negative offset F (dB) 74. Minimum margin from limit line on the positive offset F (dB) <p>The unit for the absolute power results varies depending on the measurement type:</p> <p>If the measurement type is Total Power Reference, these results are expressed in dBm.</p> <p>If the measurement type is Power Spectral Density Reference, these results are expressed in dBm/Hz.</p>

Occupied Bandwidth (OBW)

This section provides the remote control SCPI commands for the TD-SCDMA Occupied Bandwidth (OBW) measurement from within the List Sequencer. This measurement is available only if you have the TD-SCDMA measurement application licensed on the test set.

For more detailed information about the OBW measurement, refer to the online help associated with the TD-SCDMA measurement application, which is also available in PDF format (“User’s and Programmer’s Reference”) on the Keysight website, www.keysight.com/find/e6650a.

You can also refer to the measurement guide for the X-series TD-SCDMA measurement application, which is available on the Keysight website, www.keysight.com/find/mxa.

OBW measurement SCPI commands

There is a set of SCPI commands available to program the TD-SCDMA OBW measurement when it is used in the TD-SCDMA mode. To set up the TD-SCDMA measurements from within the Sequence Analyzer mode you need to prefix the SCPI commands with LSEQuencer:TD-SCDMA. For example, the [:SENSe]:OBWidth part of the OBW SCPI commands are replaced with [:SENSe]:LSEQuencer:TDSCdma:OBWidth.

The following commands are used to set up the OBW measurement.

```
[:SENSe]:LSEQuencer:TDSCdma:OBWidth:BANDwidth[:RESolution]
[:SENSe]:LSEQuencer:TDSCdma:OBWidth:BANDwidth:SHAPE
[:SENSe]:LSEQuencer:TDSCdma:OBWidth:PERCent
[:SENSe]:LSEQuencer:TDSCdma:OBWidth:XDB
CALCulate: [SENSe]:LSEQuencer:TDSCdma:OBWidth:LIMit:FBLimit
CALCulate: [SENSe]:LSEQuencer:TDSCdma:OBWidth:LIMit[:TEST]
[:SENSe]:LSEQuencer:TDSCdma:OBWidth:FREQuency:SPAN
[:SENSe]:LSEQuencer:TDSCdma:OBWidth:FREQuency:SPAN:FULL
[:SENSe]:LSEQuencer:TDSCdma:OBWidth:FREQuency:SPAN:PREVIOUS
```

OBW results

Index	Result Parameter
0	Overall Pass/Fail
1	Main Results 1. Occupied Bandwidth (Hz) 2. Transmit Frequency Error (Hz) 3. x dB bandwidth (Hz)

Modulation Accuracy (Rho)

This section provides the remote control SCPI commands for the TD-SCDMA Modulation Accuracy (Rho) measurement from within the List Sequencer. This measurement is available only if you have the TD-SCDMA measurement application licensed on the test set.

For more detailed information about the Modulation Accuracy measurement, refer to the online help associated with the TD-SCDMA measurement application, which is also available in PDF format (“User’s and Programmer’s Reference”) on the Keysight website, www.keysight.com/find/e6650a.

You can also refer to the measurement guide for the X-series TD-SCDMA measurement application, which is available on the Keysight website, www.keysight.com/find/mxa.

Modulation Accuracy measurement SCPI commands

There is a set of SCPI commands available to program the TD-SCDMA Modulation Accuracy measurement when it is used in the TD-SCDMA mode. To set up the TD-SCDMA measurements from within the Sequence Analyzer mode you need to prefix the SCPI commands with `LSEQuencer:TDSCDMA`. For example, the `[:SENSe] :RHO` part of the modulation accuracy SCPI commands are replaced with: `[:SENSe] :LSEQuencer:TDSCdma:RHO`

The following commands are used to set up the modulation accuracy measurement.

```
[ :SENSe ] :LSEQuencer:TDSCdma:EVM:RINTerval  
[ :SENSe ] :LSEQuencer:TDSCdma:EVM:ANALysis:SUBFrame  
:CALCulate:LSEQuencer:TDSCdma:EVM:LIMit [1] :RMS  
:CALCulate:LSEQuencer:TDSCdma:EVM:LIMit2:RMS  
:CALCulate:LSEQuencer:TDSCdma:EVM:LIMit [1] :PEAK  
:CALCulate:LSEQuencer:TDSCdma:EVM:LIMit2:PEAK  
:CALCulate:LSEQuencer:TDSCdma:EVM:LIMit [1] :RHO  
:CALCulate:LSEQuencer:TDSCdma:EVM:LIMit2:RHO  
:CALCulate:LSEQuencer:TDSCdma:EVM:LIMit [1] :PCDE  
:CALCulate:LSEQuencer:TDSCdma:EVM:LIMit2:PCDE  
:CALCulate:LSEQuencer:TDSCdma:EVM:LIMit [1] :FERRor  
:CALCulate:LSEQuencer:TDSCdma:EVM:LIMit2:FERRor
```

Modulation Accuracy (Rho) results

Index	Result Parameter
0	Overall Pass/Fail Result 0:Pass, 1:Fail, -1:Not tested
1	RMS EVM pass/fail result (1.0 = fail, 0.0 = pass)
2	Peak EVM pass/fail result (1.0 = fail, 0.0 = pass)
3	Rho pass/fail result (1.0 = fail, 0.0 = pass)
4	Peak Code Domain Error pass/fail result (1.0 = fail, 0.0 = pass)
5	Frequency Error pass/fail result (1.0 = fail, 0.0 = pass)
6	RMS EVM (Average) is a floating point number (in percent) of EVM over the entire measurement area.
7	Peak EVM (Peak Hold) is a floating point number (in percent) of the Peak EVM in the entire measurement area.
8	Magnitude Error (Average) is a floating point number (in percent) of the average magnitude error over the entire measurement area.
9	Magnitude Error (Peak Hold) is a floating point number (in percent) of the Peak magnitude error over the entire measurement area.
10	Phase Error (Average) is a floating point number (in degree) of the average phase error over the entire measurement area.
11	Phase Error (Peak Hold) is a floating point number (in degree) of the Peak phase error over the entire measurement area.
12	I/Q Origin Offset (Average) is a floating point number (in dB) of the I and Q error (magnitude squared) offset from the origin.
13	Frequency Error (Average) is a floating point number (in Hz) of the frequency error in the measured signal.
14	Rho (Average) is a floating point number of Rho.
15	Quadrature Error (Average) is a floating point number (in degree) of the quadrature error in the measured signal.
16	Gain Imbalance (Average) is a floating point number (in dB) of the gain imbalance in the measured signal.
17	Peak Code Domain Error (Peak Hold) is a floating point number (in dB) of peak hold Peak Code Domain Error (of all the code channels, including active and inactive, in average cycle) of the selected timeslot.
18	Peak Code Domain Error - Code Length (Peak Hold) is the code length of peak hold Peak CDE (in average cycle) of the selected timeslot.
19	Peak Code Domain Error - Code Index (Peak Hold) is the code index of peak hold Peak CDE (in average cycle) of the selected timeslot.
20	Peak Active Code Domain Error (Peak Hold) is a floating point number (in dB) of the peak hold Peak Active CDE (of active code channels, in average cycle) of the selected timeslot.
21	Peak Active Code Domain Error - Code Length (Peak Hold) is the code length of peak hold Peak Active CDE (in average cycle) of the selected timeslot.

TD-SCDMA Programming Commands
Modulation Accuracy (Rho)

Index	Result Parameter
22	Peak Active Code Domain Error - Code Index (Peak Hold) is the code index of peak hold Peak Active CDE (in average cycle) of the selected timeslot.
23	Number of active channels.
24	Time Offset (Average) is a floating point number (in chips) of the averaged composite timing error (in average cycle) of the selected timeslot, relative to the timing reference (DwPTS/UpPTS/Trig).

Modulation Accuracy (Rho) results selection

This command allows you to specify which of the possible result metrics from the TD-SCDMA Modulation Accuracy measurement are returned. The 1st (leftmost) value in the SCPI command represents Index 0.

The “Number of Results” value returned ahead of the measurement results is dependent on the selection made here. The result metrics that are selected by default are indexes 0-25 in the table of results for the measurement.

This selection is set for the entire Sequence. Should you want a specific result selection returned for one particular analysis step and not the rest, this can be achieved by using delta parameters.

Key Path	SCPI only
Remote Command	[:SENSe] :LSEQuencer :TDSCdma :RHO :RESult :SELEction ON OFF 0 1, ON OFF 0 1 [:SENSe] :LSEQuencer :TDSCdma :RHO :RESult :SELEction?
Example	:LSEQ:TDSC:RHO:RES:SEL 1,1 :LSEQ:TDSC:RHO:RES:SEL?
Preset	1,1,1,1,1,1,1,1,1,1,1,1,1,1,1,1,1,1,0,1,1,1,1,1,1,1,1,1,1

QPSK EVM

This section provides information related to the TD-SCDMA QPSK EVM measurement from within the List Sequencer. This measurement is available only if you have the TD-SCDMA measurement application licensed on the test set.

In sequence analyzer mode only (not in TD-SCDMA mode), QPSK EVM results can be collected for TD-SCDMA. However, measurement setup commands are not available in this case. The measurement is available only with the following default settings:

- RRC Filter is ON, Filter Alpha is 0.22
- Chip rate is 1.28MHz
- EVM Result I/Q Offset is Standard
- Meas Interval is 864 chips
- Spectrum Inversion is Normal
- Frequency Error limit is 100 Hz
- RMS EVM limit is 17.5

QPSK EVM measurement SCPI commands

Measurement setup commands for QPSK EVM are not available in the case of TD-SCDMA. In this case, measurement results are collected using the default setup described above..

QPSK EVM results

Index	Result Parameter
0	Overall Pass/Fail Result shows the mask test result (0.0 = pass, 1.0 = fail, -1.0: Not tested)
1	RMS EVM pass/fail result (1.0 = fail, 0.0 = pass) Returns the result of whether the RMS EVM passed the limit set in the measurement setup.
2	Peak EVM pass/fail result (1.0 = fail, 0.0 = pass) Returns the result of whether the Peak EVM passed the limit set in the measurement setup.
3	Magnitude Error pass/fail result (1.0 = fail, 0.0 = pass) Returns the result of whether the Magnitude Error passed the limit set in the measurement setup.
4	Phase Error pass/fail result (1.0 = fail, 0.0 = pass) Returns the result of whether the Phase Error passed the limit set in the measurement setup.
5	Frequency Error pass/fail result (1.0 = fail, 0.0 = pass) Returns the result of whether the Freq Error passed the limit set in the measurement setup.
6	IQ Original Offset pass/fail result (1.0 = fail, 0.0 = pass) Returns the result of whether the IQ Original Offset passed the limit set in the measurement setup.
7	RMS EVM (Average) is a floating point number (in percent) of EVM over the entire measurement interval.
8	RMS EVM maximum is the maximum RMS EVM over the average group. If averaging is off, then it returns result for the measurement interval.
9	Peak EVM is a floating point number (in percent) of the Peak EVM in the measurement interval.
10	Peak EVM maximum is the maximum Peak EVM over the average group. If averaging is off, then it returns result for the measurement interval.
11	Magnitude Error is a floating point number (in percent) of averaged magnitude error over the entire measurement interval.
12	Magnitude Error maximum is a floating point number over the average group. If averaging is off, then it returns result for the measurement interval.
13	Phase Error is a floating point number (in degrees) of the averaged phase error over the entire measurement interval.
14	Phase Error maximum is the maximum Phase Error over the average group. If averaging is off, then it returns result for the measurement interval.
15	Frequency Error is a floating point number (in Hz) of the frequency error in the measured signal.
16	Frequency Error maximum is the maximum frequency error over the average group. If averaging is off, then it returns result for the measurement interval.
17	I/Q Origin Offset is a floating point number (in dB) of the I and Q error (magnitude squared) offset from the origin.

NOTE The following QPSK EVM results, which would be returned if the measurement could be run in the TD-SCDMA measurement mode, are not returned when the measurement is run in Sequence Analyzer mode:

- Unprocessed I/Q Trace Data
 - EVM Trace
 - Magnitude Error Trace
 - Phase Error Trace
 - Corrected Measured Trace
-

Code Domain Power (CDP)

This section provides the remote control SCPI commands for the TD-SCDMA Code Domain Power (CDP) measurement from within the List Sequencer. This measurement is available only if you have the TD-SCDMA measurement application licensed on the test set.

For more detailed information about the CDP measurement, refer to the online help associated with the TD-SCDMA measurement application, which is also available in PDF format (“User’s and Programmer’s Reference”) on the Keysight website, www.keysight.com/find/e6650a.

You can also refer to the measurement guide for the X-series TD-SCDMA measurement application, which is available on the Keysight website, www.keysight.com/find/mxa.

Code Domain Power (CDP) measurement SCPI commands

There is a set of SCPI commands available to program the TD-SCDMA CDP measurement when it is used in the TD-SCDMA mode. To set up the TD-SCDMA measurements from within the Sequence Analyzer mode you need to prefix the SCPI commands with `LSEQuencer:TDSCdma`. For example, the `[:SENSe]:CDPower` part of the CDP SCPI commands are replaced with `[:SENSe]:LSEQuencer:TDSCdma:CDPower`.

The following commands are used to set up the CDP measurement.

```
[:SENSe]:LSEQuencer:TDSCdma:CDPower:RINTerval
```

```
[:SENSe]:LSEQuencer:TDSCdma:CDPower:ANALysis:SUBFrame
```

```
[:SENSe]:LSEQuencer:TDSCdma:CDPower:SCLength
```

```
[:SENSe]:LSEQuencer:TDSCdma:CDPower:CDCHannel
```

CDP results

Index	Result Parameter
0	Unnormalized Code Domain Power Vector (float) [dBm] - Return the vector containing unnormalized CDP information for the specified code channel, as a series of comma-separated points. There are 16 numbers in this vector. If the channel's code length (indicated by the value on the same position within the Code Length Vector) is less than the max spreading code length 16, the power is duplicated (16/spreading code length) times. Its data are lined according to the increasing code index.
1	Normalized Code Domain Power Vector (float) [dB] - Return the vector containing normalized CDP information for the specified code channel, as a series of comma-separated points. There are 16 numbers in this vector. If the channel's code length (indicated by the value on the same position within the Code Length Vector) is less than the max spreading code length 16, the power is duplicated (16/spreading code length) times. Its data are lined according to the increasing code index.
2	Unnormalized Code Domain Error Vector (float) [dBm] - Return the vector containing unnormalized CDE information for the specified code channel, as a series of comma-separated points. There are 16 numbers in this vector. If the channel's code length (indicated by the value on the same position within the Code Length Vector) is less than the max spreading code length 16, the error is duplicated (16/spreading code length) times. Its data are lined according to the increasing code index.
3	Normalized Code Domain Error Vector (float) [dB] - Return the vector containing normalized CDE information for the specified code channel, as a series of comma-separated points. There are 16 numbers in this vector. If the active channel's code length (specified by the value on the same position within the Code Length Vector) is less than the max spreading code length 16, the error is duplicated (16/spreading code length) times. Its data are lined according to the increasing code index.

Loopback Bit Error Rate (BER)

This section provides the remote control SCPI commands for the TD-SCDMA Loopback Bit Error Rate (BER) measurement from within the List Sequencer. This measurement is available only if you have the TD-SCDMA measurement application licensed on the test set.

For more detailed information about the BER measurement, refer to the online help associated with the TD-SCDMA measurement application, which is also available in PDF format (“User’s and Programmer’s Reference”) on the Keysight website, www.keysight.com/find/e6650a.

You can also refer to the measurement guide for the X-series TD-SCDMA measurement application, which is available on the Keysight website, www.keysight.com/find/mxa.

Loopback Bit Error Rate (BER) measurement SCPI commands

There is a set of SCPI commands available to program the TD-SCDMA BER measurement when it is used in the TD-SCDMA mode. To set up the TD-SCDMA measurements from within the Sequence Analyzer mode you need to prefix the SCPI commands with `LSEQuencer:TDSCDMA`. For example, the `[:SENSe]:CDPower` part of the BER SCPI commands are replaced with `[:SENSe]:LSEQuencer:TDSCdma:CDPower`.

The following commands are used to set up the BER measurement.

```
[:SENSe]:LSEQuencer:TDSCdma:CDPower:RINTerval
```

```
[:SENSe]:LSEQuencer:TDSCdma:CDPower:ANALysis:SUBFrame
```

```
[:SENSe]:LSEQuencer:TDSCdma:CDPower:SCLength
```

```
[:SENSe]:LSEQuencer:TDSCdma:CDPower:CDCHannel
```

BER results

Index	Result Parameter
0	Loopback bit error ratio.
1	Total tested bit number.
2	Failed bit number.
3	Reserve.

18 WLAN Programming Commands

This chapter lists all the commands used to set up the WLAN measurements from within the List Sequencer.

NOTE See also: mode parameters related to WLAN, as described in “[Mode and Measurement Parameters](#)” on page 52.

The chapter topics are:

- [Spectrum Emissions Mask \(SEM\)](#)
- [Occupied Bandwidth \(OBW\)](#)
- [Modulation Accuracy \(EVM & Spectral Flatness\)](#)
- [MIMO Modulation Accuracy \(EVM\)](#)

Spectrum Emissions Mask (SEM)

This section provides the remote control SCPI commands for the WLAN Spectrum Emissions Mask (SEM) measurement from within the List Sequencer. This measurement is available only if you have the WLAN measurement application licensed on the test set.

For more detailed information about the SEM measurement, refer to the online help associated with the WLAN measurement application, which is also available in PDF format (“User’s and Programmer’s Reference”) on the Keysight website, www.keysight.com/find/e6650a.

You can also refer to the measurement guide for the X-series WLAN measurement application, which is available on the Keysight website, www.keysight.com/find/mxa.

SEM measurement SCPI commands

There is a set of SCPI commands available to program the WLAN SEM measurement when it is used in the WLAN mode. To set up the WLAN measurements from within the Sequence Analyzer mode you need to prefix the SCPI commands with `LSEQuencer:WLAN`. For example, the `[:SENSe]:SEMAsk` part of the SEM SCPI commands are replaced with:

```
[:SENSe]:LSEQuencer:WLAN:SEMAsk
```

The following commands are used to set up the SEM measurement.

```
[:SENSe]:LSEQuencer:WLAN:SEMAsk:TYPE
```

```
[:SENSe]:LSEQuencer:WLAN:SEMAsk:BANDwidth[1]|2:INTegration
```

```
[:SENSe]:LSEQuencer:WLAN:SEMAsk:FREQuency[1]|2:SPAN
```

```
[:SENSe]:LSEQuencer:WLAN:SEMAsk:BANDwidth[1]|2[:RESolution]
```

```
[:SENSe]:LSEQuencer:WLAN:SEMAsk:BANDwidth[1]|2[:RESolution]:AUTO
```

```
[:SENSe]:LSEQuencer:WLAN:SEMAsk:CARRier[:POWER]
```

```
[:SENSe]:LSEQuencer:WLAN:SEMAsk:CARRier:AUTO[:STATE]
```

```
[:SENSe]:LSEQuencer:WLAN:SEMAsk:CARRier:CPSD
```

```
[:SENSe]:LSEQuencer:WLAN:SEMAsk:CARRier:PEAK[:POWER]
```

```
[:SENSe]:LSEQuencer:WLAN:SEMAsk:OFFSet[1]|2:LIST:FREQuency:START
```

```
[:SENSe]:LSEQuencer:WLAN:SEMAsk:OFFSet[1]|2:LIST:STATE
```

```
[:SENSe]:LSEQuencer:WLAN:SEMAsk:OFFSet[1]|2:LIST:FREQuency:STOP
```

```
[:SENSe]:LSEQuencer:WLAN:SEMAsk:OFFSet[1]|2:LIST:SIDE
```

```
[:SENSe]:LSEQuencer:WLAN:SEMAsk:OFFSet[1]|2:LIST:BANDwidth[:RESolution]
```

```
[:SENSe]:LSEQuencer:WLAN:SEMAsk:OFFSet[1]|2:LIST:BANDwidth[:RESolution]:AUTO
```

```
[:SENSe]:LSEQuencer:WLAN:SEMAsk:OFFSet[1]|2:LIST:BANDwidth:IMULTi
```

```
[:SENSe]:LSEQuencer:WLAN:SEMAsk:OFFSet[1]|2:LIST:START:ABSolute
```

```
[:SENSe]:LSEQuencer:WLAN:SEMAsk:OFFSet[1]|2:LIST:STOP:ABSolute
```

```
[ :SENSe ] :LSEQuencer:WLAN:SEMask:OFFSet [1] | 2:LIST:STOP:ABSoluteCOUPle  
[ :SENSe ] :LSEQuencer:WLAN:SEMask:OFFSet [1] | 2:LIST:STARt:RCARrier  
[ :SENSe ] :LSEQuencer:WLAN:SEMask:OFFSet [1] | 2:LIST:STOP:RCARrier  
[ :SENSe ] :LSEQuencer:WLAN:SEMask:OFFSet [1] | 2:LIST:STOP:RCARrier:COUPle  
[ :SENSe ] :LSEQuencer:WLAN:SEMask:OFFSet [1] | 2:LIST:TEST  
[ :SENSe ] :LSEQuencer:WLAN:SEMask:FILTer [ :RRC ] [ :STATe ]  
[ :SENSe ] :LSEQuencer:WLAN:SEMask:FILTer [ :RRC ] :ALPHa  
[ :SENSe ] :LSEQuencer:WLAN:SEMask:LIMits  
[ :SENSe ] :LSEQuencer:WLAN:SEMask:TYPE  
:TRACe:LSEQuencer:WLAN:SEMask:TYPE
```

SEM results

Index	Result Parameter
0	Overall Pass/Fail result shows the mask test result (0 = pass, 1 = fail, -1 not tested)
1	<p data-bbox="451 415 586 441">Main Results</p> <ol data-bbox="451 457 1187 1461" style="list-style-type: none"> 1. Absolute power at center frequency (reference) area (dBm) 2. Peak Frequency in the center frequency (reference) area (Hz) 3. Relative integrated power on the negative offset A (dBc) 4. Absolute integrated power on the negative offset A (dBm or dBm/Hz) 5. Relative peak power on the negative offset A (dBc) 6. Absolute peak power on the negative offset A (dBm or dBm/Hz) 7. Peak power offset frequency from the center frequency in the negative offset A (Hz) 8. Relative integrated power on the positive offset A (dBc) 9. Absolute integrated power on the positive offset A (dBm or dBm/Hz) 10. Relative peak power on the positive offset A (dBc) 11. Absolute peak power on the positive offset A (dBm or dBm/Hz) 12. Peak power offset frequency from the center frequency in the positive offset A (Hz) 13. Relative integrated power on the negative offset B (dBc) ... 61. Absolute peak power on the positive offset F (dBm or dBm/Hz) 62. Peak power offset frequency from the center frequency in the positive offset F (Hz) 63. Minimum margin from limit line on the negative offset A (dB) 64. Minimum margin from limit line on the positive offset A (dB) 65. Minimum margin from limit line on the negative offset B (dB) 66. Minimum margin from limit line on the positive offset B (dB) 67. Minimum margin from limit line on the negative offset C (dB) 68. Minimum margin from limit line on the positive offset C (dB) 69. Minimum margin from limit line on the negative offset D (dB) 70. Minimum margin from limit line on the positive offset D (dB) 71. Minimum margin from limit line on the negative offset E (dB) 72. Minimum margin from limit line on the positive offset E (dB) 73. Minimum margin from limit line on the negative offset F (dB) 74. Minimum margin from limit line on the positive offset F (dB) <p data-bbox="451 1478 1235 1535">The unit for the absolute power results varies depending on the measurement type:</p> <p data-bbox="451 1551 1252 1608">If the measurement type is Total Power Reference, these results are expressed in dBm.</p> <p data-bbox="451 1625 1247 1682">If the measurement type is Power Spectral Density Reference, these results are expressed in dBm/Hz.</p>

Occupied Bandwidth (OBW)

This section provides the remote control SCPI commands for the WLAN Occupied Bandwidth (OBW) measurement from within the List Sequencer. This measurement is available only if you have the WLAN measurement application licensed on the test set.

For more detailed information about the OBW measurement, refer to the online help associated with the WLAN measurement application, which is also available in PDF format (“User’s and Programmer’s Reference”) on the Keysight website, www.keysight.com/find/e6650a.

You can also refer to the measurement guide for the X-series WLAN measurement application, which is available on the Keysight website, www.keysight.com/find/mxa.

OBW measurement SCPI commands

There is a set of SCPI commands available to program the WLAN OBW measurement when it is used in the WLAN mode. To set up the WLAN measurements from within the Sequence Analyzer mode you need to prefix the SCPI commands with `LSEQuencer:WLAN`. For example, the `[:SENSe]:OBWidth` part of the OBW SCPI commands are replaced with `[:SENSe]:LSEQuencer:WLAN:OBWidth`.

The following commands are used to set up the OBW measurement.

```
[:SENSe]:LSEQuencer:WLAN:OBWidth:BANDwidth[:RESolution]
```

```
[:SENSe]:LSEQuencer:WLAN:OBWidth:BANDwidth:SHAPE
```

```
[:SENSe]:LSEQuencer:WLAN:OBWidth:PERCent
```

```
[:SENSe]:LSEQuencer:WLAN:OBWidth:XDB
```

```
CALCulate: [SENSe]:LSEQuencer:WLAN:OBWidth:LIMit:FBLimit
```

```
CALCulate: [SENSe]:LSEQuencer:WLAN:OBWidth:LIMit[:TEST]
```

```
[:SENSe]:LSEQuencer:WLAN:OBWidth:FREQuency:SPAN
```

```
[:SENSe]:LSEQuencer:WLAN:OBWidth:FREQuency:SPAN:FULL
```

```
[:SENSe]:LSEQuencer:WLAN:OBWidth:FREQuency:SPAN:PREVIOUS
```

OBW results

Index	Result Parameter
0	Overall Pass/Fail
1	Main Results 1. Occupied Band width (Hz) 2. Transmit Frequency Error (Hz) 3. x dB band width (Hz)

Modulation Accuracy (EVM & Spectral Flatness)

This section provides the remote control SCPI commands for the WLAN Modulation Accuracy measurement from within the List Sequencer. This measurement is available only if you have the WLAN measurement application licensed on the test set.

For more detailed information about the Modulation Accuracy measurement, refer to the online help associated with the WLAN measurement application, which is also available in PDF format (“User’s and Programmer’s Reference”) on the Keysight website, www.keysight.com/find/e6650a.

You can also refer to the measurement guide for the X-series WLAN measurement application, which is available on the Keysight website, www.keysight.com/find/mxa.

Modulation Accuracy measurement SCPI commands

There is a set of SCPI commands available to program the WLAN Modulation Accuracy (EVM & Spectral Flatness) measurement when it is used in the WLAN mode. To set up the WLAN measurements from within the Sequence Analyzer mode you need to prefix the SCPI commands with `LSEQuencer:WLAN`.

For example, the `[:SENSe]:EVM` part of the EVM SCPI commands is replaced with:
`[:SENSe]:LSEQuencer:WLAN:EVM`.

Also, the `[:SENSe]:FLATness` part of the Spectral Flatness SCPI commands is replaced with:
`[:SENSe]:LSEQuencer:WLAN:FLATness`.

The following commands are used to set up the modulation accuracy measurement.

```
[:SENSe]:LSEQuencer:WLAN:EVM:TIME:INTERval <integer>
[:SENSe]:LSEQuencer:WLAN:EVM:TIME:OFFSet <integer>
[:SENSe]:LSEQuencer:WLAN:EVM:TIME:RESult[:STATe]:AUTO OFF|ON|0|1
[:SENSe]:LSEQuencer:WLAN:EVM:TIME:RESult:LENGth <integer>
[:SENSe]:LSEQuencer:WLAN:EVM:TIME:RESult:MAX <integer>
[:SENSe]:LSEQuencer:WLAN:EVM:TIME:RESult:SIG OFF|ON|0|1
:CALCulate:LSEQuencer:WLAN:EVM:SUBCarrier ALL|PILOt|SINGLE
:CALCulate:LSEQuencer:WLAN:EVM:SUBCarrier:COUNT <integer>
[:SENSe]:LSEQuencer:WLAN:EVM:FILTer:REFerence:TYPE GAUSSian|RECT|RC
[:SENSe]:LSEQuencer:WLAN:EVM:FILTer:ALPHa <real>
[:SENSe]:LSEQuencer:WLAN:EVM:FILTer:MEASurement:TYPE NONE|RRC
[:SENSe]:LSEQuencer:WLAN:EVM:SYMBOL:ADJust <percent>
[:SENSe]:LSEQuencer:WLAN:EVM:STSequence LONG|SHORT
:CALCulate:LSEQuencer:WLAN:EVM:PILOt:TRACk:AMPLitude OFF|ON|0|1
:CALCulate:LSEQuencer:WLAN:EVM:PILOt:TRACk:PHASe OFF|ON|0|1
:CALCulate:LSEQuencer:WLAN:EVM:PILOt:TRACk:TIMing OFF|ON|0|1
```

```
:CALCulate:LSEQuencer:WLAN:EVM:EQUalizer:TMODe SEQuence|SDATa
:CALCulate:LSEQuencer:WLAN:EVM:IQNorm OFF|ON|0|1
[:SENSe]:LSEQuencer:WLAN:EVM:COMPensate OFF|ON|0|1
:CALCulate:LSEQuencer:WLAN:EVM:SPECTrum INVert|NORMal
[:SENSe]:LSEQuencer:WLAN:EVM:CRATe <frequency>
[:SENSe]:LSEQuencer:WLAN:EVM:CADJust <real>
[:SENSe]:LSEQuencer:WLAN:EVM:EQUalizer[:STATe] OFF|ON|0|1
[:SENSe]:LSEQuencer:WLAN:EVM:EQUalizer:LENGth <integer>
[:SENSe]:LSEQuencer:WLAN:EVM:DESCramble ALL|NONE|PONLy|PHONLy
:CALCulate:LSEQuencer:WLAN:EVM:TRACk:PHASe OFF|ON|0|1
:CALCulate:LSEQuencer:WLAN:EVM:LIMit:RMS:M6 <rel_ampl>
:CALCulate:LSEQuencer:WLAN:EVM:LIMit:RMS:M9 <rel_ampl>
:CALCulate:LSEQuencer:WLAN:EVM:LIMit:RMS:M12 <rel_ampl>
:CALCulate:LSEQuencer:WLAN:EVM:LIMit:RMS:M18 <rel_ampl>
:CALCulate:LSEQuencer:WLAN:EVM:LIMit:RMS:M24 <rel_ampl>
:CALCulate:LSEQuencer:WLAN:EVM:LIMit:RMS:M36 <rel_ampl>
:CALCulate:LSEQuencer:WLAN:EVM:LIMit:RMS:M48 <rel_ampl>
:CALCulate:LSEQuencer:WLAN:EVM:LIMit:RMS:M54 <rel_ampl>
:CALCulate:LSEQuencer:WLAN:EVM:LIMit:FERRor <real>
:CALCulate:LSEQuencer:WLAN:EVM:LIMit:CLKerror <real>
:CALCulate:LSEQuencer:WLAN:EVM:LIMit:CFLeakage <rel_ampl>
:CALCulate:LSEQuencer:WLAN:EVM:LIMit:RMS:BPSK:R1B2 <rel_ampl>
:CALCulate:LSEQuencer:WLAN:EVM:LIMit:RMS:QPSK:R1B2 <rel_ampl>
:CALCulate:LSEQuencer:WLAN:EVM:LIMit:RMS:QPSK:R3B4 <rel_ampl>
:CALCulate:LSEQuencer:WLAN:EVM:LIMit:RMS:QA16:R1B2 <rel_ampl>
:CALCulate:LSEQuencer:WLAN:EVM:LIMit:RMS:QA16:R3B4 <rel_ampl>
:CALCulate:LSEQuencer:WLAN:EVM:LIMit:RMS:QA64:R2B3 <rel_ampl>
:CALCulate:LSEQuencer:WLAN:EVM:LIMit:RMS:QA64:R3B4 <rel_ampl>
:CALCulate:LSEQuencer:WLAN:EVM:LIMit:RMS:QA64:R5B5 <rel_ampl>
:CALCulate:LSEQuencer:WLAN:EVM:LIMit:RMS:QA256:R3B4 <rel_ampl>
:CALCulate:LSEQuencer:WLAN:EVM:LIMit:RMS:QA256:R5B6 <rel_ampl>
:CALCulate:LSEQuencer:WLAN:EVM:LIMit:RMS <percent>
```

WLAN Programming Commands
Modulation Accuracy (EVM & Spectral Flatness)

```
:CALCulate:LSEQuencer:WLAN:EVM:LIMit:CHIP <percent>  
:CALCulate:LSEQuencer:WLAN:EVM:LIMit:CARRier <rel_amp>  
:CALCulate:LSEQuencer:WLAN:FLATness:LIMit:UPPer:SECTion1 <rel_amp>  
:CALCulate:LSEQuencer:WLAN:FLATness:LIMit:LOWer:SECTion1 <rel_amp>  
:CALCulate:LSEQuencer:WLAN:FLATness:LIMit:UPPer:SECTion2 <rel_amp>  
:CALCulate:LSEQuencer:WLAN:FLATness:LIMit:LOWer:SECTion2 <rel_amp>
```

Modulation Accuracy (EVM & Spectral Flatness) results

Index	Result Parameter
0	Overall Pass/Fail Result 0:Pass, 1:Fail, -1:Not tested
1	RMS EVM pass/fail result (1.0 = fail, 0.0 = pass)
2	Frequency Error pass/fail result (1.0 = fail, 0.0 = pass)
3	Symbol Clock Error pass/fail result (1.0 = fail, 0.0 = pass)
4	Chip Clock Error pass/fail result (1.0 = fail, 0.0 = pass)
5	Carrier Suppression pass/fail result (1.0 = fail, 0.0 = pass)
6	IQ Offset pass/fail result (1.0 = fail, 0.0 = pass)
7	1000 Chips Peak EVM pass/fail (1.0 = fail, 0.0 = pass)
8	Spectral Flatness pass/fail (1.0 = fail, 0.0 = pass)
9	RMS EVM (Average) (dB)
10	Peak EVM (Peak Hold) (dB)
11	Frequency Error (Average) (Hz)
12	Symbol Clock Error (ppm)
13	Chip Clock Error (ppm)
14	Carrier Suppression (dB)
15	I/Q Origin Offset (dB)
16	802.11b 1000 Chips Peak Peak EVM (dB)
17	IQ Gain Imbalance (dB)
18	IQ Quadrature Error (degree)

MIMO Modulation Accuracy (EVM)

This section provides the remote control SCPI commands for the WLAN MIMO Modulation Accuracy (EVM) measurement from within the List Sequencer. This measurement is available only if you have the WLAN measurement application licensed on the test set.

For more detailed information about the MIMO Modulation Accuracy (EVM) measurement, refer to the online help associated with the WLAN measurement application, which is also available in PDF format (“User’s and Programmer’s Reference”) on the Keysight website, www.keysight.com/find/e6650a.

You can also refer to the measurement guide for the X-series WLAN measurement application, which is available on the Keysight website, www.keysight.com/find/mxa.

MIMO Modulation Accuracy measurement SCPI commands

There is a set of SCPI commands available to program the WLAN MIMO Modulation Accuracy measurement when it is used in the WLAN mode. To set up the WLAN measurements from within the Sequence Analyzer mode you need to prefix the SCPI commands with `LSEQuencer:WLAN`. For example, the `:CALCulate:EVMMimo` part of the MIMO Modulation Accuracy SCPI commands are replaced with `:CALCulate:LSEQuencer:WLAN:EVMMimo`.

The following commands are used to set up the MIMO EVM measurement.

```
:CALCulate:EVMMimo:LIMit:FERRor <real> :CALCulate:EVMMimo:LIMit:CLKerror
<real> :CALCulate:EVMMimo:LIMit:CFLeakage <rel_ampl>
:CALCulate:EVMMimo:LIMit:RMS:BPSK:R1B2 <rel_ampl>
:CALCulate:EVMMimo:LIMit:RMS:QPSK:R1B2 <rel_ampl>
:CALCulate:EVMMimo:LIMit:RMS:QPSK:R3B4 <rel_ampl>
:CALCulate:EVMMimo:LIMit:RMS:QA16:R1B2 <rel_ampl>
:CALCulate:EVMMimo:LIMit:RMS:QA16:R3B4 <rel_ampl>
:CALCulate:EVMMimo:LIMit:RMS:QA64:R2B3 <rel_ampl>
:CALCulate:EVMMimo:LIMit:RMS:QA64:R3B4 <rel_ampl>
:CALCulate:EVMMimo:LIMit:RMS:QA64:R5B6 <rel_ampl>
:CALCulate:EVMMimo:LIMit:RMS:QA256:R3B4 <rel_ampl>
:CALCulate:EVMMimo:LIMit:RMS:QA256:R5B6 <rel_ampl>
:CALCulate:EVMMimo:EQUalizer:TMODe SEQuence|SDATa
:CALCulate:EVMMimo:PILot:TRACk:AMPLitude OFF|ON|0|1
:CALCulate:EVMMimo:PILot:TRACk:PHASe OFF|ON|0|1
:CALCulate:EVMMimo:PILot:TRACk:TIMing OFF|ON|0|1
:CALCulate:EVMMimo:PILot:TRACk:MODE POSTeq|PREeq
[:SENSe]:EVMMimo:MTYPE DMAP|FOURier
```

MIMO Modulation Accuracy results

Index	Result Parameter
0	Overall Pass/Fail Result 0:Pass, 1:Fail, -1:Not tested
1	Stream 1 RMS EVM pass/fail result (1.0 = fail, 0.0 = pass, -1.0 = Not tested)
2	Stream 1 RMS EVM (dB)
3	Stream 1 Peak EVM (dB)
4	Stream 1 Pilot EVM (dB)
5	Stream 1 Data EVM (dB)
6	Stream 1 Chips Peak EVM (%)
7-18	7-12: Stream 2 (as in Index 1-6 above). 13-18: Stream 3 (as in Index 1-6 above)
19-24	Reserved
25	Channel 1 RMS EVM pass/fail result (1.0 = fail, 0.0 = pass, -1.0 = Not tested)
26	Channel 1 Frequency Error pass/fail result (1.0 = fail, 0.0 = pass, -1.0 = Not tested)
27	Channel 1 Symbol Clock Error pass/fail result (1.0 = fail, 0.0 = pass, -1.0 = Not tested)
28	Channel 1 IQ Offset pass/fail result (1.0 = fail, 0.0 = pass, -1.0 = Not tested)
29	Channel 1 RMS EVM (dB)
30	Channel 1 Peak EVM (dB)
31	Channel 1 Pilot EVM (dB)
32	Channel 1 Data EVM (dB)
33	Channel 1 Frequency Error (Hz)
34	Channel 1 Symbol Clock Error (ppm)
35	Channel 1 IQ Gain Imbalance (dB)
36	Channel 1 IQ Offset (dB)
37	Channel 1 IQ Quadrature Error (deg)s
38	Channel 1 IQ Timing Skew (pps)
39	Channel 1 Cross Power (dB)
40	Channel 1 Sync Corr
41-72	41-56: Channel 2 (as in Index 25-40 above). 57-72: Channel 3 (as in Index 25-40 above)
73-88	Reserved

WLAN Programming Commands
MIMO Modulation Accuracy (EVM)